

### Analog Peripherals

#### 10-Bit ADC

- Programmable throughput up to 200 ksp/s
- Up to 21 external inputs; programmable as single-ended or differential
- Reference from internal  $V_{REF}$ ,  $V_{DD}$ , or external pin
- Internal or external start of conversion sources
- Built-in temperature sensor ( $\pm 3^\circ\text{C}$ )

#### 10-bit DAC (Current Mode)

#### Two Comparators

- Programmable hysteresis and response time
- Configurable to generate interrupts or reset
- Low current

### On-Chip Debug

- On-chip debug circuitry facilitates full speed, non-intrusive in-system debug (no emulator required)
- Provides breakpoints, single stepping, watchpoints
- Inspect/modify memory, registers, and stack
- Superior performance to emulation systems using ICE-chips, target pods, and sockets

**Supply Voltage: 2.7 to 3.6 V**

**Temperature Range:  $-40$  to  $+85^\circ\text{C}$**

### High-Speed 8051 $\mu\text{C}$ Core

- Pipelined instruction architecture; executes 70% of instructions in 1 or 2 system clocks
- Up to 50 MIPS throughput with 50 MHz system clock
- 16 x 16 multiply/accumulate engine (2-cycle)

### Memory

- 1280 bytes data RAM
- 16 kB Flash; in-system programmable in 512 byte sectors (512 bytes are reserved)

### Digital Peripherals

- 29 port I/O; all are 5 V tolerant
- Hardware SMBus™ (I2C™ compatible), SPI™, and UART serial ports available concurrently
- Programmable 16-bit counter/timer array with six capture/compare modules, WDT
- 4 general-purpose 16-bit counter/timers
- Real-time clock mode using PCA or timer and external clock source

### Clock Sources

- Two internal oscillators:
  - 24.5 MHz, 2% accuracy supports UART operation
  - 80 kHz low frequency, low-power
- External oscillator: Crystal, RC, C, or Clock (1 or 2 pin modes)
- On-Chip programmable PLL: up to 50 MHz

### Package

- 32-pin LQFP
- Pin compatible with C8051F310

### Ordering Part Number

- C8051F368-GQ

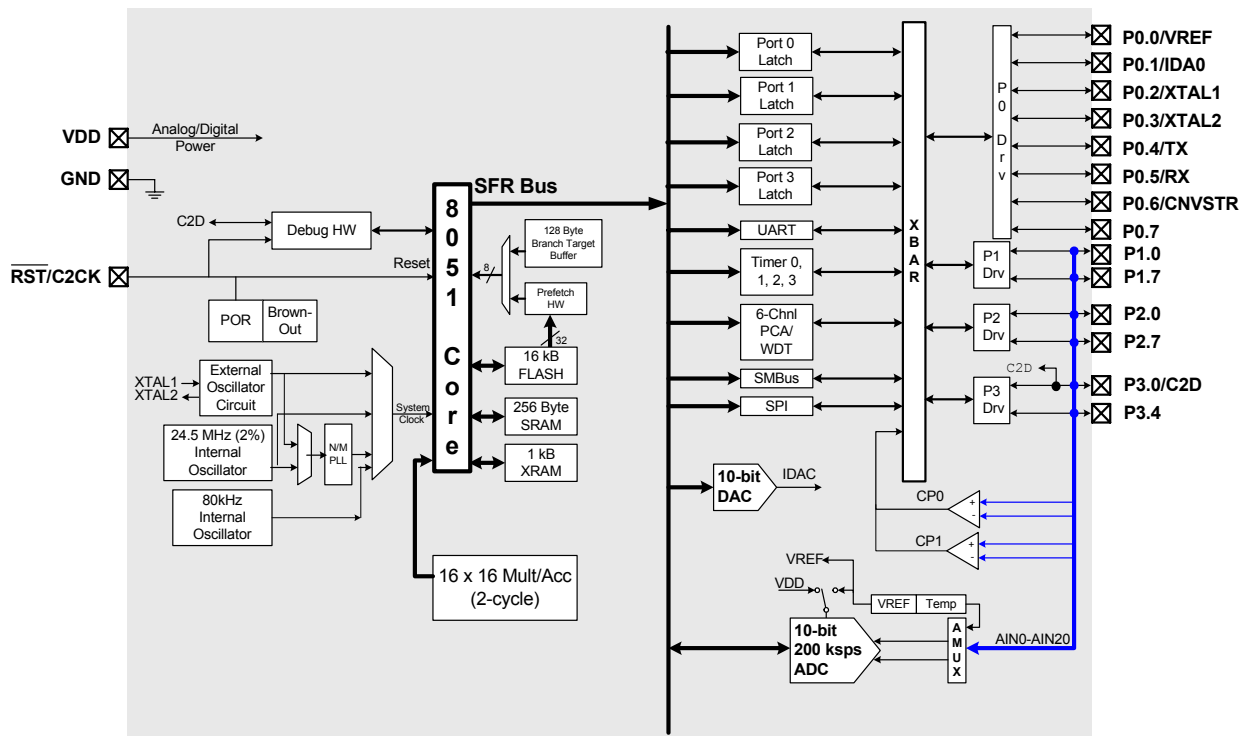

## Selected Electrical Specifications

( $T_A = -40$  to  $+85$  C°,  $V_{DD} = 2.7$  V unless otherwise specified)

Parameter	Conditions	Min	Typ	Max	Units
<b>Global Characteristics</b>					
Supply Voltage		2.7	—	3.6	V
Supply Current with CPU active	Clock = 100 MHz	—	TBD	—	mA
	Clock = 25 MHz	—	TBD	—	mA
	Clock = 1 MHz	—	TBD	—	μA
	Clock = 80 kHz; $V_{DD}$ Monitor Disabled Clock = 32 kHz; $V_{DD}$ Monitor Disabled	—	TBD	—	μA
Supply Current (shutdown)	Oscillator off; $V_{DD}$ Monitor Disabled	—	<0.1	—	μA
Clock Frequency Range		DC	—	100	MHz
<b>Internal Oscillators</b>					
Frequency (OSC0)		24.0	24.5	25.0	MHz
Frequency (OSC1)	OSC1 can be calibrated in 2.5% steps using an internal calibration register.	—	80	—	kHz
<b>A/D Converter</b>					
Resolution			10		bits
Integral Nonlinearity		TBD	±0.5	TBD	LSB
Differential Nonlinearity	Guaranteed Monotonic	TBD	±0.5	TBD	LSB
Signal-to-Noise Plus Distortion		TBD	TBD	—	dB
Throughput Rate		—	—	200	ksps
Input Voltage Range		0	—	$V_{REF}$	V
<b>D/A Converter</b>					
Resolution			10		bits
Integral Nonlinearity		—	±0.5	TBD	LSB
Differential Nonlinearity	Guaranteed Monotonic	—	±0.5	TBD	LSB
Output Settling Time		—	5	—	μs
<b>Comparator</b>					
Response Time Mode0	(CP+) – (CP-) = 100 mV	—	100	—	ns
Current Consumption Mode0		—	TBD	—	μA
Response Time Mode1	(CP+) – (CP-) = 100 mV	—	175	—	ns
Current Consumption Mode1		—	TBD	—	μA
Response Time Mode2	(CP+) – (CP-) = 100 mV	—	320	—	ns
Current Consumption Mode2		—	TBD	—	μA
Response Time Mode3	(CP+) – (CP-) = 100 mV	—	1050	—	ns
Current Consumption Mode3		—	TBD	—	μA

## Package Information

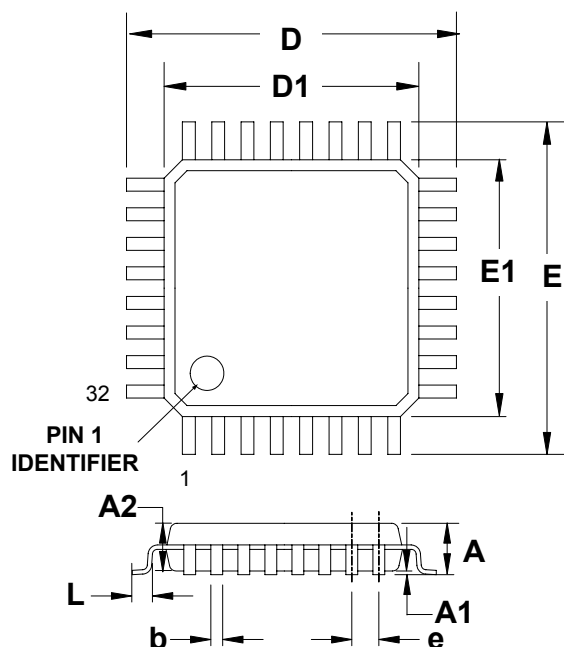

## C8051F360DK Development Kit

