

Analog Peripherals

10-Bit ADC

- ± 1 LSB INL; no missing codes
- Programmable throughput up to 200 ksp/s
- Up to 17 external inputs; programmable as single-ended or differential
- Built-in temperature sensor (± 3 °C)

Two Comparators

Internal Voltage Reference: 2.4 V

POR/Brown-out Detector

USB Function Controller

- USB specification 2.0 compliant
- Full-speed (12 Mbps) or low-speed (1.5 Mbps) operation
- Integrated clock recovery; no external crystal required for either full-speed or low-speed operation
- Supports eight flexible endpoints
- Dedicated 1 kB USB buffer memory
- Integrated transceiver; no external resistors required

On-Chip Debug

- On-chip debug circuitry facilitates full speed, non-intrusive in-system debug (no emulator required)
- Provides breakpoints, single stepping
- Inspect/modify memory, registers, and USB memory
- Superior performance to emulation systems using ICE-chips, target pods, and sockets

Temperature Range: -40 to +85 °C

High-Speed 8051 μ C Core

- Pipelined instruction architecture; executes 70% of instructions in 1 or 2 system clocks
- Up to 25 MIPS throughput with 25 MHz Clock
- Expanded interrupt handler

Memory

- 2304 bytes data RAM (256 + 2 kB)
- 32 kB Flash; in-system programmable in 512-byte sectors (512 bytes are reserved)
- External parallel data memory interface

Digital Peripherals

- 40 port I/O; all are 5 V tolerant
- Hardware SMBus™ (I²C™ compatible), SPI™, and 2 UART serial ports available concurrently
- 4 general-purpose 16-bit counter/timers
- Programmable 16-bit counter array with 5 capture/compare modules

Clock Sources

- Internal oscillator: 0.25% accuracy with clock recovery enabled; supports all USB and UART modes
- External oscillator: Crystal, RC, C, or Clock
- On-chip clock multiplier: up to 48 MHz

Voltage Regulator

- On-chip voltage regulator supports USB bus-powered operation
- Regulator bypass mode supports USB self-powered operation

Operating Voltage: 2.7 to 5.25 V

Package

- 48-Pin TQFP (lead-free package)

Ordering Part Number

- C8051F345-GQ

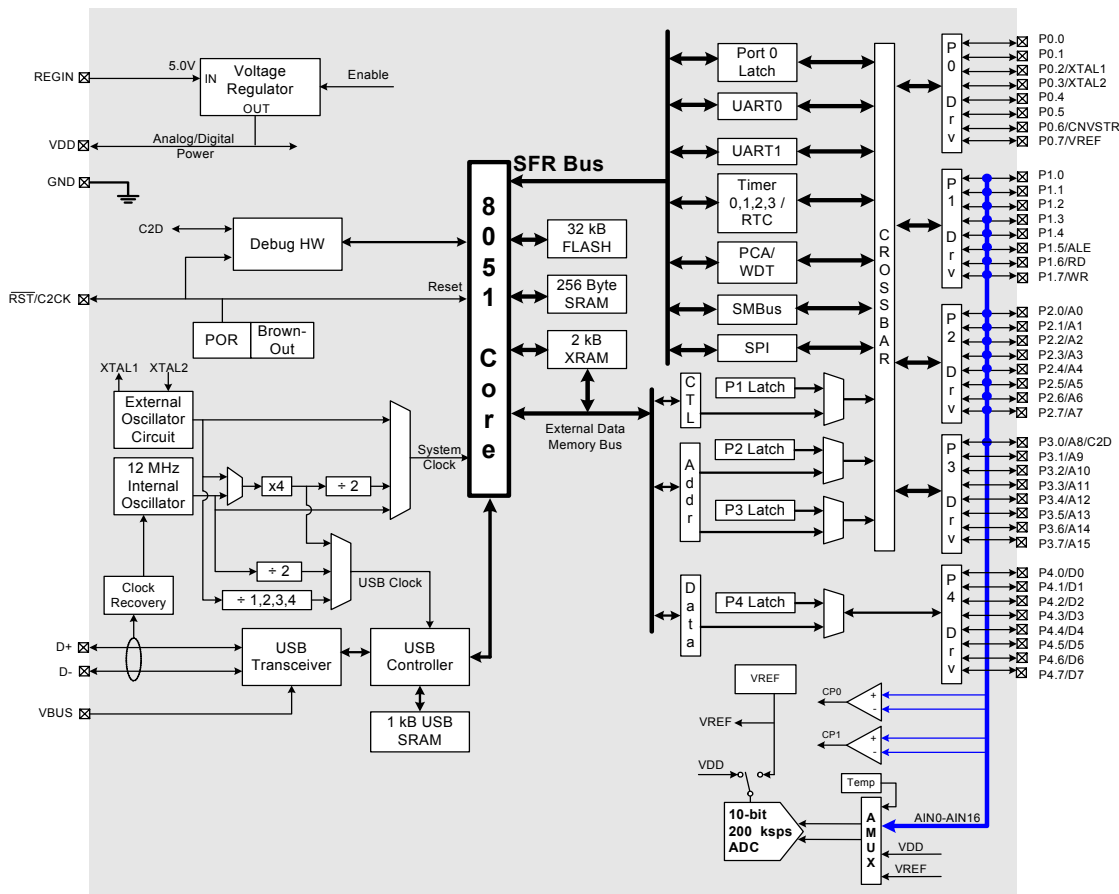

Selected Electrical Specifications

($T_A = 0$ to $+70$ C°, $V_{REG} = 5.0$ V unless otherwise specified)

Parameter	Conditions	Min	Typ	Max	Units
Global Characteristics					
Regulator Input Voltage (REGIN)		4.0	—	5.25	V
V_{DD} (VREG Output)		3.0	3.3	3.6	V
V_{REG} Bias Current	V_{REG} Enabled	—	90	—	μ A
Supply Current with CPU and USB active	CPU Clock = 24 MHz, USB Clock = 48 MHz	—	18	—	mA
	CPU Clock = 12 MHz, USB Clock = 6 MHz	—	9	—	mA
Supply Current (suspend mode, Oscillator off)	V_{DD} Monitor Enabled; V_{REG} Disabled	—	30	—	μ A
	V_{DD} Monitor Disabled; V_{REG} Disabled	—	<0.1	—	μ A
CPU System Clock Range		DC	—	25	MHz
Internal Oscillator & Clocks					
Frequency	Clock Recovery Enabled	11.97	12.0	12.03	MHz
	Clock Recovery Disabled	11.82	12.0	12.18	MHz
USB Clock	Full-Speed Operation	47.88	48.0	48.12	MHz
	Low-Speed Operation	5.91	6.0	6.09	MHz
A/D Converter					
Resolution		10			bits
Integral Nonlinearity		—	$\pm 1/2$	± 1	LSB
Differential Nonlinearity	Guaranteed Monotonic	—	$\pm 1/2$	± 1	LSB
Signal-to-Noise Plus Distortion		51	—	—	dB
Throughput Rate		—	—	200	ksps
Input Voltage Range		0	—	V_{REF}	V
Comparator					
Response Time Mode0	(CP+) – (CP-) = 100 mV	—	0.1	—	μ s
Current Consumption Mode0		—	7.6	—	μ A
Response Time Mode1	(CP+) – (CP-) = 100 mV	—	0.18	—	μ s
Current Consumption Mode1		—	3.2	—	μ A
Response Time Mode2	(CP+) – (CP-) = 100 mV	—	0.32	—	μ s
Current Consumption Mode2		—	1.3	—	μ A
Response Time Mode3	(CP+) – (CP-) = 100 mV	—	1	—	μ s
Current Consumption Mode3		—	0.4	—	μ A

Package Information

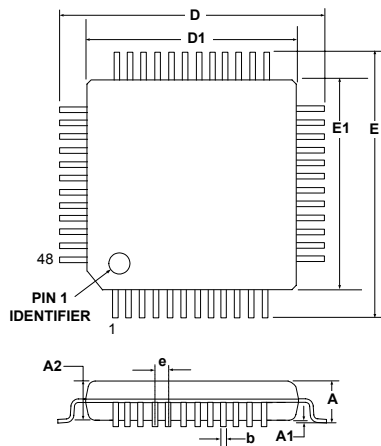

	MIN (mm)	NOM (mm)	MAX (mm)
A	-	-	1.20
A1	0.05	-	0.15
A2	0.95	1.00	1.05
b	0.17	0.22	0.27
D	-	9.00	-
D1	-	7.00	-
e	-	0.50	-
E	-	9.00	-
E1	-	7.00	-

C8051F340DK Development Kit

