

Analog Peripherals

10-Bit ADC

- ± 1 LSB INL; no missing codes
- Programmable throughput up to 100 ksp/s
- 8 external inputs; programmable as single-ended or differential
- Programmable amplifier gain: 16, 8, 4, 2, 1, 0.5
- Data-dependent windowed interrupt generator
- Built-in temperature sensor (± 3 °C)

Two Comparators

Internal Voltage Reference

V_{DD} Monitor/Brown-out Detector

On-Chip JTAG Debug & Boundary Scan

- On-chip debug circuitry facilitates full speed, non-intrusive in-system debug (no emulator required)
- Provides breakpoints, single stepping, watchpoints, stack monitor
- Inspect/modify memory and registers
- Superior performance to emulation systems using ICE-chips, target pods, and sockets
- IEEE1149.1 compliant boundary scan

High-Speed 8051 μ C Core

- Pipelined instruction architecture; executes 70% of instructions in 1 or 2 system clocks
- Up to 100 MIPS throughput with 100 MHz system clock
- 16 x 16 multiply/accumulate engine (2-cycle)

Memory

- 8448 bytes data RAM
- 64 kB Flash; in-system programmable in 1024-byte sectors (1024 bytes are reserved)
- External parallel data memory interface

Digital Peripherals

- 32 port I/O; all are 5 V tolerant
- Hardware SMBus™ (I2C™ Compatible), SPI™, and two UART serial ports available concurrently
- Programmable 16-bit counter/timer array with six capture/compare modules
- 5 general-purpose 16-bit counter/timers
- Dedicated watchdog timer; bidirectional reset
- Real-time clock mode using Timer 3 or PCA

Clock Sources

- Internal oscillator: 24.5 MHz, 2% accuracy supports UART operation
- On-chip programmable PLL: up to 100 MHz
- External oscillator: Crystal, RC, C, or Clock

Supply Voltage: 3.0 to 3.6 V

- Typical operating current: 50 mA at 100 MHz
- Typical stop mode current: 0.4 μ A

64-Pin TQFP

Temperature Range: -40 to +85 °C

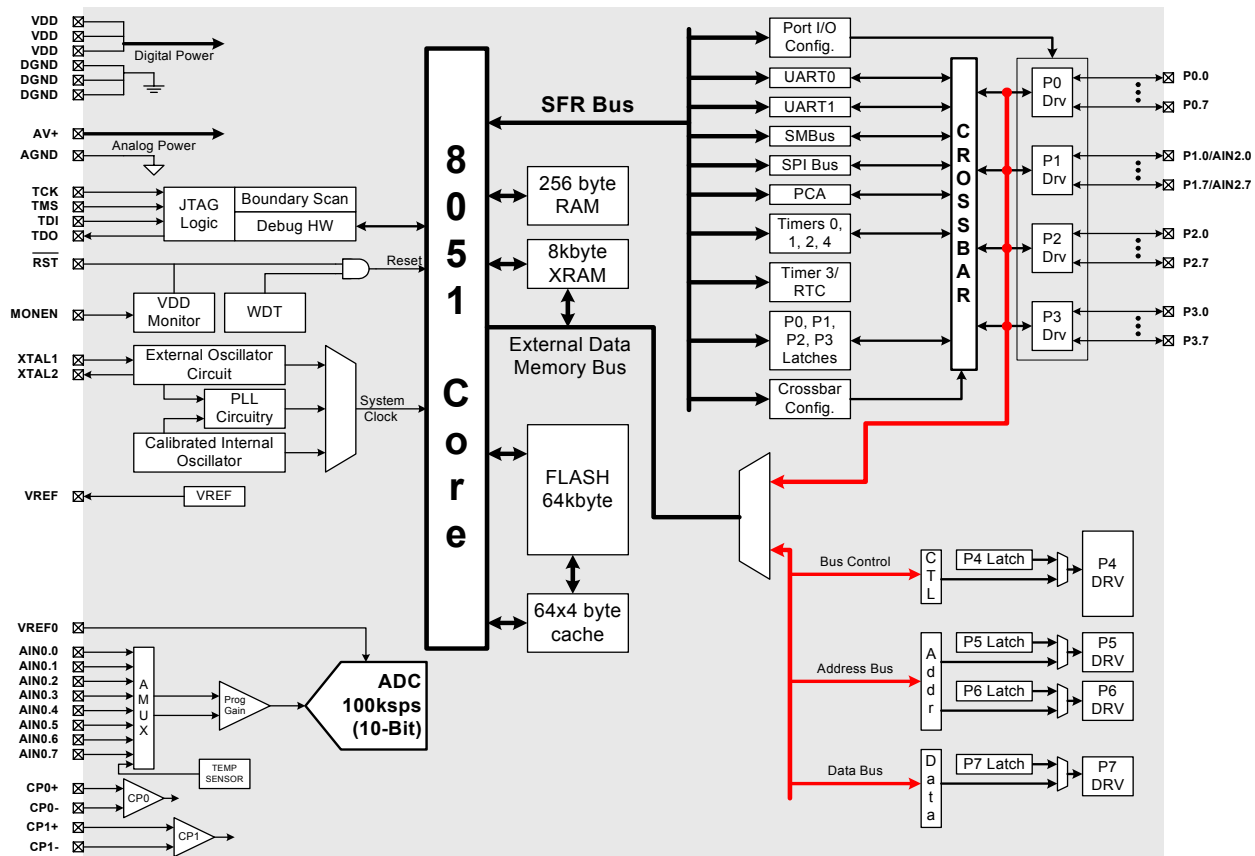

Selected Electrical Specifications

($T_A = -40$ to $+85$ C°, $V_{DD} = 3.0$ V unless otherwise specified)

PARAMETER	CONDITIONS	MIN	TYP	MAX	UNITS
GLOBAL CHARACTERISTICS					
Supply Voltage		3.0	—	3.6	V
Supply Current (CPU active)	Clock = 100 MHz	—	50	—	mA
	Clock = 1 MHz	—	0.6	—	mA
	Clock = 32 kHz	—	16	—	μ A
Supply Current (shutdown)	Oscillator off; V_{DD} Monitor Enabled	—	10	—	μ A
	Oscillator off; V_{DD} Monitor Disabled	—	0.4	—	μ A
Clock Frequency Range		DC	—	100	MHz
INTERNAL CLOCKS					
Oscillator Frequency		24.0	24.5	25.0	MHz
PLL Frequency		—	—	100	MHz
A/D CONVERTER					
Resolution			10		bits
Integral Nonlinearity		—	—	± 1	LSB
Differential Nonlinearity	Guaranteed Monotonic	—	—	± 1	LSB
Signal-to-Noise Plus Distortion		59	—	—	dB
Throughput Rate		—	—	100	ksps

Package Information

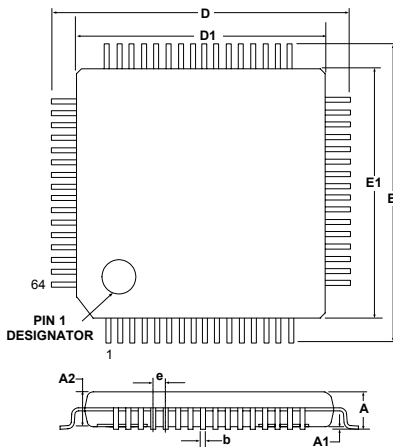

	MIN (mm)	NOM (mm)	MAX (mm)
A	-	-	1.20
A1	0.05	-	0.15
A2	0.95	-	1.05
b	0.17	0.22	0.27
D	-	12.00	-
D1	-	10.00	-
e	-	0.50	-
E	-	12.00	-
E1	-	10.00	-

C8051F120DK Development Kit

