



LUMINARY MICRO[®]

LM3S828 Microcontroller

DATA SHEET

Legal Disclaimers and Trademark Information

INFORMATION IN THIS DOCUMENT IS PROVIDED IN CONNECTION WITH LUMINARY MICRO PRODUCTS. NO LICENSE, EXPRESS OR IMPLIED, BY ESTOPPEL OR OTHERWISE, TO ANY INTELLECTUAL PROPERTY RIGHTS IS GRANTED BY THIS DOCUMENT. EXCEPT AS PROVIDED IN LUMINARY MICRO'S TERMS AND CONDITIONS OF SALE FOR SUCH PRODUCTS, LUMINARY MICRO ASSUMES NO LIABILITY WHATSOEVER, AND LUMINARY MICRO DISCLAIMS ANY EXPRESS OR IMPLIED WARRANTY, RELATING TO SALE AND/OR USE OF LUMINARY MICRO'S PRODUCTS INCLUDING LIABILITY OR WARRANTIES RELATING TO FITNESS FOR A PARTICULAR PURPOSE, MERCHANTABILITY, OR INFRINGEMENT OF ANY PATENT, COPYRIGHT OR OTHER INTELLECTUAL PROPERTY RIGHT. LUMINARY MICRO'S PRODUCTS ARE NOT INTENDED FOR USE IN MEDICAL, LIFE SAVING, OR LIFE-SUSTAINING APPLICATIONS.

Luminary Micro may make changes to specifications and product descriptions at any time, without notice. Contact your local Luminary Micro sales office or your distributor to obtain the latest specifications before placing your product order.

Designers must not rely on the absence or characteristics of any features or instructions marked "reserved" or "undefined." Luminary Micro reserves these for future definition and shall have no responsibility whatsoever for conflicts or incompatibilities arising from future changes to them.

Copyright © 2007-2008 Luminary Micro, Inc. All rights reserved. Stellaris, Luminary Micro, and the Luminary Micro logo are registered trademarks of Luminary Micro, Inc. or its subsidiaries in the United States and other countries. ARM and Thumb are registered trademarks and Cortex is a trademark of ARM Limited. Other names and brands may be claimed as the property of others.

Luminary Micro, Inc.
108 Wild Basin, Suite 350
Austin, TX 78746
Main: +1-512-279-8800
Fax: +1-512-279-8879
<http://www.luminarymicro.com>



LUMINARY MICRO



Cortex
Intelligent Processors by ARM[®]

Table of Contents

About This Document	16
Audience	16
About This Manual	16
Related Documents	16
Documentation Conventions	16
1 Architectural Overview	19
1.1 Product Features	19
1.2 Target Applications	23
1.3 High-Level Block Diagram	23
1.4 Functional Overview	24
1.4.1 ARM Cortex™-M3	25
1.4.2 Motor Control Peripherals	25
1.4.3 Analog Peripherals	26
1.4.4 Serial Communications Peripherals	26
1.4.5 System Peripherals	27
1.4.6 Memory Peripherals	28
1.4.7 Additional Features	28
1.4.8 Hardware Details	29
1.4.9 System Block Diagram	30
2 ARM Cortex-M3 Processor Core	31
2.1 Block Diagram	32
2.2 Functional Description	32
2.2.1 Serial Wire and JTAG Debug	32
2.2.2 Embedded Trace Macrocell (ETM)	33
2.2.3 Trace Port Interface Unit (TPIU)	33
2.2.4 ROM Table	33
2.2.5 Memory Protection Unit (MPU)	33
2.2.6 Nested Vectored Interrupt Controller (NVIC)	33
3 Memory Map	37
4 Interrupts	39
5 JTAG Interface	41
5.1 Block Diagram	42
5.2 Functional Description	42
5.2.1 JTAG Interface Pins	43
5.2.2 JTAG TAP Controller	44
5.2.3 Shift Registers	45
5.2.4 Operational Considerations	45
5.3 Initialization and Configuration	46
5.4 Register Descriptions	47
5.4.1 Instruction Register (IR)	47
5.4.2 Data Registers	49
6 System Control	51
6.1 Functional Description	51
6.1.1 Device Identification	51

6.1.2	Reset Control	51
6.1.3	Power Control	54
6.1.4	Clock Control	54
6.1.5	System Control	57
6.2	Initialization and Configuration	58
6.3	Register Map	58
6.4	Register Descriptions	59
7	Internal Memory	108
7.1	Block Diagram	108
7.2	Functional Description	108
7.2.1	SRAM Memory	108
7.2.2	Flash Memory	109
7.3	Flash Memory Initialization and Configuration	111
7.3.1	Changing Flash Protection Bits	111
7.3.2	Flash Programming	112
7.4	Register Map	112
7.5	Flash Register Descriptions (Flash Control Offset)	113
7.6	Flash Register Descriptions (System Control Offset)	120
8	General-Purpose Input/Outputs (GPIOs)	124
8.1	Block Diagram	125
8.2	Functional Description	125
8.2.1	Data Control	126
8.2.2	Interrupt Control	127
8.2.3	Mode Control	128
8.2.4	Pad Control	128
8.2.5	Identification	128
8.3	Initialization and Configuration	128
8.4	Register Map	129
8.5	Register Descriptions	131
9	General-Purpose Timers	163
9.1	Block Diagram	163
9.2	Functional Description	164
9.2.1	GPTM Reset Conditions	164
9.2.2	32-Bit Timer Operating Modes	165
9.2.3	16-Bit Timer Operating Modes	166
9.3	Initialization and Configuration	170
9.3.1	32-Bit One-Shot/Periodic Timer Mode	170
9.3.2	32-Bit Real-Time Clock (RTC) Mode	171
9.3.3	16-Bit One-Shot/Periodic Timer Mode	171
9.3.4	16-Bit Input Edge Count Mode	172
9.3.5	16-Bit Input Edge Timing Mode	172
9.3.6	16-Bit PWM Mode	173
9.4	Register Map	173
9.5	Register Descriptions	174
10	Watchdog Timer	199
10.1	Block Diagram	199
10.2	Functional Description	199

10.3	Initialization and Configuration	200
10.4	Register Map	200
10.5	Register Descriptions	201
11	Analog-to-Digital Converter (ADC)	222
11.1	Block Diagram	223
11.2	Functional Description	223
11.2.1	Sample Sequencers	223
11.2.2	Module Control	224
11.2.3	Hardware Sample Averaging Circuit	225
11.2.4	Analog-to-Digital Converter	225
11.2.5	Differential Sampling	225
11.2.6	Test Modes	227
11.2.7	Internal Temperature Sensor	227
11.3	Initialization and Configuration	228
11.3.1	Module Initialization	228
11.3.2	Sample Sequencer Configuration	228
11.4	Register Map	228
11.5	Register Descriptions	229
12	Universal Asynchronous Receivers/Transmitters (UARTs)	255
12.1	Block Diagram	256
12.2	Functional Description	256
12.2.1	Transmit/Receive Logic	256
12.2.2	Baud-Rate Generation	257
12.2.3	Data Transmission	257
12.2.4	FIFO Operation	258
12.2.5	Interrupts	258
12.2.6	Loopback Operation	259
12.3	Initialization and Configuration	259
12.4	Register Map	260
12.5	Register Descriptions	261
13	Synchronous Serial Interface (SSI)	294
13.1	Block Diagram	294
13.2	Functional Description	294
13.2.1	Bit Rate Generation	295
13.2.2	FIFO Operation	295
13.2.3	Interrupts	295
13.2.4	Frame Formats	296
13.3	Initialization and Configuration	303
13.4	Register Map	304
13.5	Register Descriptions	305
14	Inter-Integrated Circuit (I²C) Interface	331
14.1	Block Diagram	331
14.2	Functional Description	331
14.2.1	I ² C Bus Functional Overview	332
14.2.2	Available Speed Modes	334
14.2.3	Interrupts	335
14.2.4	Loopback Operation	335

14.2.5	Command Sequence Flow Charts	336
14.3	Initialization and Configuration	342
14.4	I ² C Register Map	343
14.5	Register Descriptions (I ² C Master)	344
14.6	Register Descriptions (I2C Slave)	357
15	Pin Diagram	366
16	Signal Tables	367
17	Operating Characteristics	373
18	Electrical Characteristics	374
18.1	DC Characteristics	374
18.1.1	Maximum Ratings	374
18.1.2	Recommended DC Operating Conditions	374
18.1.3	On-Chip Low Drop-Out (LDO) Regulator Characteristics	375
18.1.4	Power Specifications	375
18.1.5	Flash Memory Characteristics	376
18.2	AC Characteristics	376
18.2.1	Load Conditions	376
18.2.2	Clocks	376
18.2.3	Analog-to-Digital Converter	377
18.2.4	I ² C	377
18.2.5	Synchronous Serial Interface (SSI)	378
18.2.6	JTAG and Boundary Scan	380
18.2.7	General-Purpose I/O	381
18.2.8	Reset	382
19	Package Information	385
A	Serial Flash Loader	387
A.1	Serial Flash Loader	387
A.2	Interfaces	387
A.2.1	UART	387
A.2.2	SSI	387
A.3	Packet Handling	388
A.3.1	Packet Format	388
A.3.2	Sending Packets	388
A.3.3	Receiving Packets	388
A.4	Commands	389
A.4.1	COMMAND_PING (0X20)	389
A.4.2	COMMAND_GET_STATUS (0x23)	389
A.4.3	COMMAND_DOWNLOAD (0x21)	389
A.4.4	COMMAND_SEND_DATA (0x24)	390
A.4.5	COMMAND_RUN (0x22)	390
A.4.6	COMMAND_RESET (0x25)	390
B	Register Quick Reference	392
C	Ordering and Contact Information	405
C.1	Ordering Information	405
C.2	Kits	405
C.3	Company Information	406

C.4 Support Information 406

List of Figures

Figure 1-1.	Stellaris® 800 Series High-Level Block Diagram	24
Figure 1-2.	LM3S828 Controller System-Level Block Diagram	30
Figure 2-1.	CPU Block Diagram	32
Figure 2-2.	TPIU Block Diagram	33
Figure 5-1.	JTAG Module Block Diagram	42
Figure 5-2.	Test Access Port State Machine	45
Figure 5-3.	IDCODE Register Format	49
Figure 5-4.	BYPASS Register Format	49
Figure 5-5.	Boundary Scan Register Format	50
Figure 6-1.	External Circuitry to Extend Reset	52
Figure 6-2.	Main Clock Tree	55
Figure 7-1.	Flash Block Diagram	108
Figure 8-1.	GPIO Module Block Diagram	125
Figure 8-2.	GPIO Port Block Diagram	126
Figure 8-3.	GPIODATA Write Example	127
Figure 8-4.	GPIODATA Read Example	127
Figure 9-1.	GPTM Module Block Diagram	164
Figure 9-2.	16-Bit Input Edge Count Mode Example	168
Figure 9-3.	16-Bit Input Edge Time Mode Example	169
Figure 9-4.	16-Bit PWM Mode Example	170
Figure 10-1.	WDT Module Block Diagram	199
Figure 11-1.	ADC Module Block Diagram	223
Figure 11-2.	Differential Sampling Range, $V_{IN_ODD} = 1.5\text{ V}$	226
Figure 11-3.	Differential Sampling Range, $V_{IN_ODD} = 0.75\text{ V}$	226
Figure 11-4.	Differential Sampling Range, $V_{IN_ODD} = 2.25\text{ V}$	227
Figure 11-5.	Internal Temperature Sensor Characteristic	227
Figure 12-1.	UART Module Block Diagram	256
Figure 12-2.	UART Character Frame	257
Figure 13-1.	SSI Module Block Diagram	294
Figure 13-2.	TI Synchronous Serial Frame Format (Single Transfer)	297
Figure 13-3.	TI Synchronous Serial Frame Format (Continuous Transfer)	297
Figure 13-4.	Freescall SPI Format (Single Transfer) with SPO=0 and SPH=0	298
Figure 13-5.	Freescall SPI Format (Continuous Transfer) with SPO=0 and SPH=0	298
Figure 13-6.	Freescall SPI Frame Format with SPO=0 and SPH=1	299
Figure 13-7.	Freescall SPI Frame Format (Single Transfer) with SPO=1 and SPH=0	300
Figure 13-8.	Freescall SPI Frame Format (Continuous Transfer) with SPO=1 and SPH=0	300
Figure 13-9.	Freescall SPI Frame Format with SPO=1 and SPH=1	301
Figure 13-10.	MICROWIRE Frame Format (Single Frame)	302
Figure 13-11.	MICROWIRE Frame Format (Continuous Transfer)	303
Figure 13-12.	MICROWIRE Frame Format, SSIFss Input Setup and Hold Requirements	303
Figure 14-1.	I ² C Block Diagram	331
Figure 14-2.	I ² C Bus Configuration	332
Figure 14-3.	START and STOP Conditions	332
Figure 14-4.	Complete Data Transfer with a 7-Bit Address	333
Figure 14-5.	R/S Bit in First Byte	333

Figure 14-6.	Data Validity During Bit Transfer on the I ² C Bus	333
Figure 14-7.	Master Single SEND	336
Figure 14-8.	Master Single RECEIVE	337
Figure 14-9.	Master Burst SEND	338
Figure 14-10.	Master Burst RECEIVE	339
Figure 14-11.	Master Burst RECEIVE after Burst SEND	340
Figure 14-12.	Master Burst SEND after Burst RECEIVE	341
Figure 14-13.	Slave Command Sequence	342
Figure 15-1.	48-Pin QFP Package Pin Diagram	366
Figure 18-1.	Load Conditions	376
Figure 18-2.	I ² C Timing	378
Figure 18-3.	SSI Timing for TI Frame Format (FRF=01), Single Transfer Timing Measurement	379
Figure 18-4.	SSI Timing for MICROWIRE Frame Format (FRF=10), Single Transfer	379
Figure 18-5.	SSI Timing for SPI Frame Format (FRF=00), with SPH=1	380
Figure 18-6.	JTAG Test Clock Input Timing	381
Figure 18-7.	JTAG Test Access Port (TAP) Timing	381
Figure 18-8.	JTAG TRST Timing	381
Figure 18-9.	External Reset Timing (\overline{RST})	382
Figure 18-10.	Power-On Reset Timing	383
Figure 18-11.	Brown-Out Reset Timing	383
Figure 18-12.	Software Reset Timing	383
Figure 18-13.	Watchdog Reset Timing	384
Figure 18-14.	LDO Reset Timing	384
Figure 19-1.	48-Pin LQFP Package	385

List of Tables

Table 1.	Documentation Conventions	16
Table 3-1.	Memory Map	37
Table 4-1.	Exception Types	39
Table 4-2.	Interrupts	40
Table 5-1.	JTAG Port Pins Reset State	43
Table 5-2.	JTAG Instruction Register Commands	47
Table 6-1.	System Control Register Map	58
Table 6-2.	PLL Mode Control	72
Table 7-1.	Flash Protection Policy Combinations	109
Table 7-2.	Flash Register Map	112
Table 8-1.	GPIO Pad Configuration Examples	128
Table 8-2.	GPIO Interrupt Configuration Example	129
Table 8-3.	GPIO Register Map	130
Table 9-1.	Available CCP Pins	164
Table 9-2.	16-Bit Timer With Prescaler Configurations	167
Table 9-3.	Timers Register Map	173
Table 10-1.	Watchdog Timer Register Map	200
Table 11-1.	Samples and FIFO Depth of Sequencers	223
Table 11-2.	Differential Sampling Pairs	225
Table 11-3.	ADC Register Map	228
Table 12-1.	UART Register Map	260
Table 13-1.	SSI Register Map	304
Table 14-1.	Examples of I ² C Master Timer Period versus Speed Mode	334
Table 14-2.	Inter-Integrated Circuit (I ² C) Interface Register Map	343
Table 14-3.	Write Field Decoding for I2CMCS[3:0] Field (Sheet 1 of 3)	348
Table 16-1.	Signals by Pin Number	367
Table 16-2.	Signals by Signal Name	369
Table 16-3.	Signals by Function, Except for GPIO	371
Table 16-4.	GPIO Pins and Alternate Functions	372
Table 17-1.	Temperature Characteristics	373
Table 17-2.	Thermal Characteristics	373
Table 18-1.	Maximum Ratings	374
Table 18-2.	Recommended DC Operating Conditions	374
Table 18-3.	LDO Regulator Characteristics	375
Table 18-4.	Detailed Power Specifications	375
Table 18-5.	Flash Memory Characteristics	376
Table 18-6.	Phase Locked Loop (PLL) Characteristics	376
Table 18-7.	Clock Characteristics	377
Table 18-8.	ADC Characteristics	377
Table 18-9.	I ² C Characteristics	377
Table 18-10.	SSI Characteristics	378
Table 18-11.	JTAG Characteristics	380
Table 18-12.	GPIO Characteristics	382
Table 18-13.	Reset Characteristics	382
Table C-1.	Part Ordering Information	405

List of Registers

System Control	51
Register 1: Device Identification 0 (DID0), offset 0x000	60
Register 2: Power-On and Brown-Out Reset Control (PBORCTL), offset 0x030	62
Register 3: LDO Power Control (LDOPCTL), offset 0x034	63
Register 4: Raw Interrupt Status (RIS), offset 0x050	64
Register 5: Interrupt Mask Control (IMC), offset 0x054	65
Register 6: Masked Interrupt Status and Clear (MISC), offset 0x058	67
Register 7: Reset Cause (RESC), offset 0x05C	68
Register 8: Run-Mode Clock Configuration (RCC), offset 0x060	69
Register 9: XTAL to PLL Translation (PLLCFG), offset 0x064	73
Register 10: Deep Sleep Clock Configuration (DSLPCCLKCFG), offset 0x144	74
Register 11: Clock Verification Clear (CLKVCLR), offset 0x150	75
Register 12: Allow Unregulated LDO to Reset the Part (LDOARST), offset 0x160	76
Register 13: Device Identification 1 (DID1), offset 0x004	77
Register 14: Device Capabilities 0 (DC0), offset 0x008	79
Register 15: Device Capabilities 1 (DC1), offset 0x010	80
Register 16: Device Capabilities 2 (DC2), offset 0x014	82
Register 17: Device Capabilities 3 (DC3), offset 0x018	84
Register 18: Device Capabilities 4 (DC4), offset 0x01C	86
Register 19: Run Mode Clock Gating Control Register 0 (RCGC0), offset 0x100	87
Register 20: Sleep Mode Clock Gating Control Register 0 (SCGC0), offset 0x110	89
Register 21: Deep Sleep Mode Clock Gating Control Register 0 (DCGC0), offset 0x120	91
Register 22: Run Mode Clock Gating Control Register 1 (RCGC1), offset 0x104	93
Register 23: Sleep Mode Clock Gating Control Register 1 (SCGC1), offset 0x114	95
Register 24: Deep Sleep Mode Clock Gating Control Register 1 (DCGC1), offset 0x124	97
Register 25: Run Mode Clock Gating Control Register 2 (RCGC2), offset 0x108	99
Register 26: Sleep Mode Clock Gating Control Register 2 (SCGC2), offset 0x118	101
Register 27: Deep Sleep Mode Clock Gating Control Register 2 (DCGC2), offset 0x128	103
Register 28: Software Reset Control 0 (SRCR0), offset 0x040	105
Register 29: Software Reset Control 1 (SRCR1), offset 0x044	106
Register 30: Software Reset Control 2 (SRCR2), offset 0x048	107
Internal Memory	108
Register 1: Flash Memory Address (FMA), offset 0x000	114
Register 2: Flash Memory Data (FMD), offset 0x004	115
Register 3: Flash Memory Control (FMC), offset 0x008	116
Register 4: Flash Controller Raw Interrupt Status (FCRIS), offset 0x00C	118
Register 5: Flash Controller Interrupt Mask (FCIM), offset 0x010	119
Register 6: Flash Controller Masked Interrupt Status and Clear (FCMISC), offset 0x014	120
Register 7: USec Reload (USECRL), offset 0x140	121
Register 8: Flash Memory Protection Read Enable (FMPRE), offset 0x130	122
Register 9: Flash Memory Protection Program Enable (FMPPE), offset 0x134	123
General-Purpose Input/Outputs (GPIOs)	124
Register 1: GPIO Data (GPIODATA), offset 0x000	132
Register 2: GPIO Direction (GPIODIR), offset 0x400	133
Register 3: GPIO Interrupt Sense (GPIOIS), offset 0x404	134

Register 4:	GPIO Interrupt Both Edges (GPIOIBE), offset 0x408	135
Register 5:	GPIO Interrupt Event (GPIOIEV), offset 0x40C	136
Register 6:	GPIO Interrupt Mask (GPIOIM), offset 0x410	137
Register 7:	GPIO Raw Interrupt Status (GPIORIS), offset 0x414	138
Register 8:	GPIO Masked Interrupt Status (GPIOMIS), offset 0x418	139
Register 9:	GPIO Interrupt Clear (GPIOICR), offset 0x41C	140
Register 10:	GPIO Alternate Function Select (GPIOAFSEL), offset 0x420	141
Register 11:	GPIO 2-mA Drive Select (GPIODR2R), offset 0x500	143
Register 12:	GPIO 4-mA Drive Select (GPIODR4R), offset 0x504	144
Register 13:	GPIO 8-mA Drive Select (GPIODR8R), offset 0x508	145
Register 14:	GPIO Open Drain Select (GPIOODR), offset 0x50C	146
Register 15:	GPIO Pull-Up Select (GPIOPUR), offset 0x510	147
Register 16:	GPIO Pull-Down Select (GPIOPDR), offset 0x514	148
Register 17:	GPIO Slew Rate Control Select (GPIOSLR), offset 0x518	149
Register 18:	GPIO Digital Enable (GPIODEN), offset 0x51C	150
Register 19:	GPIO Peripheral Identification 4 (GPIOPeriphID4), offset 0xFD0	151
Register 20:	GPIO Peripheral Identification 5 (GPIOPeriphID5), offset 0xFD4	152
Register 21:	GPIO Peripheral Identification 6 (GPIOPeriphID6), offset 0xFD8	153
Register 22:	GPIO Peripheral Identification 7 (GPIOPeriphID7), offset 0xFDC	154
Register 23:	GPIO Peripheral Identification 0 (GPIOPeriphID0), offset 0xFE0	155
Register 24:	GPIO Peripheral Identification 1 (GPIOPeriphID1), offset 0xFE4	156
Register 25:	GPIO Peripheral Identification 2 (GPIOPeriphID2), offset 0xFE8	157
Register 26:	GPIO Peripheral Identification 3 (GPIOPeriphID3), offset 0xFEC	158
Register 27:	GPIO PrimeCell Identification 0 (GPIOPCellID0), offset 0xFF0	159
Register 28:	GPIO PrimeCell Identification 1 (GPIOPCellID1), offset 0xFF4	160
Register 29:	GPIO PrimeCell Identification 2 (GPIOPCellID2), offset 0xFF8	161
Register 30:	GPIO PrimeCell Identification 3 (GPIOPCellID3), offset 0xFFC	162
General-Purpose Timers		163
Register 1:	GPTM Configuration (GPTMCFG), offset 0x000	175
Register 2:	GPTM TimerA Mode (GPTMTAMR), offset 0x004	176
Register 3:	GPTM TimerB Mode (GPTMTBMR), offset 0x008	178
Register 4:	GPTM Control (GPTMCTL), offset 0x00C	180
Register 5:	GPTM Interrupt Mask (GPTMIMR), offset 0x018	183
Register 6:	GPTM Raw Interrupt Status (GPTMRIS), offset 0x01C	185
Register 7:	GPTM Masked Interrupt Status (GPTMMIS), offset 0x020	186
Register 8:	GPTM Interrupt Clear (GPTMICR), offset 0x024	187
Register 9:	GPTM TimerA Interval Load (GPTMTAILR), offset 0x028	189
Register 10:	GPTM TimerB Interval Load (GPTMTBILR), offset 0x02C	190
Register 11:	GPTM TimerA Match (GPTMTAMATCHR), offset 0x030	191
Register 12:	GPTM TimerB Match (GPTMTBMATCHR), offset 0x034	192
Register 13:	GPTM TimerA Prescale (GPTMTAPR), offset 0x038	193
Register 14:	GPTM TimerB Prescale (GPTMTBPR), offset 0x03C	194
Register 15:	GPTM TimerA Prescale Match (GPTMTAPMR), offset 0x040	195
Register 16:	GPTM TimerB Prescale Match (GPTMTBPMR), offset 0x044	196
Register 17:	GPTM TimerA (GPTMTAR), offset 0x048	197
Register 18:	GPTM TimerB (GPTMTBR), offset 0x04C	198
Watchdog Timer		199
Register 1:	Watchdog Load (WDTLOAD), offset 0x000	202

Register 2:	Watchdog Value (WDTVALUE), offset 0x004	203
Register 3:	Watchdog Control (WDTCTL), offset 0x008	204
Register 4:	Watchdog Interrupt Clear (WDTICR), offset 0x00C	205
Register 5:	Watchdog Raw Interrupt Status (WDTRIS), offset 0x010	206
Register 6:	Watchdog Masked Interrupt Status (WDTMIS), offset 0x014	207
Register 7:	Watchdog Test (WDTTEST), offset 0x418	208
Register 8:	Watchdog Lock (WDTLOCK), offset 0xC00	209
Register 9:	Watchdog Peripheral Identification 4 (WDTPeriphID4), offset 0xFD0	210
Register 10:	Watchdog Peripheral Identification 5 (WDTPeriphID5), offset 0xFD4	211
Register 11:	Watchdog Peripheral Identification 6 (WDTPeriphID6), offset 0xFD8	212
Register 12:	Watchdog Peripheral Identification 7 (WDTPeriphID7), offset 0xFDC	213
Register 13:	Watchdog Peripheral Identification 0 (WDTPeriphID0), offset 0xFE0	214
Register 14:	Watchdog Peripheral Identification 1 (WDTPeriphID1), offset 0xFE4	215
Register 15:	Watchdog Peripheral Identification 2 (WDTPeriphID2), offset 0xFE8	216
Register 16:	Watchdog Peripheral Identification 3 (WDTPeriphID3), offset 0xFEC	217
Register 17:	Watchdog PrimeCell Identification 0 (WDTPCellID0), offset 0xFF0	218
Register 18:	Watchdog PrimeCell Identification 1 (WDTPCellID1), offset 0xFF4	219
Register 19:	Watchdog PrimeCell Identification 2 (WDTPCellID2), offset 0xFF8	220
Register 20:	Watchdog PrimeCell Identification 3 (WDTPCellID3), offset 0xFFC	221
Analog-to-Digital Converter (ADC)		222
Register 1:	ADC Active Sample Sequencer (ADCACTSS), offset 0x000	230
Register 2:	ADC Raw Interrupt Status (ADCRIS), offset 0x004	231
Register 3:	ADC Interrupt Mask (ADCIM), offset 0x008	232
Register 4:	ADC Interrupt Status and Clear (ADCISC), offset 0x00C	233
Register 5:	ADC Overflow Status (ADCOSTAT), offset 0x010	234
Register 6:	ADC Event Multiplexer Select (ADCEMUX), offset 0x014	235
Register 7:	ADC Underflow Status (ADCUSTAT), offset 0x018	238
Register 8:	ADC Sample Sequencer Priority (ADCSSPRI), offset 0x020	239
Register 9:	ADC Processor Sample Sequence Initiate (ADCPSSI), offset 0x028	240
Register 10:	ADC Sample Averaging Control (ADCSAC), offset 0x030	241
Register 11:	ADC Sample Sequence Input Multiplexer Select 0 (ADCSSMUX0), offset 0x040	242
Register 12:	ADC Sample Sequence Control 0 (ADCSSCTL0), offset 0x044	244
Register 13:	ADC Sample Sequence Result FIFO 0 (ADCSSFIFO0), offset 0x048	247
Register 14:	ADC Sample Sequence Result FIFO 1 (ADCSSFIFO1), offset 0x068	247
Register 15:	ADC Sample Sequence Result FIFO 2 (ADCSSFIFO2), offset 0x088	247
Register 16:	ADC Sample Sequence Result FIFO 3 (ADCSSFIFO3), offset 0x0A8	247
Register 17:	ADC Sample Sequence FIFO 0 Status (ADCSSFSTAT0), offset 0x04C	248
Register 18:	ADC Sample Sequence FIFO 1 Status (ADCSSFSTAT1), offset 0x06C	248
Register 19:	ADC Sample Sequence FIFO 2 Status (ADCSSFSTAT2), offset 0x08C	248
Register 20:	ADC Sample Sequence FIFO 3 Status (ADCSSFSTAT3), offset 0x0AC	248
Register 21:	ADC Sample Sequence Input Multiplexer Select 1 (ADCSSMUX1), offset 0x060	249
Register 22:	ADC Sample Sequence Input Multiplexer Select 2 (ADCSSMUX2), offset 0x080	249
Register 23:	ADC Sample Sequence Control 1 (ADCSSCTL1), offset 0x064	250
Register 24:	ADC Sample Sequence Control 2 (ADCSSCTL2), offset 0x084	250
Register 25:	ADC Sample Sequence Input Multiplexer Select 3 (ADCSSMUX3), offset 0x0A0	252
Register 26:	ADC Sample Sequence Control 3 (ADCSSCTL3), offset 0x0A4	253
Register 27:	ADC Test Mode Loopback (ADCTMLB), offset 0x100	254

Universal Asynchronous Receivers/Transmitters (UARTs)	255
Register 1: UART Data (UARTDR), offset 0x000	262
Register 2: UART Receive Status/Error Clear (UARTSR/UARTECR), offset 0x004	264
Register 3: UART Flag (UARTFR), offset 0x018	266
Register 4: UART Integer Baud-Rate Divisor (UARTIBRD), offset 0x024	268
Register 5: UART Fractional Baud-Rate Divisor (UARTFBRD), offset 0x028	269
Register 6: UART Line Control (UARTLCRH), offset 0x02C	270
Register 7: UART Control (UARTCTL), offset 0x030	272
Register 8: UART Interrupt FIFO Level Select (UARTIFLS), offset 0x034	274
Register 9: UART Interrupt Mask (UARTIM), offset 0x038	276
Register 10: UART Raw Interrupt Status (UARTRIS), offset 0x03C	278
Register 11: UART Masked Interrupt Status (UARTMIS), offset 0x040	279
Register 12: UART Interrupt Clear (UARTICR), offset 0x044	280
Register 13: UART Peripheral Identification 4 (UARTPeriphID4), offset 0xFD0	282
Register 14: UART Peripheral Identification 5 (UARTPeriphID5), offset 0xFD4	283
Register 15: UART Peripheral Identification 6 (UARTPeriphID6), offset 0xFD8	284
Register 16: UART Peripheral Identification 7 (UARTPeriphID7), offset 0xFDC	285
Register 17: UART Peripheral Identification 0 (UARTPeriphID0), offset 0xFE0	286
Register 18: UART Peripheral Identification 1 (UARTPeriphID1), offset 0xFE4	287
Register 19: UART Peripheral Identification 2 (UARTPeriphID2), offset 0xFE8	288
Register 20: UART Peripheral Identification 3 (UARTPeriphID3), offset 0xFEC	289
Register 21: UART PrimeCell Identification 0 (UARTPCellID0), offset 0xFF0	290
Register 22: UART PrimeCell Identification 1 (UARTPCellID1), offset 0xFF4	291
Register 23: UART PrimeCell Identification 2 (UARTPCellID2), offset 0xFF8	292
Register 24: UART PrimeCell Identification 3 (UARTPCellID3), offset 0xFFC	293
Synchronous Serial Interface (SSI)	294
Register 1: SSI Control 0 (SSICR0), offset 0x000	306
Register 2: SSI Control 1 (SSICR1), offset 0x004	308
Register 3: SSI Data (SSIDR), offset 0x008	310
Register 4: SSI Status (SSISR), offset 0x00C	311
Register 5: SSI Clock Prescale (SSICPSR), offset 0x010	313
Register 6: SSI Interrupt Mask (SSIIM), offset 0x014	314
Register 7: SSI Raw Interrupt Status (SSIRIS), offset 0x018	316
Register 8: SSI Masked Interrupt Status (SSIMIS), offset 0x01C	317
Register 9: SSI Interrupt Clear (SSIICR), offset 0x020	318
Register 10: SSI Peripheral Identification 4 (SSIPeriphID4), offset 0xFD0	319
Register 11: SSI Peripheral Identification 5 (SSIPeriphID5), offset 0xFD4	320
Register 12: SSI Peripheral Identification 6 (SSIPeriphID6), offset 0xFD8	321
Register 13: SSI Peripheral Identification 7 (SSIPeriphID7), offset 0xFDC	322
Register 14: SSI Peripheral Identification 0 (SSIPeriphID0), offset 0xFE0	323
Register 15: SSI Peripheral Identification 1 (SSIPeriphID1), offset 0xFE4	324
Register 16: SSI Peripheral Identification 2 (SSIPeriphID2), offset 0xFE8	325
Register 17: SSI Peripheral Identification 3 (SSIPeriphID3), offset 0xFEC	326
Register 18: SSI PrimeCell Identification 0 (SSIPCellID0), offset 0xFF0	327
Register 19: SSI PrimeCell Identification 1 (SSIPCellID1), offset 0xFF4	328
Register 20: SSI PrimeCell Identification 2 (SSIPCellID2), offset 0xFF8	329
Register 21: SSI PrimeCell Identification 3 (SSIPCellID3), offset 0xFFC	330

Inter-Integrated Circuit (I²C) Interface	331
Register 1: I ² C Master Slave Address (I2CMSA), offset 0x000	345
Register 2: I ² C Master Control/Status (I2CMCS), offset 0x004	346
Register 3: I ² C Master Data (I2CMDR), offset 0x008	350
Register 4: I ² C Master Timer Period (I2CMTPR), offset 0x00C	351
Register 5: I ² C Master Interrupt Mask (I2CMIMR), offset 0x010	352
Register 6: I ² C Master Raw Interrupt Status (I2CMRIS), offset 0x014	353
Register 7: I ² C Master Masked Interrupt Status (I2CMMIS), offset 0x018	354
Register 8: I ² C Master Interrupt Clear (I2CMICR), offset 0x01C	355
Register 9: I ² C Master Configuration (I2CMCR), offset 0x020	356
Register 10: I ² C Slave Own Address (I2CSOAR), offset 0x000	358
Register 11: I ² C Slave Control/Status (I2CSCSR), offset 0x004	359
Register 12: I ² C Slave Data (I2CSDR), offset 0x008	361
Register 13: I ² C Slave Interrupt Mask (I2CSIMR), offset 0x00C	362
Register 14: I ² C Slave Raw Interrupt Status (I2CSRIS), offset 0x010	363
Register 15: I ² C Slave Masked Interrupt Status (I2CSMIS), offset 0x014	364
Register 16: I ² C Slave Interrupt Clear (I2CSICR), offset 0x018	365

About This Document

This data sheet provides reference information for the LM3S828 microcontroller, describing the functional blocks of the system-on-chip (SoC) device designed around the ARM® Cortex™-M3 core.

Audience

This manual is intended for system software developers, hardware designers, and application developers.

About This Manual

This document is organized into sections that correspond to each major feature.

Related Documents

The following documents are referenced by the data sheet, and available on the documentation CD or from the Luminary Micro web site at www.luminarymicro.com:

- *ARM® Cortex™-M3 Technical Reference Manual*
- *ARM® CoreSight Technical Reference Manual*
- *ARM® v7-M Architecture Application Level Reference Manual*
- *Stellaris® Peripheral Driver Library User's Guide*
- *Stellaris® ROM User's Guide*

The following related documents are also referenced:

- *IEEE Standard 1149.1-Test Access Port and Boundary-Scan Architecture*

This documentation list was current as of publication date. Please check the Luminary Micro web site for additional documentation, including application notes and white papers.

Documentation Conventions

This document uses the conventions shown in Table 1 on page 16.

Table 1. Documentation Conventions

Notation	Meaning
General Register Notation	
REGISTER	APB registers are indicated in uppercase bold. For example, PBORCTL is the Power-On and Brown-Out Reset Control register. If a register name contains a lowercase n, it represents more than one register. For example, SRCRn represents any (or all) of the three Software Reset Control registers: SRCR0 , SRCR1 , and SRCR2 .
bit	A single bit in a register.
bit field	Two or more consecutive and related bits.
offset 0xnnn	A hexadecimal increment to a register's address, relative to that module's base address as specified in "Memory Map" on page 37.

Notation	Meaning
Register <i>N</i>	Registers are numbered consecutively throughout the document to aid in referencing them. The register number has no meaning to software.
reserved	Register bits marked <i>reserved</i> are reserved for future use. In most cases, reserved bits are set to 0; however, user software should not rely on the value of a reserved bit. To provide software compatibility with future products, the value of a reserved bit should be preserved across a read-modify-write operation.
yy:xx	The range of register bits inclusive from xx to yy. For example, 31:15 means bits 15 through 31 in that register.
Register Bit/Field Types	This value in the register bit diagram indicates whether software running on the controller can change the value of the bit field.
RC	Software can read this field. The bit or field is cleared by hardware after reading the bit/field.
RO	Software can read this field. Always write the chip reset value.
R/W	Software can read or write this field.
R/W1C	Software can read or write this field. A write of a 0 to a W1C bit does not affect the bit value in the register. A write of a 1 clears the value of the bit in the register; the remaining bits remain unchanged. This register type is primarily used for clearing interrupt status bits where the read operation provides the interrupt status and the write of the read value clears only the interrupts being reported at the time the register was read.
R/W1S	Software can read or write a 1 to this field. A write of a 0 to a R/W1S bit does not affect the bit value in the register.
W1C	Software can write this field. A write of a 0 to a W1C bit does not affect the bit value in the register. A write of a 1 clears the value of the bit in the register; the remaining bits remain unchanged. A read of the register returns no meaningful data. This register is typically used to clear the corresponding bit in an interrupt register.
WO	Only a write by software is valid; a read of the register returns no meaningful data.
Register Bit/Field Reset Value	This value in the register bit diagram shows the bit/field value after any reset, unless noted.
0	Bit cleared to 0 on chip reset.
1	Bit set to 1 on chip reset.
-	Nondeterministic.
Pin/Signal Notation	
[]	Pin alternate function; a pin defaults to the signal without the brackets.
pin	Refers to the physical connection on the package.
signal	Refers to the electrical signal encoding of a pin.
assert a signal	Change the value of the signal from the logically False state to the logically True state. For active High signals, the asserted signal value is 1 (High); for active Low signals, the asserted signal value is 0 (Low). The active polarity (High or Low) is defined by the signal name (see <code>SIGNAL</code> and <code>̄SIGNAL</code> below).
deassert a signal	Change the value of the signal from the logically True state to the logically False state.
<code>̄SIGNAL</code>	Signal names are in uppercase and in the Courier font. An overbar on a signal name indicates that it is active Low. To assert <code>̄SIGNAL</code> is to drive it Low; to deassert <code>̄SIGNAL</code> is to drive it High.
<code>SIGNAL</code>	Signal names are in uppercase and in the Courier font. An active High signal has no overbar. To assert <code>SIGNAL</code> is to drive it High; to deassert <code>SIGNAL</code> is to drive it Low.
Numbers	
X	An uppercase X indicates any of several values is allowed, where X can be any legal pattern. For example, a binary value of 0X00 can be either 0100 or 0000, a hex value of 0xX is 0x0 or 0x1, and so on.

Notation	Meaning
0x	Hexadecimal numbers have a prefix of 0x. For example, 0x00FF is the hexadecimal number FF. All other numbers within register tables are assumed to be binary. Within conceptual information, binary numbers are indicated with a b suffix, for example, 1011b, and decimal numbers are written without a prefix or suffix.

1 Architectural Overview

The Luminary Micro Stellaris® family of microcontrollers—the first ARM® Cortex™-M3 based controllers—brings high-performance 32-bit computing to cost-sensitive embedded microcontroller applications. These pioneering parts deliver customers 32-bit performance at a cost equivalent to legacy 8- and 16-bit devices, all in a package with a small footprint.

The LM3S828 microcontroller is targeted for industrial applications, including test and measurement equipment, factory automation, HVAC and building control, motion control, medical instrumentation, fire and security, and power/energy.

In addition, the LM3S828 microcontroller offers the advantages of ARM's widely available development tools, System-on-Chip (SoC) infrastructure IP applications, and a large user community. Additionally, the microcontroller uses ARM's Thumb®-compatible Thumb-2 instruction set to reduce memory requirements and, thereby, cost. Finally, the LM3S828 microcontroller is code-compatible to all members of the extensive Stellaris® family; providing flexibility to fit our customers' precise needs.

Luminary Micro offers a complete solution to get to market quickly, with evaluation and development boards, white papers and application notes, an easy-to-use peripheral driver library, and a strong support, sales, and distributor network. See “Ordering and Contact Information” on page 405 for ordering information for Stellaris® family devices.

1.1 Product Features

The LM3S828 microcontroller includes the following product features:

- 32-Bit RISC Performance
 - 32-bit ARM® Cortex™-M3 v7M architecture optimized for small-footprint embedded applications
 - System timer (SysTick), providing a simple, 24-bit clear-on-write, decrementing, wrap-on-zero counter with a flexible control mechanism
 - Thumb®-compatible Thumb-2-only instruction set processor core for high code density
 - 50-MHz operation
 - Hardware-division and single-cycle-multiplication
 - Integrated Nested Vectored Interrupt Controller (NVIC) providing deterministic interrupt handling
 - 22 interrupts with eight priority levels
 - Memory protection unit (MPU), providing a privileged mode for protected operating system functionality
 - Unaligned data access, enabling data to be efficiently packed into memory
 - Atomic bit manipulation (bit-banding), delivering maximum memory utilization and streamlined peripheral control
- Internal Memory

- 64 KB single-cycle flash
 - User-managed flash block protection on a 2-KB block basis
 - User-managed flash data programming
 - User-defined and managed flash-protection block
- 8 KB single-cycle SRAM
- General-Purpose Timers
 - Three General-Purpose Timer Modules (GPTM), each of which provides two 16-bit timers. Each GPTM can be configured to operate independently:
 - As a single 32-bit timer
 - As one 32-bit Real-Time Clock (RTC) to event capture
 - For Pulse Width Modulation (PWM)
 - To trigger analog-to-digital conversions
 - 32-bit Timer modes
 - Programmable one-shot timer
 - Programmable periodic timer
 - Real-Time Clock when using an external 32.768-KHz clock as the input
 - User-enabled stalling in periodic and one-shot mode when the controller asserts the CPU Halt flag during debug
 - ADC event trigger
 - 16-bit Timer modes
 - General-purpose timer function with an 8-bit prescaler
 - Programmable one-shot timer
 - Programmable periodic timer
 - User-enabled stalling when the controller asserts CPU Halt flag during debug
 - ADC event trigger
 - 16-bit Input Capture modes
 - Input edge count capture
 - Input edge time capture
 - 16-bit PWM mode
 - Simple PWM mode with software-programmable output inversion of the PWM signal

- ARM FiRM-compliant Watchdog Timer
 - 32-bit down counter with a programmable load register
 - Separate watchdog clock with an enable
 - Programmable interrupt generation logic with interrupt masking
 - Lock register protection from runaway software
 - Reset generation logic with an enable/disable
 - User-enabled stalling when the controller asserts the CPU Halt flag during debug
- Synchronous Serial Interface (SSI)
 - Master or slave operation
 - Programmable clock bit rate and prescale
 - Separate transmit and receive FIFOs, 16 bits wide, 8 locations deep
 - Programmable interface operation for Freescale SPI, MICROWIRE, or Texas Instruments synchronous serial interfaces
 - Programmable data frame size from 4 to 16 bits
 - Internal loopback test mode for diagnostic/debug testing
- UART
 - Two fully programmable 16C550-type UARTs
 - Separate 16x8 transmit (TX) and 16x12 receive (RX) FIFOs to reduce CPU interrupt service loading
 - Programmable baud-rate generator allowing speeds up to 3.125 Mbps
 - Programmable FIFO length, including 1-byte deep operation providing conventional double-buffered interface
 - FIFO trigger levels of 1/8, 1/4, 1/2, 3/4, and 7/8
 - Standard asynchronous communication bits for start, stop, and parity
 - False-start-bit detection
 - Line-break generation and detection
- ADC
 - Single- and differential-input configurations
 - Eight 10-bit channels (inputs) when used as single-ended inputs
 - Sample rate of one million samples/second

- Flexible, configurable analog-to-digital conversion
- Four programmable sample conversion sequences from one to eight entries long, with corresponding conversion result FIFOs
- Each sequence triggered by software or internal event (timers, or GPIO)
- On-chip temperature sensor
- I²C
 - Master and slave receive and transmit operation with transmission speed up to 100 Kbps in Standard mode and 400 Kbps in Fast mode
 - Interrupt generation
 - Master with arbitration and clock synchronization, multimaster support, and 7-bit addressing mode
- GPIOs
 - 7-28 GPIOs, depending on configuration
 - 5-V-tolerant input/outputs
 - Programmable interrupt generation as either edge-triggered or level-sensitive
 - Low interrupt latency; as low as 6 cycles and never more than 12 cycles
 - Bit masking in both read and write operations through address lines
 - Can initiate an ADC sample sequence
 - Pins configured as digital inputs are Schmitt-triggered.
 - Programmable control for GPIO pad configuration:
 - Weak pull-up or pull-down resistors
 - 2-mA, 4-mA, and 8-mA pad drive for digital communication
 - Slew rate control for the 8-mA drive
 - Open drain enables
 - Digital input enables
- Power
 - On-chip Low Drop-Out (LDO) voltage regulator, with programmable output user-adjustable from 2.25 V to 2.75 V
 - Low-power options on controller: Sleep and Deep-sleep modes
 - Low-power options for peripherals: software controls shutdown of individual peripherals
 - User-enabled LDO unregulated voltage detection and automatic reset

- 3.3-V supply brown-out detection and reporting via interrupt or reset
- Flexible Reset Sources
 - Power-on reset (POR)
 - Reset pin assertion
 - Brown-out (BOR) detector alerts to system power drops
 - Software reset
 - Watchdog timer reset
 - Internal low drop-out (LDO) regulator output goes unregulated
- Additional Features
 - Six reset sources
 - Programmable clock source control
 - Clock gating to individual peripherals for power savings
 - IEEE 1149.1-1990 compliant Test Access Port (TAP) controller
 - Debug access via JTAG and Serial Wire interfaces
 - Full JTAG boundary scan
- Industrial and extended temperature 48-pin RoHS-compliant LQFP package

1.2 Target Applications

- Factory automation and control
- Industrial control power devices
- Building and home automation
- Stepper motors
- Brushless DC motors
- AC induction motors

1.3 High-Level Block Diagram

Figure 1-1 on page 24 represents the full set of features in the Stellaris[®] 800 series of devices; not all features may be available on the LM3S828 microcontroller.

Figure 1-1. Stellaris® 800 Series High-Level Block Diagram

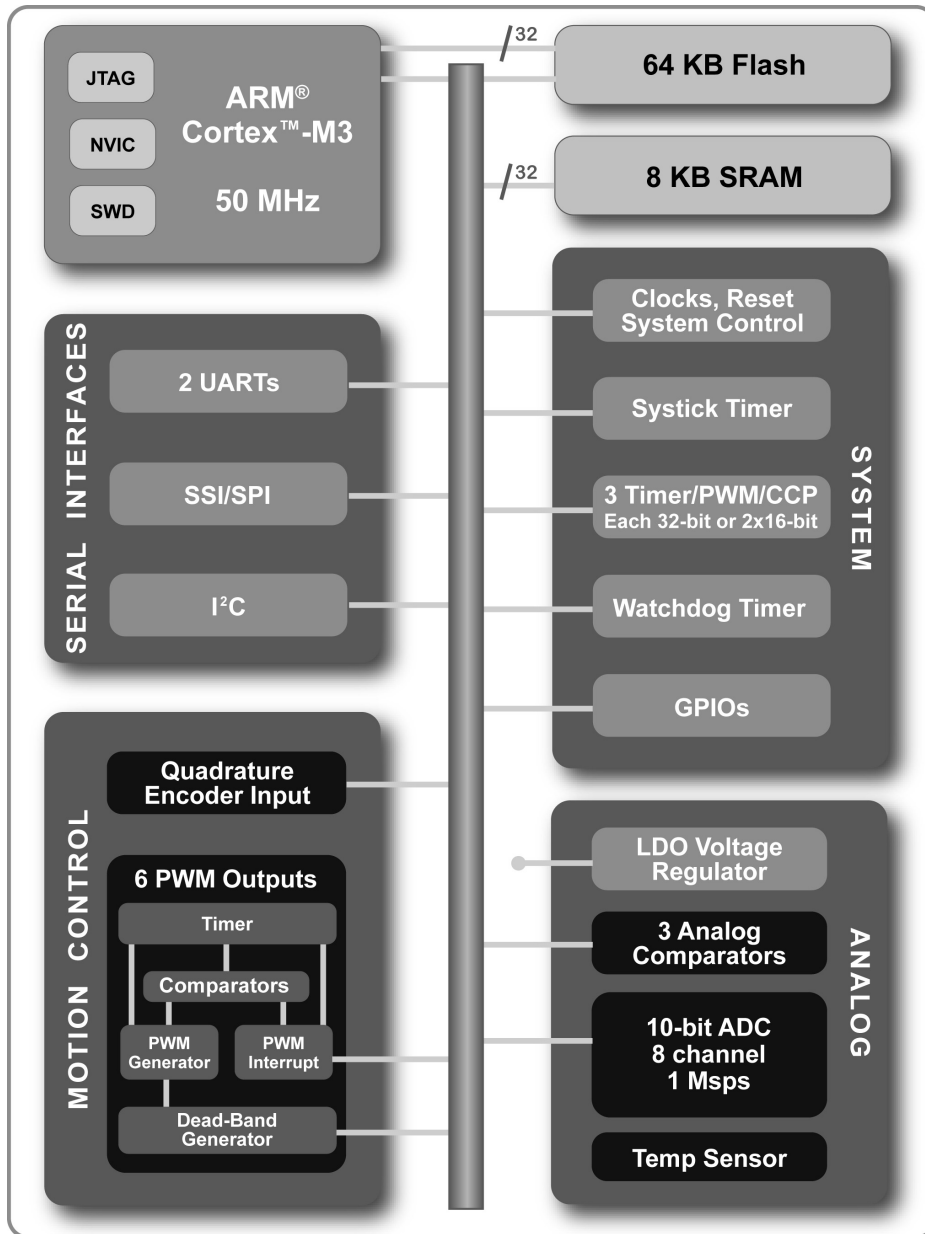

1.4 Functional Overview

The following sections provide an overview of the features of the LM3S828 microcontroller. The page number in parenthesis indicates where that feature is discussed in detail. Ordering and support information can be found in “Ordering and Contact Information” on page 405.

1.4.1 ARM Cortex™-M3

1.4.1.1 Processor Core (see page 31)

All members of the Stellaris® product family, including the LM3S828 microcontroller, are designed around an ARM Cortex™-M3 processor core. The ARM Cortex-M3 processor provides the core for a high-performance, low-cost platform that meets the needs of minimal memory implementation, reduced pin count, and low-power consumption, while delivering outstanding computational performance and exceptional system response to interrupts.

“ARM Cortex-M3 Processor Core” on page 31 provides an overview of the ARM core; the core is detailed in the *ARM® Cortex™-M3 Technical Reference Manual*.

1.4.1.2 System Timer (SysTick)

Cortex-M3 includes an integrated system timer, SysTick. SysTick provides a simple, 24-bit clear-on-write, decrementing, wrap-on-zero counter with a flexible control mechanism. The counter can be used in several different ways, for example:

- An RTOS tick timer which fires at a programmable rate (for example, 100 Hz) and invokes a SysTick routine.
- A high-speed alarm timer using the system clock.
- A variable rate alarm or signal timer—the duration is range-dependent on the reference clock used and the dynamic range of the counter.
- A simple counter. Software can use this to measure time to completion and time used.
- An internal clock source control based on missing/meeting durations. The COUNTFLAG bit-field in the control and status register can be used to determine if an action completed within a set duration, as part of a dynamic clock management control loop.

1.4.1.3 Nested Vectored Interrupt Controller (NVIC)

The LM3S828 controller includes the ARM Nested Vectored Interrupt Controller (NVIC) on the ARM® Cortex™-M3 core. The NVIC and Cortex-M3 prioritize and handle all exceptions. All exceptions are handled in Handler Mode. The processor state is automatically stored to the stack on an exception, and automatically restored from the stack at the end of the Interrupt Service Routine (ISR). The vector is fetched in parallel to the state saving, which enables efficient interrupt entry. The processor supports tail-chaining, which enables back-to-back interrupts to be performed without the overhead of state saving and restoration. Software can set eight priority levels on 7 exceptions (system handlers) and 22 interrupts.

“Interrupts” on page 39 provides an overview of the NVIC controller and the interrupt map. Exceptions and interrupts are detailed in the *ARM® Cortex™-M3 Technical Reference Manual*.

1.4.2 Motor Control Peripherals

To enhance motor control, the LM3S828 controller features Pulse Width Modulation (PWM) outputs.

1.4.2.1 PWM

Pulse width modulation (PWM) is a powerful technique for digitally encoding analog signal levels. High-resolution counters are used to generate a square wave, and the duty cycle of the square wave is modulated to encode an analog signal. Typical applications include switching power supplies and motor control.

On the LM3S828, PWM motion control functionality can be achieved through:

- The motion control features of the general-purpose timers using the CCP pins

CCP Pins (see page 169)

The General-Purpose Timer Module's CCP (Capture Compare PWM) pins are software programmable to support a simple PWM mode with a software-programmable output inversion of the PWM signal.

1.4.3 Analog Peripherals

To handle analog signals, the LM3S828 microcontroller offers an Analog-to-Digital Converter (ADC).

1.4.3.1 ADC (see page 222)

An analog-to-digital converter (ADC) is a peripheral that converts a continuous analog voltage to a discrete digital number.

The LM3S828 ADC module features 10-bit conversion resolution and supports eight input channels, plus an internal temperature sensor. Four buffered sample sequences allow rapid sampling of up to eight analog input sources without controller intervention. Each sample sequence provides flexible programming with fully configurable input source, trigger events, interrupt generation, and sequence priority.

1.4.4 Serial Communications Peripherals

The LM3S828 controller supports both asynchronous and synchronous serial communications with:

- Two fully programmable 16C550-type UARTs
- One SSI module
- One I²C module

1.4.4.1 UART (see page 255)

A Universal Asynchronous Receiver/Transmitter (UART) is an integrated circuit used for RS-232C serial communications, containing a transmitter (parallel-to-serial converter) and a receiver (serial-to-parallel converter), each clocked separately.

The LM3S828 controller includes two fully programmable 16C550-type UARTs that support data transfer speeds up to 3.125 Mbps. (Although similar in functionality to a 16C550 UART, it is not register-compatible.)

Separate 16x8 transmit (TX) and 16x12 receive (RX) FIFOs reduce CPU interrupt service loading. The UART can generate individually masked interrupts from the RX, TX, modem status, and error conditions. The module provides a single combined interrupt when any of the interrupts are asserted and are unmasked.

1.4.4.2 SSI (see page 294)

Synchronous Serial Interface (SSI) is a four-wire bi-directional communications interface.

The LM3S828 controller includes one SSI module that provides the functionality for synchronous serial communications with peripheral devices, and can be configured to use the Freescale SPI, MICROWIRE, or TI synchronous serial interface frame formats. The size of the data frame is also configurable, and can be set between 4 and 16 bits, inclusive.

The SSI module performs serial-to-parallel conversion on data received from a peripheral device, and parallel-to-serial conversion on data transmitted to a peripheral device. The TX and RX paths are buffered with internal FIFOs, allowing up to eight 16-bit values to be stored independently.

The SSI module can be configured as either a master or slave device. As a slave device, the SSI module can also be configured to disable its output, which allows a master device to be coupled with multiple slave devices.

The SSI module also includes a programmable bit rate clock divider and prescaler to generate the output serial clock derived from the SSI module's input clock. Bit rates are generated based on the input clock and the maximum bit rate is determined by the connected peripheral.

1.4.4.3 I²C (see page 331)

The Inter-Integrated Circuit (I²C) bus provides bi-directional data transfer through a two-wire design (a serial data line SDA and a serial clock line SCL).

The I²C bus interfaces to external I²C devices such as serial memory (RAMs and ROMs), networking devices, LCDs, tone generators, and so on. The I²C bus may also be used for system testing and diagnostic purposes in product development and manufacture.

The LM3S828 controller includes one I²C module that provides the ability to communicate to other IC devices over an I²C bus. The I²C bus supports devices that can both transmit and receive (write and read) data.

Devices on the I²C bus can be designated as either a master or a slave. The I²C module supports both sending and receiving data as either a master or a slave, and also supports the simultaneous operation as both a master and a slave. The four I²C modes are: Master Transmit, Master Receive, Slave Transmit, and Slave Receive.

A Stellaris[®] I²C module can operate at two speeds: Standard (100 Kbps) and Fast (400 Kbps).

Both the I²C master and slave can generate interrupts. The I²C master generates interrupts when a transmit or receive operation completes (or aborts due to an error). The I²C slave generates interrupts when data has been sent or requested by a master.

1.4.5 System Peripherals

1.4.5.1 Programmable GPIOs (see page 124)

General-purpose input/output (GPIO) pins offer flexibility for a variety of connections.

The Stellaris[®] GPIO module is comprised of five physical GPIO blocks, each corresponding to an individual GPIO port. The GPIO module is FiRM-compliant (compliant to the ARM Foundation IP for Real-Time Microcontrollers specification) and supports 7-28 programmable input/output pins. The number of GPIOs available depends on the peripherals being used (see "Signal Tables" on page 367 for the signals available to each GPIO pin).

The GPIO module features programmable interrupt generation as either edge-triggered or level-sensitive on all pins, programmable control for GPIO pad configuration, and bit masking in both read and write operations through address lines. Pins configured as digital inputs are Schmitt-triggered.

1.4.5.2 Three Programmable Timers (see page 163)

Programmable timers can be used to count or time external events that drive the Timer input pins.

The Stellaris[®] General-Purpose Timer Module (GPTM) contains three GPTM blocks. Each GPTM block provides two 16-bit timers/counters that can be configured to operate independently as timers

or event counters, or configured to operate as one 32-bit timer or one 32-bit Real-Time Clock (RTC). Timers can also be used to trigger analog-to-digital (ADC) conversions.

When configured in 32-bit mode, a timer can run as a Real-Time Clock (RTC), one-shot timer or periodic timer. When in 16-bit mode, a timer can run as a one-shot timer or periodic timer, and can extend its precision by using an 8-bit prescaler. A 16-bit timer can also be configured for event capture or Pulse Width Modulation (PWM) generation.

1.4.5.3 Watchdog Timer (see page 199)

A watchdog timer can generate nonmaskable interrupts (NMIs) or a reset when a time-out value is reached. The watchdog timer is used to regain control when a system has failed due to a software error or to the failure of an external device to respond in the expected way.

The Stellaris[®] Watchdog Timer module consists of a 32-bit down counter, a programmable load register, interrupt generation logic, and a locking register.

The Watchdog Timer can be configured to generate an interrupt to the controller on its first time-out, and to generate a reset signal on its second time-out. Once the Watchdog Timer has been configured, the lock register can be written to prevent the timer configuration from being inadvertently altered.

1.4.6 Memory Peripherals

The LM3S828 controller offers both single-cycle SRAM and single-cycle Flash memory.

1.4.6.1 SRAM (see page 108)

The LM3S828 static random access memory (SRAM) controller supports 8 KB SRAM. The internal SRAM of the Stellaris[®] devices is located at offset 0x0000.0000 of the device memory map. To reduce the number of time-consuming read-modify-write (RMW) operations, ARM has introduced *bit-banding* technology in the new Cortex-M3 processor. With a bit-band-enabled processor, certain regions in the memory map (SRAM and peripheral space) can use address aliases to access individual bits in a single, atomic operation.

1.4.6.2 Flash (see page 109)

The LM3S828 Flash controller supports 64 KB of flash memory. The flash is organized as a set of 1-KB blocks that can be individually erased. Erasing a block causes the entire contents of the block to be reset to all 1s. These blocks are paired into a set of 2-KB blocks that can be individually protected. The blocks can be marked as read-only or execute-only, providing different levels of code protection. Read-only blocks cannot be erased or programmed, protecting the contents of those blocks from being modified. Execute-only blocks cannot be erased or programmed, and can only be read by the controller instruction fetch mechanism, protecting the contents of those blocks from being read by either the controller or by a debugger.

1.4.7 Additional Features

1.4.7.1 Memory Map (see page 37)

A memory map lists the location of instructions and data in memory. The memory map for the LM3S828 controller can be found in “Memory Map” on page 37. Register addresses are given as a hexadecimal increment, relative to the module’s base address as shown in the memory map.

The *ARM[®] Cortex[™]-M3 Technical Reference Manual* provides further information on the memory map.

1.4.7.2 JTAG TAP Controller (see page 41)

The Joint Test Action Group (JTAG) port is an IEEE standard that defines a Test Access Port and Boundary Scan Architecture for digital integrated circuits and provides a standardized serial interface for controlling the associated test logic. The TAP, Instruction Register (IR), and Data Registers (DR) can be used to test the interconnections of assembled printed circuit boards and obtain manufacturing information on the components. The JTAG Port also provides a means of accessing and controlling design-for-test features such as I/O pin observation and control, scan testing, and debugging.

The JTAG port is composed of the standard five pins: $\overline{\text{TRST}}$, TCK, TMS, TDI, and TDO. Data is transmitted serially into the controller on TDI and out of the controller on TDO. The interpretation of this data is dependent on the current state of the TAP controller. For detailed information on the operation of the JTAG port and TAP controller, please refer to the *IEEE Standard 1149.1-Test Access Port and Boundary-Scan Architecture*.

The Luminary Micro JTAG controller works with the ARM JTAG controller built into the Cortex-M3 core. This is implemented by multiplexing the TDO outputs from both JTAG controllers. ARM JTAG instructions select the ARM TDO output while Luminary Micro JTAG instructions select the Luminary Micro TDO outputs. The multiplexer is controlled by the Luminary Micro JTAG controller, which has comprehensive programming for the ARM, Luminary Micro, and unimplemented JTAG instructions.

1.4.7.3 System Control and Clocks (see page 51)

System control determines the overall operation of the device. It provides information about the device, controls the clocking of the device and individual peripherals, and handles reset detection and reporting.

1.4.8 Hardware Details

Details on the pins and package can be found in the following sections:

- “Pin Diagram” on page 366
- “Signal Tables” on page 367
- “Operating Characteristics” on page 373
- “Electrical Characteristics” on page 374
- “Package Information” on page 385

1.4.9 System Block Diagram

Figure 1-2. LM3S828 Controller System-Level Block Diagram

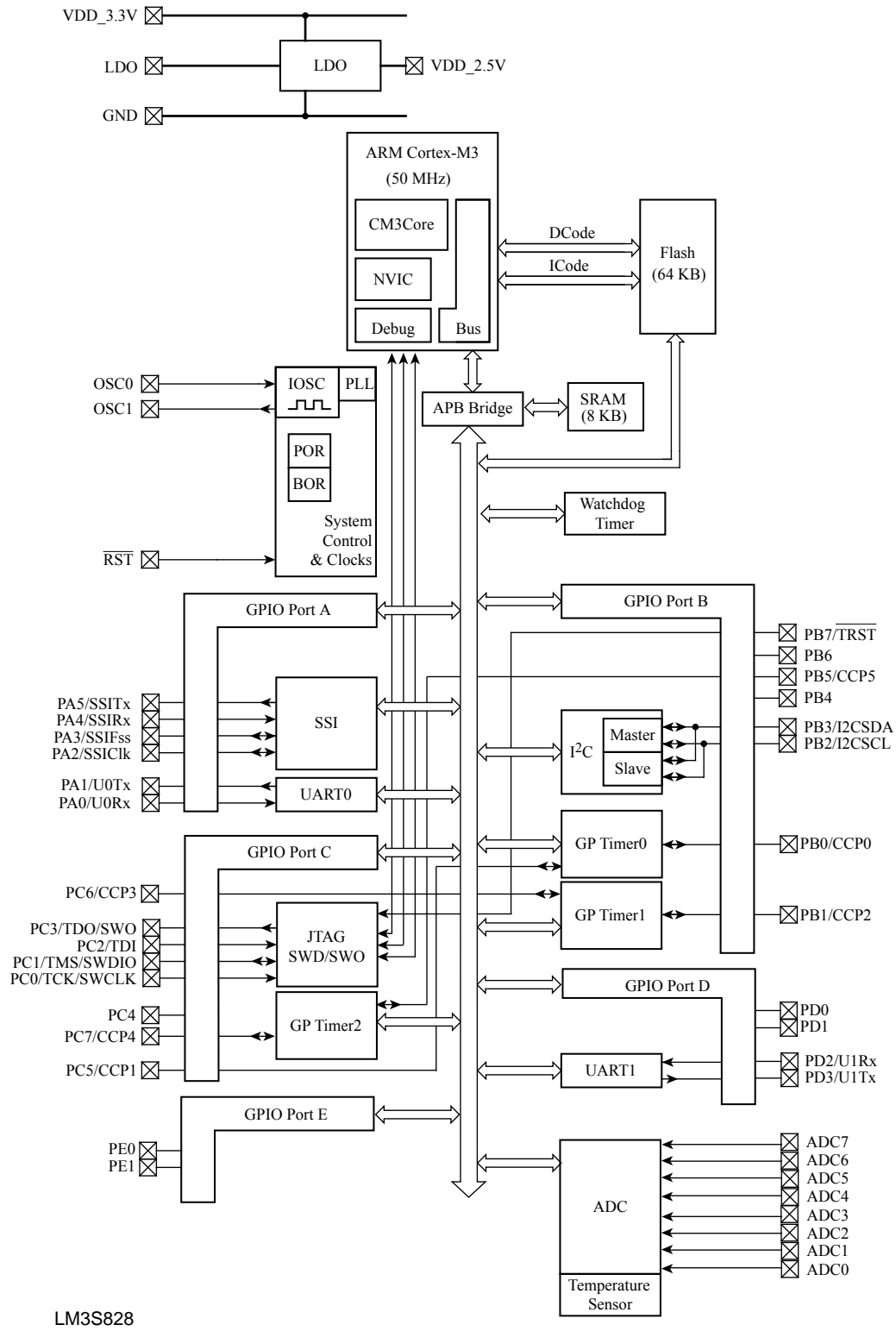

2 ARM Cortex-M3 Processor Core

The ARM Cortex-M3 processor provides the core for a high-performance, low-cost platform that meets the needs of minimal memory implementation, reduced pin count, and low power consumption, while delivering outstanding computational performance and exceptional system response to interrupts. Features include:

- Compact core.
- Thumb-2 instruction set, delivering the high-performance expected of an ARM core in the memory size usually associated with 8- and 16-bit devices; typically in the range of a few kilobytes of memory for microcontroller class applications.
- Rapid application execution through Harvard architecture characterized by separate buses for instruction and data.
- Exceptional interrupt handling, by implementing the register manipulations required for handling an interrupt in hardware.
- Deterministic, fast interrupt processing: always 12 cycles, or just 6 cycles with tail-chaining
- Memory protection unit (MPU) to provide a privileged mode of operation for complex applications.
- Migration from the ARM7™ processor family for better performance and power efficiency.
- Full-featured debug solution with a:
 - Serial Wire JTAG Debug Port (SWJ-DP)
 - Flash Patch and Breakpoint (FPB) unit for implementing breakpoints
 - Data Watchpoint and Trigger (DWT) unit for implementing watchpoints, trigger resources, and system profiling
 - Instrumentation Trace Macrocell (ITM) for support of printf style debugging
 - Trace Port Interface Unit (TPIU) for bridging to a Trace Port Analyzer
- Optimized for single-cycle flash usage
- Three sleep modes with clock gating for low power
- Single-cycle multiply instruction and hardware divide
- Atomic operations
- ARM Thumb2 mixed 16-/32-bit instruction set
- 1.25 DMIPS/MHz

The Stellaris® family of microcontrollers builds on this core to bring high-performance 32-bit computing to cost-sensitive embedded microcontroller applications, such as factory automation and control, industrial control power devices, building and home automation, and stepper motors.

For more information on the ARM Cortex-M3 processor core, see the *ARM® Cortex™-M3 Technical Reference Manual*. For information on SWJ-DP, see the *ARM® CoreSight Technical Reference Manual*.

2.1 Block Diagram

Figure 2-1. CPU Block Diagram

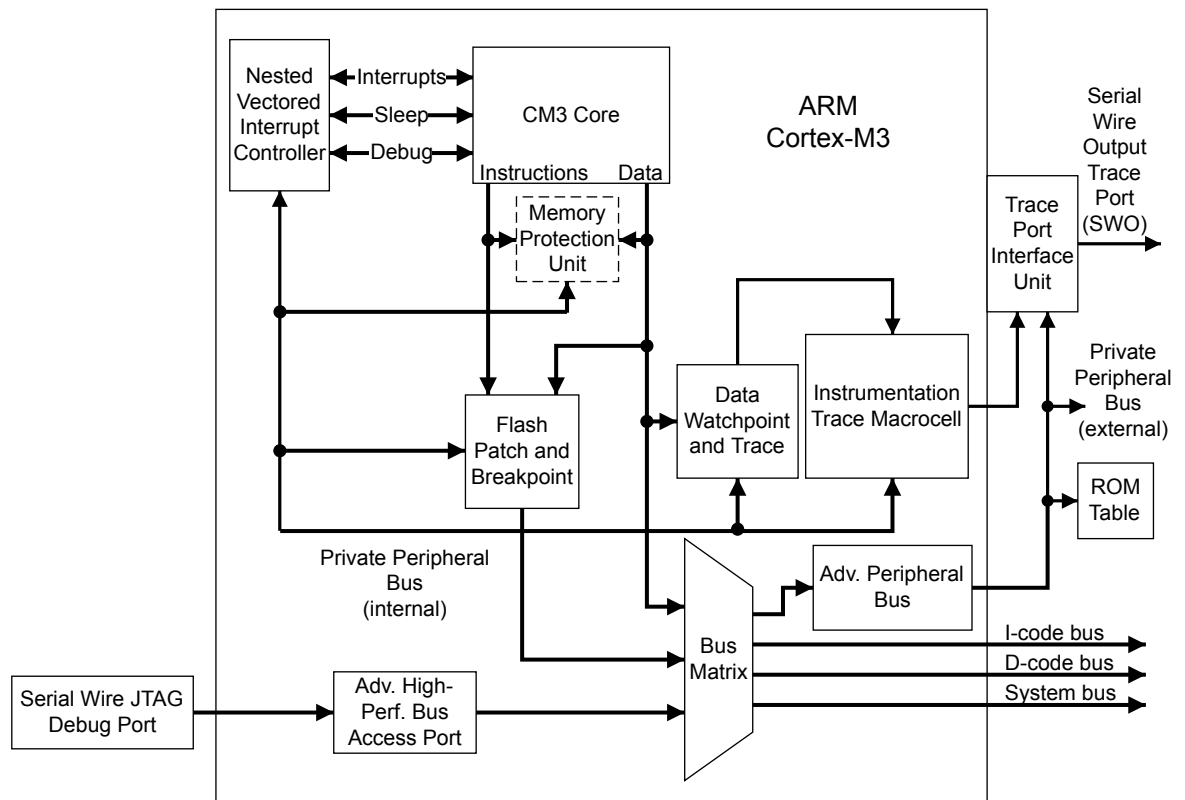

2.2 Functional Description

Important: The *ARM® Cortex™-M3 Technical Reference Manual* describes all the features of an ARM Cortex-M3 in detail. However, these features differ based on the implementation. This section describes the Stellaris® implementation.

Luminary Micro has implemented the ARM Cortex-M3 core as shown in Figure 2-1 on page 32. As noted in the *ARM® Cortex™-M3 Technical Reference Manual*, several Cortex-M3 components are flexible in their implementation: SW/JTAG-DP, ETM, TPIU, the ROM table, the MPU, and the Nested Vectored Interrupt Controller (NVIC). Each of these is addressed in the sections that follow.

2.2.1 Serial Wire and JTAG Debug

Luminary Micro has replaced the ARM SW-DP and JTAG-DP with the ARM CoreSight™-compliant Serial Wire JTAG Debug Port (SWJ-DP) interface. This means Chapter 12, “Debug Port,” of the *ARM® Cortex™-M3 Technical Reference Manual* does not apply to Stellaris® devices.

The SWJ-DP interface combines the SWD and JTAG debug ports into one module. See the *CoreSight™ Design Kit Technical Reference Manual* for details on SWJ-DP.

2.2.2 Embedded Trace Macrocell (ETM)

ETM was not implemented in the Stellaris® devices. This means Chapters 15 and 16 of the *ARM® Cortex™-M3 Technical Reference Manual* can be ignored.

2.2.3 Trace Port Interface Unit (TPIU)

The TPIU acts as a bridge between the Cortex-M3 trace data from the ITM, and an off-chip Trace Port Analyzer. The Stellaris® devices have implemented TPIU as shown in Figure 2-2 on page 33. This is similar to the non-ETM version described in the *ARM® Cortex™-M3 Technical Reference Manual*, however, SWJ-DP only provides SWV output for the TPIU.

Figure 2-2. TPIU Block Diagram

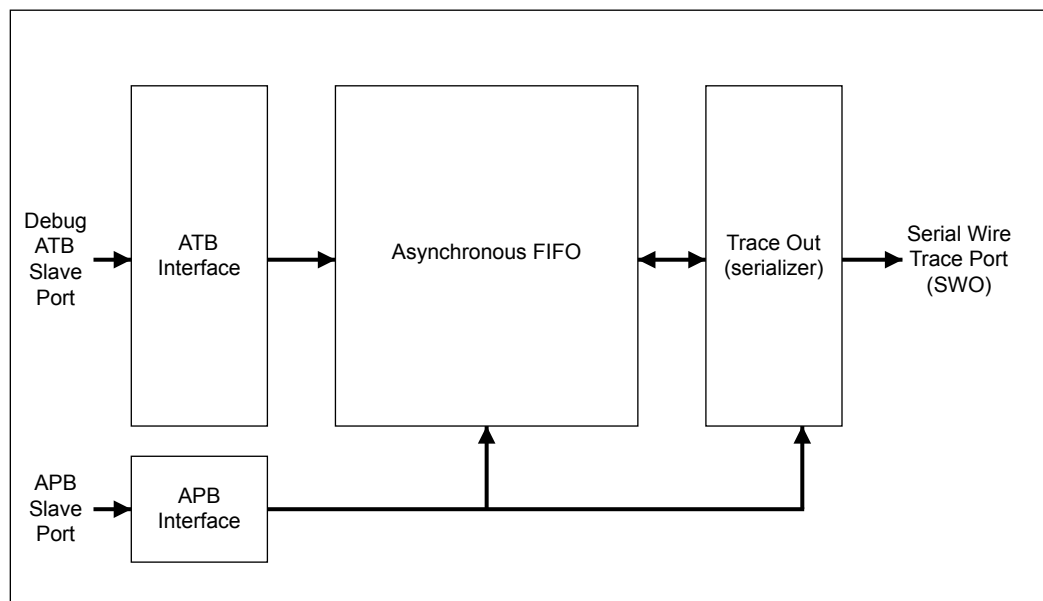

2.2.4 ROM Table

The default ROM table was implemented as described in the *ARM® Cortex™-M3 Technical Reference Manual*.

2.2.5 Memory Protection Unit (MPU)

The Memory Protection Unit (MPU) is included on the LM3S828 controller and supports the standard ARMv7 Protected Memory System Architecture (PMSA) model. The MPU provides full support for protection regions, overlapping protection regions, access permissions, and exporting memory attributes to the system.

2.2.6 Nested Vectored Interrupt Controller (NVIC)

The Nested Vectored Interrupt Controller (NVIC):

- Facilitates low-latency exception and interrupt handling

- Controls power management
- Implements system control registers

The NVIC supports up to 240 dynamically reprioritizable interrupts each with up to 256 levels of priority. The NVIC and the processor core interface are closely coupled, which enables low latency interrupt processing and efficient processing of late arriving interrupts. The NVIC maintains knowledge of the stacked (nested) interrupts to enable tail-chaining of interrupts.

You can only fully access the NVIC from privileged mode, but you can pend interrupts in user-mode if you enable the Configuration Control Register (see the ARM® Cortex™-M3 Technical Reference Manual). Any other user-mode access causes a bus fault.

All NVIC registers are accessible using byte, halfword, and word unless otherwise stated.

2.2.6.1 Interrupts

The *ARM® Cortex™-M3 Technical Reference Manual* describes the maximum number of interrupts and interrupt priorities. The LM3S828 microcontroller supports 22 interrupts with eight priority levels.

2.2.6.2 System Timer (SysTick)

Cortex-M3 includes an integrated system timer, SysTick. SysTick provides a simple, 24-bit clear-on-write, decrementing, wrap-on-zero counter with a flexible control mechanism. The counter can be used in several different ways, for example:

- An RTOS tick timer which fires at a programmable rate (for example, 100 Hz) and invokes a SysTick routine.
- A high-speed alarm timer using the system clock.
- A variable rate alarm or signal timer—the duration is range-dependent on the reference clock used and the dynamic range of the counter.
- A simple counter. Software can use this to measure time to completion and time used.
- An internal clock source control based on missing/meeting durations. The COUNTFLAG bit-field in the control and status register can be used to determine if an action completed within a set duration, as part of a dynamic clock management control loop.

Functional Description

The timer consists of three registers:

- A control and status counter to configure its clock, enable the counter, enable the SysTick interrupt, and determine counter status.
- The reload value for the counter, used to provide the counter's wrap value.
- The current value of the counter.

A fourth register, the SysTick Calibration Value Register, is not implemented in the Stellaris® devices.

When enabled, the timer counts down from the reload value to zero, reloads (wraps) to the value in the SysTick Reload Value register on the next clock edge, then decrements on subsequent clocks. Writing a value of zero to the Reload Value register disables the counter on the next wrap. When the counter reaches zero, the COUNTFLAG status bit is set. The COUNTFLAG bit clears on reads.

Writing to the Current Value register clears the register and the COUNTFLAG status bit. The write does not trigger the SysTick exception logic. On a read, the current value is the value of the register at the time the register is accessed.

If the core is in debug state (halted), the counter will not decrement. The timer is clocked with respect to a reference clock. The reference clock can be the core clock or an external clock source.

SysTick Control and Status Register

Use the SysTick Control and Status Register to enable the SysTick features. The reset is 0x0000.0000.

Bit/Field	Name	Type	Reset	Description
31:17	reserved	RO	0	Software should not rely on the value of a reserved bit. To provide compatibility with future products, the value of a reserved bit should be preserved across a read-modify-write operation.
16	COUNTFLAG	R/W	0	Count Flag Returns 1 if timer counted to 0 since last time this was read. Clears on read by application. If read by the debugger using the DAP, this bit is cleared on read-only if the MasterType bit in the AHB-AP Control Register is set to 0. Otherwise, the COUNTFLAG bit is not changed by the debugger read.
15:3	reserved	RO	0	Software should not rely on the value of a reserved bit. To provide compatibility with future products, the value of a reserved bit should be preserved across a read-modify-write operation.
2	CLKSOURCE	R/W	0	Clock Source Value Description 0 External reference clock. (Not implemented for Stellaris microcontrollers.) 1 Core clock If no reference clock is provided, it is held at 1 and so gives the same time as the core clock. The core clock must be at least 2.5 times faster than the reference clock. If it is not, the count values are unpredictable.
1	TICKINT	R/W	0	Tick Interrupt Value Description 0 Counting down to 0 does not generate the interrupt request to the NVIC. Software can use the COUNTFLAG to determine if ever counted to 0. 1 Counting down to 0 pends the SysTick handler.
0	ENABLE	R/W	0	Enable Value Description 0 Counter disabled. 1 Counter operates in a multi-shot way. That is, counter loads with the Reload value and then begins counting down. On reaching 0, it sets the COUNTFLAG to 1 and optionally pends the SysTick handler, based on TICKINT. It then loads the Reload value again, and begins counting.

SysTick Reload Value Register

Use the SysTick Reload Value Register to specify the start value to load into the current value register when the counter reaches 0. It can be any value between 1 and 0x00FF.FFFF. A start value

of 0 is possible, but has no effect because the SysTick interrupt and COUNTFLAG are activated when counting from 1 to 0.

Therefore, as a multi-shot timer, repeated over and over, it fires every N+1 clock pulse, where N is any value from 1 to 0x00FF.FFFF. So, if the tick interrupt is required every 100 clock pulses, 99 must be written into the RELOAD. If a new value is written on each tick interrupt, so treated as single shot, then the actual count down must be written. For example, if a tick is next required after 400 clock pulses, 400 must be written into the RELOAD.

Bit/Field	Name	Type	Reset	Description
31:24	reserved	RO	0	Software should not rely on the value of a reserved bit. To provide compatibility with future products, the value of a reserved bit should be preserved across a read-modify-write operation.
23:0	RELOAD	W1C	-	Reload Value to load into the SysTick Current Value Register when the counter reaches 0.

SysTick Current Value Register

Use the SysTick Current Value Register to find the current value in the register.

Bit/Field	Name	Type	Reset	Description
31:24	reserved	RO	0	Software should not rely on the value of a reserved bit. To provide compatibility with future products, the value of a reserved bit should be preserved across a read-modify-write operation.
23:0	CURRENT	W1C	-	Current Value Current value at the time the register is accessed. No read-modify-write protection is provided, so change with care. This register is write-clear. Writing to it with any value clears the register to 0. Clearing this register also clears the COUNTFLAG bit of the SysTick Control and Status Register.

SysTick Calibration Value Register

The SysTick Calibration Value register is not implemented.

3 Memory Map

The memory map for the LM3S828 controller is provided in Table 3-1 on page 37.

In this manual, register addresses are given as a hexadecimal increment, relative to the module's base address as shown in the memory map. See also Chapter 4, "Memory Map" in the *ARM® Cortex™-M3 Technical Reference Manual*.

Table 3-1. Memory Map^a

Start	End	Description	For details on registers, see page ...
Memory			
0x0000.0000	0x0000.FFFF	On-chip flash ^b	113
0x0001.0000	0x1FFF.FFFF	Reserved	-
0x2000.0000	0x2000.1FFF	Bit-banded on-chip SRAM ^c	113
0x2000.2000	0x21FF.FFFF	Reserved	-
0x2200.0000	0x2203.FFFF	Bit-band alias of 0x2000.0000 through 0x200F.FFFF	108
0x2204.0000	0x3FFF.FFFF	Reserved	-
FIRM Peripherals			
0x4000.0000	0x4000.0FFF	Watchdog timer	201
0x4000.1000	0x4000.3FFF	Reserved	-
0x4000.4000	0x4000.4FFF	GPIO Port A	131
0x4000.5000	0x4000.5FFF	GPIO Port B	131
0x4000.6000	0x4000.6FFF	GPIO Port C	131
0x4000.7000	0x4000.7FFF	GPIO Port D	131
0x4000.8000	0x4000.8FFF	SSI0	305
0x4000.9000	0x4000.BFFF	Reserved	-
0x4000.C000	0x4000.CFFF	UART0	261
0x4000.D000	0x4000.DFFF	UART1	261
0x4000.E000	0x4001.FFFF	Reserved	-
Peripherals			
0x4002.0000	0x4002.07FF	I2C Master 0	344
0x4002.0800	0x4002.0FFF	I2C Slave 0	357
0x4002.1000	0x4002.3FFF	Reserved	-
0x4002.4000	0x4002.4FFF	GPIO Port E	131
0x4002.5000	0x4002.FFFF	Reserved	-
0x4003.0000	0x4003.0FFF	Timer0	174
0x4003.1000	0x4003.1FFF	Timer1	174
0x4003.2000	0x4003.2FFF	Timer2	174
0x4003.3000	0x4003.7FFF	Reserved	-
0x4003.8000	0x4003.8FFF	ADC	229
0x4003.9000	0x400F.CFFF	Reserved	-
0x400F.D000	0x400F.DFFF	Flash control	113
0x400F.E000	0x400F.EFFF	System control	59

Start	End	Description	For details on registers, see page ...
0x400F.F000	0x41FF.FFFF	Reserved	-
0x4200.0000	0x43FF.FFFF	Bit-banded alias of 0x4000.0000 through 0x400F.FFFF	-
0x4400.0000	0xDFFF.FFFF	Reserved	-
Private Peripheral Bus			
0xE000.0000	0xE000.0FFF	Instrumentation Trace Macrocell (ITM)	ARM® Cortex™-M3 Technical Reference Manual
0xE000.1000	0xE000.1FFF	Data Watchpoint and Trace (DWT)	ARM® Cortex™-M3 Technical Reference Manual
0xE000.2000	0xE000.2FFF	Flash Patch and Breakpoint (FPB)	ARM® Cortex™-M3 Technical Reference Manual
0xE000.3000	0xE000.DFFF	Reserved	-
0xE000.E000	0xE000.EFFF	Nested Vectored Interrupt Controller (NVIC)	ARM® Cortex™-M3 Technical Reference Manual
0xE000.F000	0xE003.FFFF	Reserved	-
0xE004.0000	0xE004.0FFF	Trace Port Interface Unit (TPIU)	ARM® Cortex™-M3 Technical Reference Manual
0xE004.1000	0xFFFF.FFFF	Reserved	-

- a. All reserved space returns a bus fault when read or written.
- b. The unavailable flash will bus fault throughout this range.
- c. The unavailable SRAM will bus fault throughout this range.

4 Interrupts

The ARM Cortex-M3 processor and the Nested Vectored Interrupt Controller (NVIC) prioritize and handle all exceptions. All exceptions are handled in Handler Mode. The processor state is automatically stored to the stack on an exception, and automatically restored from the stack at the end of the Interrupt Service Routine (ISR). The vector is fetched in parallel to the state saving, which enables efficient interrupt entry. The processor supports tail-chaining, which enables back-to-back interrupts to be performed without the overhead of state saving and restoration.

Table 4-1 on page 39 lists all exception types. Software can set eight priority levels on seven of these exceptions (system handlers) as well as on 22 interrupts (listed in Table 4-2 on page 40).

Priorities on the system handlers are set with the NVIC System Handler Priority registers. Interrupts are enabled through the NVIC Interrupt Set Enable register and prioritized with the NVIC Interrupt Priority registers. You also can group priorities by splitting priority levels into pre-emption priorities and subpriorities. All of the interrupt registers are described in Chapter 8, “Nested Vectored Interrupt Controller” in the *ARM® Cortex™-M3 Technical Reference Manual*.

Internally, the highest user-settable priority (0) is treated as fourth priority, after a Reset, NMI, and a Hard Fault. Note that 0 is the default priority for all the settable priorities.

If you assign the same priority level to two or more interrupts, their hardware priority (the lower position number) determines the order in which the processor activates them. For example, if both GPIO Port A and GPIO Port B are priority level 1, then GPIO Port A has higher priority.

See Chapter 5, “Exceptions” and Chapter 8, “Nested Vectored Interrupt Controller” in the *ARM® Cortex™-M3 Technical Reference Manual* for more information on exceptions and interrupts.

Table 4-1. Exception Types

Exception Type	Vector Number	Priority ^a	Description
-	0	-	Stack top is loaded from first entry of vector table on reset.
Reset	1	-3 (highest)	Invoked on power up and warm reset. On first instruction, drops to lowest priority (and then is called the base level of activation). This is asynchronous.
Non-Maskable Interrupt (NMI)	2	-2	Cannot be stopped or preempted by any exception but reset. This is asynchronous. An NMI is only producible by software, using the NVIC Interrupt Control State register.
Hard Fault	3	-1	All classes of Fault, when the fault cannot activate due to priority or the configurable fault handler has been disabled. This is synchronous.
Memory Management	4	settable	MPU mismatch, including access violation and no match. This is synchronous. The priority of this exception can be changed.
Bus Fault	5	settable	Pre-fetch fault, memory access fault, and other address/memory related faults. This is synchronous when precise and asynchronous when imprecise. You can enable or disable this fault.
Usage Fault	6	settable	Usage fault, such as undefined instruction executed or illegal state transition attempt. This is synchronous.
-	7-10	-	Reserved.
SVCcall	11	settable	System service call with SVC instruction. This is synchronous.

Exception Type	Vector Number	Priority ^a	Description
Debug Monitor	12	settable	Debug monitor (when not halting). This is synchronous, but only active when enabled. It does not activate if lower priority than the current activation.
-	13	-	Reserved.
PendSV	14	settable	Pendable request for system service. This is asynchronous and only pended by software.
SysTick	15	settable	System tick timer has fired. This is asynchronous.
Interrupts	16 and above	settable	Asserted from outside the ARM Cortex-M3 core and fed through the NVIC (prioritized). These are all asynchronous. Table 4-2 on page 40 lists the interrupts on the LM3S828 controller.

a. 0 is the default priority for all the settable priorities.

Table 4-2. Interrupts

Vector Number	Interrupt Number (Bit in Interrupt Registers)	Description
0-15	-	Processor exceptions
16	0	GPIO Port A
17	1	GPIO Port B
18	2	GPIO Port C
19	3	GPIO Port D
20	4	GPIO Port E
21	5	UART0
22	6	UART1
23	7	SSI0
24	8	I2C0
25-29	9-13	Reserved
30	14	ADC Sequence 0
31	15	ADC Sequence 1
32	16	ADC Sequence 2
33	17	ADC Sequence 3
34	18	Watchdog timer
35	19	Timer0 A
36	20	Timer0 B
37	21	Timer1 A
38	22	Timer1 B
39	23	Timer2 A
40	24	Timer2 B
41-43	25-27	Reserved
44	28	System Control
45	29	Flash Control
46-63	30-47	Reserved

5 JTAG Interface

The Joint Test Action Group (JTAG) port is an IEEE standard that defines a Test Access Port and Boundary Scan Architecture for digital integrated circuits and provides a standardized serial interface for controlling the associated test logic. The TAP, Instruction Register (IR), and Data Registers (DR) can be used to test the interconnections of assembled printed circuit boards and obtain manufacturing information on the components. The JTAG Port also provides a means of accessing and controlling design-for-test features such as I/O pin observation and control, scan testing, and debugging.

The JTAG port is comprised of five pins: $\overline{\text{TRST}}$, TCK, TMS, TDI, and TDO. Data is transmitted serially into the controller on TDI and out of the controller on TDO. The interpretation of this data is dependent on the current state of the TAP controller. For detailed information on the operation of the JTAG port and TAP controller, please refer to the *IEEE Standard 1149.1-Test Access Port and Boundary-Scan Architecture*.

The Luminary Micro JTAG controller works with the ARM JTAG controller built into the Cortex-M3 core. This is implemented by multiplexing the TDO outputs from both JTAG controllers. ARM JTAG instructions select the ARM TDO output while Luminary Micro JTAG instructions select the Luminary Micro TDO outputs. The multiplexer is controlled by the Luminary Micro JTAG controller, which has comprehensive programming for the ARM, Luminary Micro, and unimplemented JTAG instructions.

The JTAG module has the following features:

- IEEE 1149.1-1990 compatible Test Access Port (TAP) controller
- Four-bit Instruction Register (IR) chain for storing JTAG instructions
- IEEE standard instructions:
 - BYPASS instruction
 - IDCODE instruction
 - SAMPLE/PRELOAD instruction
 - EXTEST instruction
 - INTEST instruction
- ARM additional instructions:
 - APACC instruction
 - DPACC instruction
 - ABORT instruction
- Integrated ARM Serial Wire Debug (SWD)

See the *ARM® Cortex™-M3 Technical Reference Manual* for more information on the ARM JTAG controller.

5.1 Block Diagram

Figure 5-1. JTAG Module Block Diagram

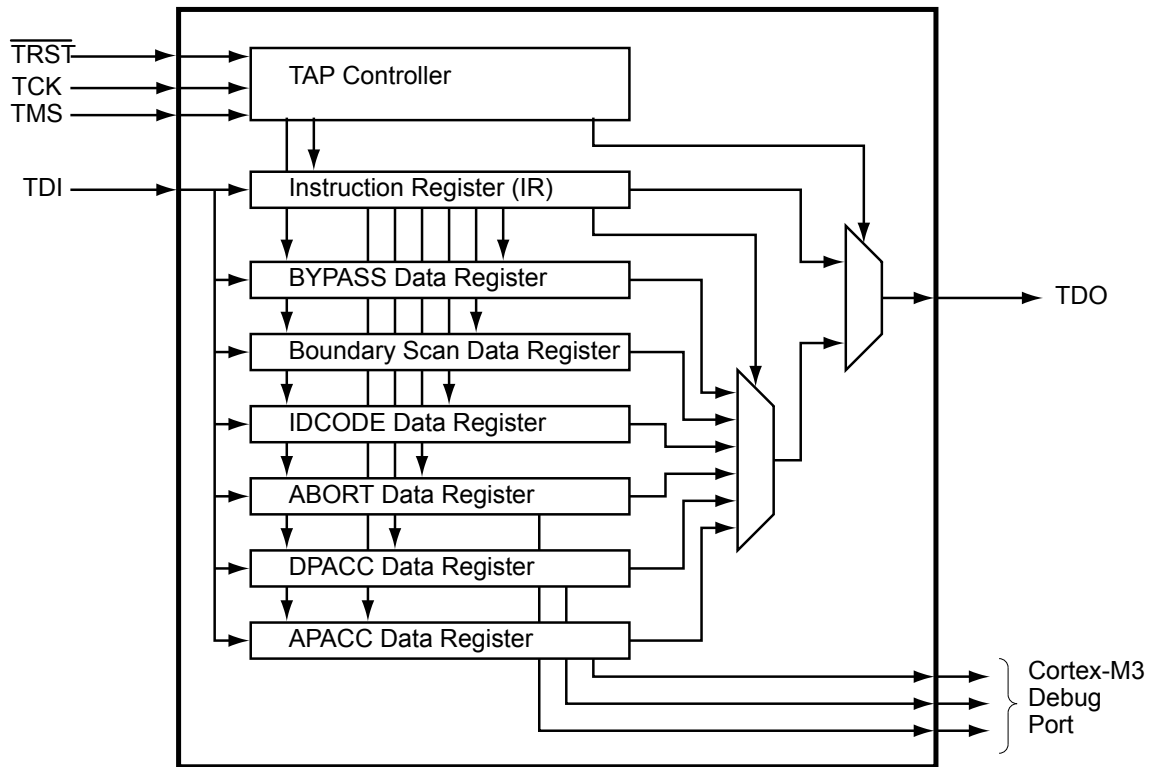

5.2 Functional Description

A high-level conceptual drawing of the JTAG module is shown in Figure 5-1 on page 42. The JTAG module is composed of the Test Access Port (TAP) controller and serial shift chains with parallel update registers. The TAP controller is a simple state machine controlled by the $\overline{\text{TRST}}$, TCK and TMS inputs. The current state of the TAP controller depends on the current value of $\overline{\text{TRST}}$ and the sequence of values captured on TMS at the rising edge of TCK. The TAP controller determines when the serial shift chains capture new data, shift data from TDI towards TDO, and update the parallel load registers. The current state of the TAP controller also determines whether the Instruction Register (IR) chain or one of the Data Register (DR) chains is being accessed.

The serial shift chains with parallel load registers are comprised of a single Instruction Register (IR) chain and multiple Data Register (DR) chains. The current instruction loaded in the parallel load register determines which DR chain is captured, shifted, or updated during the sequencing of the TAP controller.

Some instructions, like EXTEST and INTEST, operate on data currently in a DR chain and do not capture, shift, or update any of the chains. Instructions that are not implemented decode to the BYPASS instruction to ensure that the serial path between TDI and TDO is always connected (see Table 5-2 on page 47 for a list of implemented instructions).

See “JTAG and Boundary Scan” on page 380 for JTAG timing diagrams.

5.2.1 JTAG Interface Pins

The JTAG interface consists of five standard pins: $\overline{\text{TRST}}$, TCK, TMS, TDI, and TDO. These pins and their associated reset state are given in Table 5-1 on page 43. Detailed information on each pin follows.

Table 5-1. JTAG Port Pins Reset State

Pin Name	Data Direction	Internal Pull-Up	Internal Pull-Down	Drive Strength	Drive Value
$\overline{\text{TRST}}$	Input	Enabled	Disabled	N/A	N/A
TCK	Input	Enabled	Disabled	N/A	N/A
TMS	Input	Enabled	Disabled	N/A	N/A
TDI	Input	Enabled	Disabled	N/A	N/A
TDO	Output	Enabled	Disabled	2-mA driver	High-Z

5.2.1.1 Test Reset Input ($\overline{\text{TRST}}$)

The $\overline{\text{TRST}}$ pin is an asynchronous active Low input signal for initializing and resetting the JTAG TAP controller and associated JTAG circuitry. When $\overline{\text{TRST}}$ is asserted, the TAP controller resets to the Test-Logic-Reset state and remains there while $\overline{\text{TRST}}$ is asserted. When the TAP controller enters the Test-Logic-Reset state, the JTAG Instruction Register (IR) resets to the default instruction, IDCODE.

By default, the internal pull-up resistor on the $\overline{\text{TRST}}$ pin is enabled after reset. Changes to the pull-up resistor settings on GPIO Port B should ensure that the internal pull-up resistor remains enabled on PB7/ $\overline{\text{TRST}}$; otherwise JTAG communication could be lost.

5.2.1.2 Test Clock Input (TCK)

The TCK pin is the clock for the JTAG module. This clock is provided so the test logic can operate independently of any other system clocks. In addition, it ensures that multiple JTAG TAP controllers that are daisy-chained together can synchronously communicate serial test data between components. During normal operation, TCK is driven by a free-running clock with a nominal 50% duty cycle. When necessary, TCK can be stopped at 0 or 1 for extended periods of time. While TCK is stopped at 0 or 1, the state of the TAP controller does not change and data in the JTAG Instruction and Data Registers is not lost.

By default, the internal pull-up resistor on the TCK pin is enabled after reset. This assures that no clocking occurs if the pin is not driven from an external source. The internal pull-up and pull-down resistors can be turned off to save internal power as long as the TCK pin is constantly being driven by an external source.

5.2.1.3 Test Mode Select (TMS)

The TMS pin selects the next state of the JTAG TAP controller. TMS is sampled on the rising edge of TCK. Depending on the current TAP state and the sampled value of TMS, the next state is entered. Because the TMS pin is sampled on the rising edge of TCK, the *IEEE Standard 1149.1* expects the value on TMS to change on the falling edge of TCK.

Holding TMS high for five consecutive TCK cycles drives the TAP controller state machine to the Test-Logic-Reset state. When the TAP controller enters the Test-Logic-Reset state, the JTAG Instruction Register (IR) resets to the default instruction, IDCODE. Therefore, this sequence can be used as a reset mechanism, similar to asserting $\overline{\text{TRST}}$. The JTAG Test Access Port state machine can be seen in its entirety in Figure 5-2 on page 45.

By default, the internal pull-up resistor on the TMS pin is enabled after reset. Changes to the pull-up resistor settings on GPIO Port C should ensure that the internal pull-up resistor remains enabled on PC1/TMS; otherwise JTAG communication could be lost.

5.2.1.4 Test Data Input (TDI)

The TDI pin provides a stream of serial information to the IR chain and the DR chains. TDI is sampled on the rising edge of TCK and, depending on the current TAP state and the current instruction, presents this data to the proper shift register chain. Because the TDI pin is sampled on the rising edge of TCK, the *IEEE Standard 1149.1* expects the value on TDI to change on the falling edge of TCK.

By default, the internal pull-up resistor on the TDI pin is enabled after reset. Changes to the pull-up resistor settings on GPIO Port C should ensure that the internal pull-up resistor remains enabled on PC2/TDI; otherwise JTAG communication could be lost.

5.2.1.5 Test Data Output (TDO)

The TDO pin provides an output stream of serial information from the IR chain or the DR chains. The value of TDO depends on the current TAP state, the current instruction, and the data in the chain being accessed. In order to save power when the JTAG port is not being used, the TDO pin is placed in an inactive drive state when not actively shifting out data. Because TDO can be connected to the TDI of another controller in a daisy-chain configuration, the *IEEE Standard 1149.1* expects the value on TDO to change on the falling edge of TCK.

By default, the internal pull-up resistor on the TDO pin is enabled after reset. This assures that the pin remains at a constant logic level when the JTAG port is not being used. The internal pull-up and pull-down resistors can be turned off to save internal power if a High-Z output value is acceptable during certain TAP controller states.

5.2.2 JTAG TAP Controller

The JTAG TAP controller state machine is shown in Figure 5-2 on page 45. The TAP controller state machine is reset to the Test-Logic-Reset state on the assertion of a Power-On-Reset (POR) or the assertion of $\overline{\text{TRST}}$. Asserting the correct sequence on the TMS pin allows the JTAG module to shift in new instructions, shift in data, or idle during extended testing sequences. For detailed information on the function of the TAP controller and the operations that occur in each state, please refer to *IEEE Standard 1149.1*.

Figure 5-2. Test Access Port State Machine

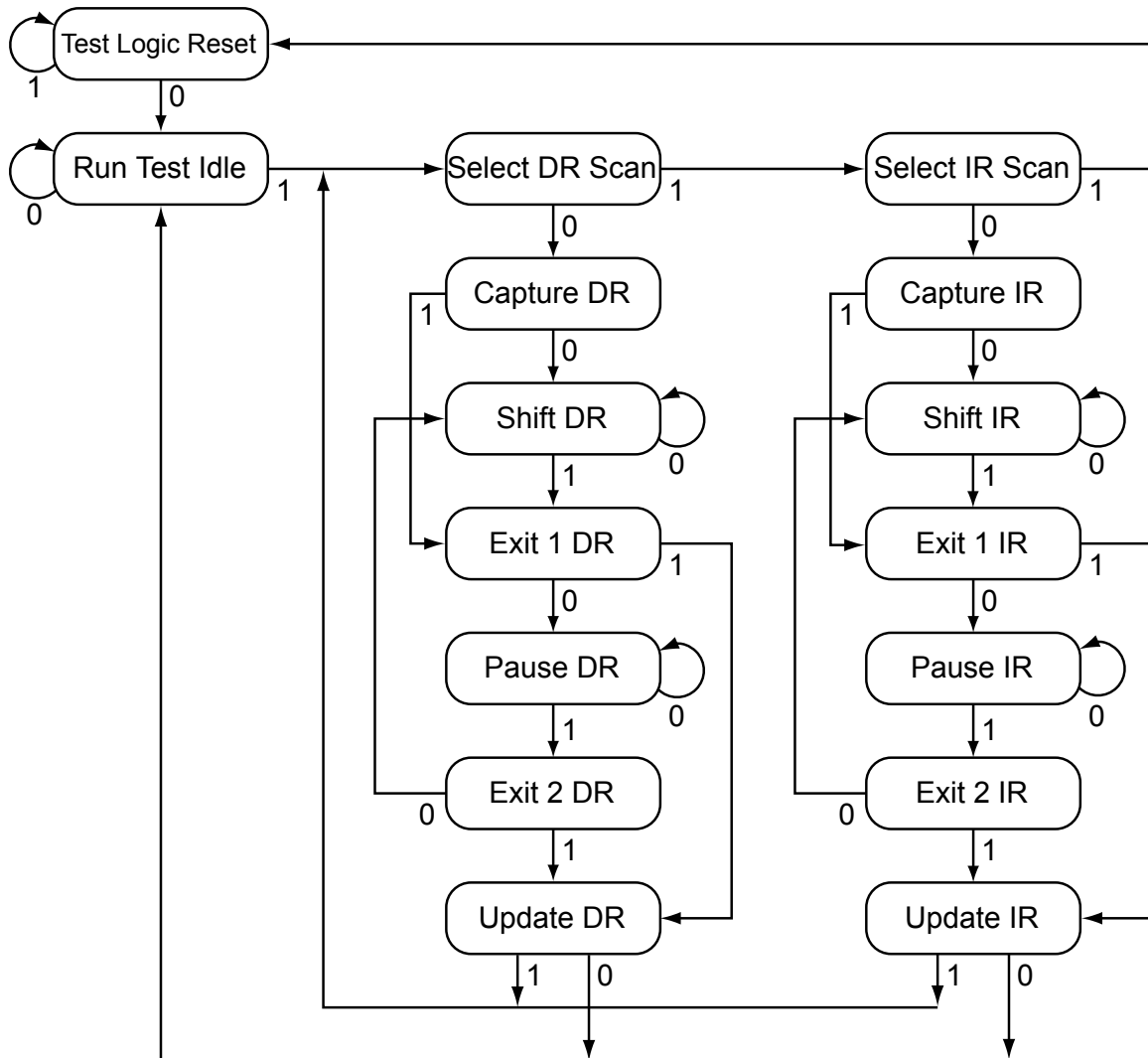

5.2.3 Shift Registers

The Shift Registers consist of a serial shift register chain and a parallel load register. The serial shift register chain samples specific information during the TAP controller's CAPTURE states and allows this information to be shifted out of TDO during the TAP controller's SHIFT states. While the sampled data is being shifted out of the chain on TDO, new data is being shifted into the serial shift register on TDI. This new data is stored in the parallel load register during the TAP controller's UPDATE states. Each of the shift registers is discussed in detail in "Register Descriptions" on page 47.

5.2.4 Operational Considerations

There are certain operational considerations when using the JTAG module. Because the JTAG pins can be programmed to be GPIOs, board configuration and reset conditions on these pins must be considered. In addition, because the JTAG module has integrated ARM Serial Wire Debug, the method for switching between these two operational modes is described below.

5.2.4.1 GPIO Functionality

When the controller is reset with either a POR or $\overline{\text{RST}}$, the JTAG port pins default to their JTAG configurations. The default configuration includes enabling the pull-up resistors (setting **GPIOPUR** to 1 for PB7 and $\text{PC}[3:0]$) and enabling the alternate hardware function (setting **GPIOAFSEL** to 1 for PB7 and $\text{PC}[3:0]$) on the JTAG pins.

It is possible for software to configure these pins as GPIOs after reset by writing 0s to PB7 and $\text{PC}[3:0]$ in the **GPIOAFSEL** register. If the user does not require the JTAG port for debugging or board-level testing, this provides five more GPIOs for use in the design.

Caution – If the JTAG pins are used as GPIOs in a design, PB7 and PC2 cannot have external pull-down resistors connected to both of them at the same time. If both pins are pulled Low during reset, the controller has unpredictable behavior. If this happens, remove one or both of the pull-down resistors, and apply $\overline{\text{RST}}$ or power-cycle the part.

It is possible to create a software sequence that prevents the debugger from connecting to the Stellaris[®] microcontroller. If the program code loaded into flash immediately changes the JTAG pins to their GPIO functionality, the debugger may not have enough time to connect and halt the controller before the JTAG pin functionality switches. This may lock the debugger out of the part. This can be avoided with a software routine that restores JTAG functionality based on an external or software trigger.

5.2.4.2 ARM Serial Wire Debug (SWD)

In order to seamlessly integrate the ARM Serial Wire Debug (SWD) functionality, a serial-wire debugger must be able to connect to the Cortex-M3 core without having to perform, or have any knowledge of, JTAG cycles. This is accomplished with a SWD preamble that is issued before the SWD session begins.

The preamble used to enable the SWD interface of the SWJ-DP module starts with the TAP controller in the Test-Logic-Reset state. From here, the preamble sequences the TAP controller through the following states: Run Test Idle, Select DR, Select IR, Capture IR, Exit1 IR, Update IR, Run Test Idle, Select DR, Select IR, Capture IR, Exit1 IR, Update IR, Run Test Idle, Select DR, Select IR, and Test-Logic-Reset states.

Stepping through the JTAG TAP Instruction Register (IR) load sequences of the TAP state machine twice without shifting in a new instruction enables the SWD interface and disables the JTAG interface. For more information on this operation and the SWD interface, see the *ARM[®] Cortex[™]-M3 Technical Reference Manual* and the *ARM[®] CoreSight Technical Reference Manual*.

Because this sequence is a valid series of JTAG operations that could be issued, the ARM JTAG TAP controller is not fully compliant to the *IEEE Standard 1149.1*. This is the only instance where the ARM JTAG TAP controller does not meet full compliance with the specification. Due to the low probability of this sequence occurring during normal operation of the TAP controller, it should not affect normal performance of the JTAG interface.

5.3 Initialization and Configuration

After a Power-On-Reset or an external reset ($\overline{\text{RST}}$), the JTAG pins are automatically configured for JTAG communication. No user-defined initialization or configuration is needed. However, if the user application changes these pins to their GPIO function, they must be configured back to their JTAG functionality before JTAG communication can be restored. This is done by enabling the five JTAG pins (PB7 and $\text{PC}[3:0]$) for their alternate function using the **GPIOAFSEL** register.

5.4 Register Descriptions

There are no APB-accessible registers in the JTAG TAP Controller or Shift Register chains. The registers within the JTAG controller are all accessed serially through the TAP Controller. The registers can be broken down into two main categories: Instruction Registers and Data Registers.

5.4.1 Instruction Register (IR)

The JTAG TAP Instruction Register (IR) is a four-bit serial scan chain with a parallel load register connected between the JTAG TDI and TDO pins. When the TAP Controller is placed in the correct states, bits can be shifted into the Instruction Register. Once these bits have been shifted into the chain and updated, they are interpreted as the current instruction. The decode of the Instruction Register bits is shown in Table 5-2 on page 47. A detailed explanation of each instruction, along with its associated Data Register, follows.

Table 5-2. JTAG Instruction Register Commands

IR[3:0]	Instruction	Description
0000	EXTEST	Drives the values preloaded into the Boundary Scan Chain by the SAMPLE/PRELOAD instruction onto the pads.
0001	INTEST	Drives the values preloaded into the Boundary Scan Chain by the SAMPLE/PRELOAD instruction into the controller.
0010	SAMPLE / PRELOAD	Captures the current I/O values and shifts the sampled values out of the Boundary Scan Chain while new preload data is shifted in.
1000	ABORT	Shifts data into the ARM Debug Port Abort Register.
1010	DPACC	Shifts data into and out of the ARM DP Access Register.
1011	APACC	Shifts data into and out of the ARM AC Access Register.
1110	IDCODE	Loads manufacturing information defined by the <i>IEEE Standard 1149.1</i> into the IDCODE chain and shifts it out.
1111	BYPASS	Connects TDI to TDO through a single Shift Register chain.
All Others	Reserved	Defaults to the BYPASS instruction to ensure that TDI is always connected to TDO.

5.4.1.1 EXTEST Instruction

The EXTEST instruction does not have an associated Data Register chain. The EXTEST instruction uses the data that has been preloaded into the Boundary Scan Data Register using the SAMPLE/PRELOAD instruction. When the EXTEST instruction is present in the Instruction Register, the preloaded data in the Boundary Scan Data Register associated with the outputs and output enables are used to drive the GPIO pads rather than the signals coming from the core. This allows tests to be developed that drive known values out of the controller, which can be used to verify connectivity.

5.4.1.2 INTEST Instruction

The INTEST instruction does not have an associated Data Register chain. The INTEST instruction uses the data that has been preloaded into the Boundary Scan Data Register using the SAMPLE/PRELOAD instruction. When the INTEST instruction is present in the Instruction Register, the preloaded data in the Boundary Scan Data Register associated with the inputs are used to drive the signals going into the core rather than the signals coming from the GPIO pads. This allows tests to be developed that drive known values into the controller, which can be used for testing. It is important to note that although the $\overline{\text{RST}}$ input pin is on the Boundary Scan Data Register chain, it is only observable.

5.4.1.3 SAMPLE/PRELOAD Instruction

The SAMPLE/PRELOAD instruction connects the Boundary Scan Data Register chain between TDI and TDO. This instruction samples the current state of the pad pins for observation and preloads new test data. Each GPIO pad has an associated input, output, and output enable signal. When the TAP controller enters the Capture DR state during this instruction, the input, output, and output-enable signals to each of the GPIO pads are captured. These samples are serially shifted out of TDO while the TAP controller is in the Shift DR state and can be used for observation or comparison in various tests.

While these samples of the inputs, outputs, and output enables are being shifted out of the Boundary Scan Data Register, new data is being shifted into the Boundary Scan Data Register from TDI. Once the new data has been shifted into the Boundary Scan Data Register, the data is saved in the parallel load registers when the TAP controller enters the Update DR state. This update of the parallel load register preloads data into the Boundary Scan Data Register that is associated with each input, output, and output enable. This preloaded data can be used with the EXTEST and INTEST instructions to drive data into or out of the controller. Please see “Boundary Scan Data Register” on page 49 for more information.

5.4.1.4 ABORT Instruction

The ABORT instruction connects the associated ABORT Data Register chain between TDI and TDO. This instruction provides read and write access to the ABORT Register of the ARM Debug Access Port (DAP). Shifting the proper data into this Data Register clears various error bits or initiates a DAP abort of a previous request. Please see the “ABORT Data Register” on page 50 for more information.

5.4.1.5 DPACC Instruction

The DPACC instruction connects the associated DPACC Data Register chain between TDI and TDO. This instruction provides read and write access to the DPACC Register of the ARM Debug Access Port (DAP). Shifting the proper data into this register and reading the data output from this register allows read and write access to the ARM debug and status registers. Please see “DPACC Data Register” on page 50 for more information.

5.4.1.6 APACC Instruction

The APACC instruction connects the associated APACC Data Register chain between TDI and TDO. This instruction provides read and write access to the APACC Register of the ARM Debug Access Port (DAP). Shifting the proper data into this register and reading the data output from this register allows read and write access to internal components and buses through the Debug Port. Please see “APACC Data Register” on page 50 for more information.

5.4.1.7 IDCODE Instruction

The IDCODE instruction connects the associated IDCODE Data Register chain between TDI and TDO. This instruction provides information on the manufacturer, part number, and version of the ARM core. This information can be used by testing equipment and debuggers to automatically configure their input and output data streams. IDCODE is the default instruction that is loaded into the JTAG Instruction Register when a power-on-reset (POR) is asserted, TRST is asserted, or the Test-Logic-Reset state is entered. Please see “IDCODE Data Register” on page 49 for more information.

5.4.1.8 BYPASS Instruction

The BYPASS instruction connects the associated BYPASS Data Register chain between TDI and TDO. This instruction is used to create a minimum length serial path between the TDI and TDO ports. The BYPASS Data Register is a single-bit shift register. This instruction improves test efficiency by allowing components that are not needed for a specific test to be bypassed in the JTAG scan chain by loading them with the BYPASS instruction. Please see “BYPASS Data Register” on page 49 for more information.

5.4.2 Data Registers

The JTAG module contains six Data Registers. These include: IDCODE, BYPASS, Boundary Scan, APACC, DPACC, and ABORT serial Data Register chains. Each of these Data Registers is discussed in the following sections.

5.4.2.1 IDCODE Data Register

The format for the 32-bit IDCODE Data Register defined by the *IEEE Standard 1149.1* is shown in Figure 5-3 on page 49. The standard requires that every JTAG-compliant device implement either the IDCODE instruction or the BYPASS instruction as the default instruction. The LSB of the IDCODE Data Register is defined to be a 1 to distinguish it from the BYPASS instruction, which has an LSB of 0. This allows auto configuration test tools to determine which instruction is the default instruction.

The major uses of the JTAG port are for manufacturer testing of component assembly, and program development and debug. To facilitate the use of auto-configuration debug tools, the IDCODE instruction outputs a value of 0x1BA00477. This value indicates an ARM Cortex-M3, Version 1 processor. This allows the debuggers to automatically configure themselves to work correctly with the Cortex-M3 during debug.

Figure 5-3. IDCODE Register Format

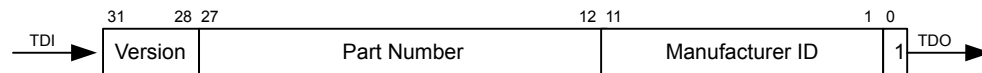

5.4.2.2 BYPASS Data Register

The format for the 1-bit BYPASS Data Register defined by the *IEEE Standard 1149.1* is shown in Figure 5-4 on page 49. The standard requires that every JTAG-compliant device implement either the BYPASS instruction or the IDCODE instruction as the default instruction. The LSB of the BYPASS Data Register is defined to be a 0 to distinguish it from the IDCODE instruction, which has an LSB of 1. This allows auto configuration test tools to determine which instruction is the default instruction.

Figure 5-4. BYPASS Register Format

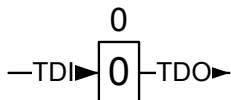

5.4.2.3 Boundary Scan Data Register

The format of the Boundary Scan Data Register is shown in Figure 5-5 on page 50. Each GPIO pin, in a counter-clockwise direction from the JTAG port pins, is included in the Boundary Scan Data

Register. Each GPIO pin has three associated digital signals that are included in the chain. These signals are input, output, and output enable, and are arranged in that order as can be seen in the figure. In addition to the GPIO pins, the controller reset pin, \overline{RST} , is included in the chain. Because the reset pin is always an input, only the input signal is included in the Data Register chain.

When the Boundary Scan Data Register is accessed with the SAMPLE/PRELOAD instruction, the input, output, and output enable from each digital pad are sampled and then shifted out of the chain to be verified. The sampling of these values occurs on the rising edge of TCK in the Capture DR state of the TAP controller. While the sampled data is being shifted out of the Boundary Scan chain in the Shift DR state of the TAP controller, new data can be preloaded into the chain for use with the EXTEST and INTEST instructions. These instructions either force data out of the controller, with the EXTEST instruction, or into the controller, with the INTEST instruction.

Figure 5-5. Boundary Scan Register Format

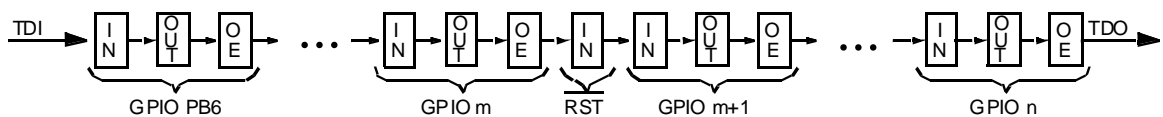

For detailed information on the order of the input, output, and output enable bits for each of the GPIO ports, please refer to the Stellaris[®] Family Boundary Scan Description Language (BSDL) files, downloadable from www.luminarymicro.com.

5.4.2.4 APACC Data Register

The format for the 35-bit APACC Data Register defined by ARM is described in the *ARM[®] Cortex[™]-M3 Technical Reference Manual*.

5.4.2.5 DPACC Data Register

The format for the 35-bit DPACC Data Register defined by ARM is described in the *ARM[®] Cortex[™]-M3 Technical Reference Manual*.

5.4.2.6 ABORT Data Register

The format for the 35-bit ABORT Data Register defined by ARM is described in the *ARM[®] Cortex[™]-M3 Technical Reference Manual*.

6 System Control

System control determines the overall operation of the device. It provides information about the device, controls the clocking to the core and individual peripherals, and handles reset detection and reporting.

6.1 Functional Description

The System Control module provides the following capabilities:

- Device identification, see “Device Identification” on page 51
- Local control, such as reset (see “Reset Control” on page 51), power (see “Power Control” on page 54) and clock control (see “Clock Control” on page 54)
- System control (Run, Sleep, and Deep-Sleep modes), see “System Control” on page 57

6.1.1 Device Identification

Seven read-only registers provide software with information on the microcontroller, such as version, part number, SRAM size, flash size, and other features. See the **DID0**, **DID1**, and **DC0-DC4** registers.

6.1.2 Reset Control

This section discusses aspects of hardware functions during reset as well as system software requirements following the reset sequence.

6.1.2.1 Reset Sources

The controller has six sources of reset:

1. External reset input pin ($\overline{\text{RST}}$) assertion, see “ $\overline{\text{RST}}$ Pin Assertion” on page 51.
2. Power-on reset (POR), see “Power-On Reset (POR)” on page 52.
3. Internal brown-out (BOR) detector, see “Brown-Out Reset (BOR)” on page 52.
4. Software-initiated reset (with the software reset registers), see “Software Reset” on page 53.
5. A watchdog timer reset condition violation, see “Watchdog Timer Reset” on page 54.
6. Internal low drop-out (LDO) regulator output

After a reset, the **Reset Cause (RESC)** register is set with the reset cause. The bits in this register are sticky and maintain their state across multiple reset sequences, except when an external reset is the cause, and then all the other bits in the **RESC** register are cleared.

Note: The main oscillator is used for external resets and power-on resets; the internal oscillator is used during the internal process by internal reset and clock verification circuitry.

6.1.2.2 $\overline{\text{RST}}$ Pin Assertion

The external reset pin ($\overline{\text{RST}}$) resets the controller. This resets the core and all the peripherals except the JTAG TAP controller (see “JTAG Interface” on page 41). The external reset sequence is as follows:

1. The external reset pin ($\overline{\text{RST}}$) is asserted and then de-asserted.
2. After $\overline{\text{RST}}$ is de-asserted, the main crystal oscillator is allowed to settle and there is an internal main oscillator counter that takes from 15-30 ms to account for this. During this time, internal reset to the rest of the controller is held active.
3. The internal reset is released and the core fetches and loads the initial stack pointer, the initial program counter, the first instruction designated by the program counter, and begins execution.

The external reset timing is shown in Figure 18-9 on page 382.

6.1.2.3 Power-On Reset (POR)

The Power-On Reset (POR) circuitry detects a rise in power-supply voltage (V_{DD}) and generates an on-chip reset pulse. To use the on-chip circuitry, the $\overline{\text{RST}}$ input needs to be connected to the power supply (V_{DD}) through a pull-up resistor (1K to 10K Ω).

The device must be operating within the specified operating parameters at the point when the on-chip power-on reset pulse is complete. The specified operating parameters include supply voltage, frequency, temperature, and so on. If the operating conditions are not met at the point of POR end, the Stellaris[®] controller does not operate correctly. In this case, the reset must be extended using external circuitry. The $\overline{\text{RST}}$ input may be used with the circuit as shown in Figure 6-1 on page 52.

Figure 6-1. External Circuitry to Extend Reset

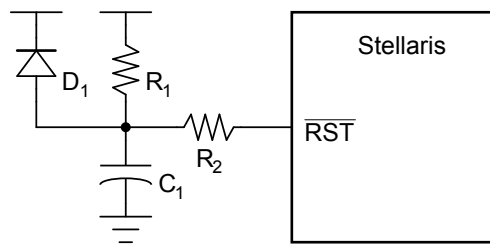

The R_1 and C_1 components define the power-on delay. The R_2 resistor mitigates any leakage from the $\overline{\text{RST}}$ input. The diode (D_1) discharges C_1 rapidly when the power supply is turned off.

The Power-On Reset sequence is as follows:

1. The controller waits for the later of external reset ($\overline{\text{RST}}$) or internal POR to go inactive.
2. After the resets are inactive, the main crystal oscillator is allowed to settle and there is an internal main oscillator counter that takes from 15-30 ms to account for this. During this time, internal reset to the rest of the controller is held active.
3. The internal reset is released and the core fetches and loads the initial stack pointer, the initial program counter, the first instruction designated by the program counter, and begins execution.

The internal POR is only active on the initial power-up of the controller. The Power-On Reset timing is shown in Figure 18-10 on page 383.

Note: The power-on reset also resets the JTAG controller. An external reset does not.

6.1.2.4 Brown-Out Reset (BOR)

A drop in the input voltage resulting in the assertion of the internal brown-out detector can be used to reset the controller. This is initially disabled and may be enabled by software.

The system provides a brown-out detection circuit that triggers if the power supply (V_{DD}) drops below a brown-out threshold voltage (V_{BTH}). The circuit is provided to guard against improper operation of logic and peripherals that operate off the power supply voltage (V_{DD}) and not the LDO voltage. If a brown-out condition is detected, the system may generate a controller interrupt or a system reset. The BOR circuit has a digital filter that protects against noise-related detection for the interrupt condition. This feature may be optionally enabled.

Brown-out resets are controlled with the **Power-On and Brown-Out Reset Control (PBORCTL)** register. The `BORIOR` bit in the **PBORCTL** register must be set for a brown-out condition to trigger a reset.

The brown-out reset sequence is as follows:

1. When V_{DD} drops below V_{BTH} , an internal BOR condition is set.
2. If the `BORWT` bit in the **PBORCTL** register is set and `BORIOR` is not set, the BOR condition is resampled again, after a delay specified by `BORTIM`, to determine if the original condition was caused by noise. If the BOR condition is not met the second time, then no further action is taken.
3. If the BOR condition exists, an internal reset is asserted.
4. The internal reset is released and the controller fetches and loads the initial stack pointer, the initial program counter, the first instruction designated by the program counter, and begins execution.
5. The internal BOR condition is reset after 500 μ s to prevent another BOR condition from being set before software has a chance to investigate the original cause.

The internal Brown-Out Reset timing is shown in Figure 18-11 on page 383.

6.1.2.5 Software Reset

Software can reset a specific peripheral or generate a reset to the entire system .

Peripherals can be individually reset by software via three registers that control reset signals to each peripheral (see the **SRCRn** registers). If the bit position corresponding to a peripheral is set and subsequently cleared, the peripheral is reset. The encoding of the reset registers is consistent with the encoding of the clock gating control for peripherals and on-chip functions (see “System Control” on page 57). Note that all reset signals for all clocks of the specified unit are asserted as a result of a software-initiated reset.

The entire system can be reset by software by setting the `SYSRESETREQ` bit in the Cortex-M3 Application Interrupt and Reset Control register resets the entire system including the core. The software-initiated system reset sequence is as follows:

1. A software system reset is initiated by writing the `SYSRESETREQ` bit in the ARM Cortex-M3 Application Interrupt and Reset Control register.
2. An internal reset is asserted.
3. The internal reset is deasserted and the controller loads from memory the initial stack pointer, the initial program counter, and the first instruction designated by the program counter, and then begins execution.

The software-initiated system reset timing is shown in Figure 18-12 on page 383.

6.1.2.6 Watchdog Timer Reset

The watchdog timer module's function is to prevent system hangs. The watchdog timer can be configured to generate an interrupt to the controller on its first time-out, and to generate a reset signal on its second time-out.

After the first time-out event, the 32-bit counter is reloaded with the value of the **Watchdog Timer Load (WDTLOAD)** register, and the timer resumes counting down from that value. If the timer counts down to its zero state again before the first time-out interrupt is cleared, and the reset signal has been enabled, the watchdog timer asserts its reset signal to the system. The watchdog timer reset sequence is as follows:

1. The watchdog timer times out for the second time without being serviced.
2. An internal reset is asserted.
3. The internal reset is released and the controller loads from memory the initial stack pointer, the initial program counter, the first instruction designated by the program counter, and begins execution.

The watchdog reset timing is shown in Figure 18-13 on page 384.

6.1.2.7 Low Drop-Out

A reset can be initiated when the internal low drop-out (LDO) regulator output goes unregulated. This is initially disabled and may be enabled by software. LDO is controlled with the **LDO Power Control (LDOPCTL)** register. The LDO reset sequence is as follows:

1. LDO goes unregulated and the `LDOARST` bit in the **LDOARST** register is set.
2. An internal reset is asserted.
3. The internal reset is released and the controller fetches and loads the initial stack pointer, the initial program counter, the first instruction designated by the program counter, and begins execution.

The LDO reset timing is shown in Figure 18-14 on page 384.

6.1.3 Power Control

The Stellaris[®] microcontroller provides an integrated LDO regulator that is used to provide power to the majority of the controller's internal logic. The LDO regulator provides software a mechanism to adjust the regulated value, in small increments (VSTEP), over the range of 2.25 V to 2.75 V (inclusive)—or $2.5\text{ V} \pm 10\%$. The adjustment is made by changing the value of the `VADJ` field in the **LDO Power Control (LDOPCTL)** register.

6.1.4 Clock Control

System control determines the control of clocks in this part.

6.1.4.1 Fundamental Clock Sources

There are two clock sources for use in the device:

- **Internal Oscillator (IOSC):** The internal oscillator is an on-chip clock source. It does not require the use of any external components. The frequency of the internal oscillator is $12\text{ MHz} \pm 30\%$.

Applications that do not depend on accurate clock sources may use this clock source to reduce system cost.

- Main Oscillator (MOSC):** The main oscillator provides a frequency-accurate clock source by one of two means: an external single-ended clock source is connected to the `OSC0` input pin, or an external crystal is connected across the `OSC0` input and `OSC1` output pins. The crystal value allowed depends on whether the main oscillator is used as the clock reference source to the PLL. If so, the crystal must be one of the supported frequencies between 3.579545 MHz through 8.192 MHz (inclusive). If the PLL is not being used, the crystal may be any one of the supported frequencies between 1 MHz and 8.192 MHz. The single-ended clock source range is from DC through the specified speed of the device. The supported crystals are listed in the `XTAL` bit field in the **RCC** register (see page 69).

The internal system clock (SysClk), is derived from any of the two sources plus two others: the output of the main internal PLL, and the internal oscillator divided by four (3 MHz \pm 30%). The frequency of the PLL clock reference must be in the range of 3.579545 MHz to 8.192 MHz (inclusive).

Nearly all of the control for the clocks is provided by the **Run-Mode Clock Configuration (RCC)** register.

Figure 6-2 on page 55 shows the logic for the main clock tree. The peripheral blocks are driven by the system clock signal and can be programmatically enabled/disabled. The ADC clock signal is automatically divided down to 16.67 MHz for proper ADC operation.

Figure 6-2. Main Clock Tree

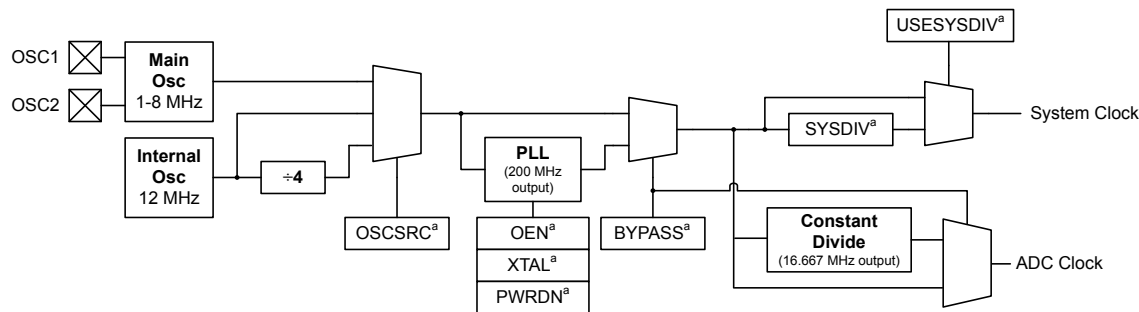

a. These are bit fields within the **Run-Mode Clock Configuration (RCC)** register.

6.1.4.2 Crystal Configuration for the Main Oscillator (MOSC)

The main oscillator supports the use of a select number of crystals. If the main oscillator is used by the PLL as a reference clock, the supported range of crystals is 3.579545 to 8.192 MHz, otherwise, the range of supported crystals is 1 to 8.192 MHz.

The `XTAL` bit in the **RCC** register (see page 69) describes the available crystal choices and default programming values.

Software configures the **RCC** register `XTAL` field with the crystal number. If the PLL is used in the design, the `XTAL` field value is internally translated to the PLL settings.

6.1.4.3 Main PLL Frequency Configuration

The main PLL is disabled by default during power-on reset and is enabled later by software if required. Software configures the main PLL input reference clock source, specifies the output divisor to set the system clock frequency, and enables the main PLL to drive the output.

If the main oscillator provides the clock reference to the main PLL, the translation provided by hardware and used to program the PLL is available for software in the **XTAL to PLL Translation (PLLCFG)** register (see page 73). The internal translation provides a translation within $\pm 1\%$ of the targeted PLL VCO frequency.

The Crystal Value field (*XTAL*) on page 69 describes the available crystal choices and default programming of the **PLLCFG** register. The crystal number is written into the *XTAL* field of the **Run-Mode Clock Configuration (RCC)** register. Any time the *XTAL* field changes, the new settings are translated and the internal PLL settings are updated.

6.1.4.4 PLL Modes

The PLL has two modes of operation: Normal and Power-Down

- Normal: The PLL multiplies the input clock reference and drives the output.
- Power-Down: Most of the PLL internal circuitry is disabled and the PLL does not drive the output.

The modes are programmed using the **RCC** register fields (see page 69).

6.1.4.5 PLL Operation

If a PLL configuration is changed, the PLL output frequency is unstable until it reconverges (relocks) to the new setting. The time between the configuration change and relock is T_{READY} (see Table 18-6 on page 376). During the relock time, the affected PLL is not usable as a clock reference.

The PLL is changed by one of the following:

- Change to the *XTAL* value in the **RCC** register—writes of the same value do not cause a relock.
- Change in the PLL from Power-Down to Normal mode.

A counter is defined to measure the T_{READY} requirement. The counter is clocked by the main oscillator. The range of the main oscillator has been taken into account and the down counter is set to 0x1200 (that is, $\sim 600 \mu\text{s}$ at an 8.192 MHz external oscillator clock). Hardware is provided to keep the PLL from being used as a system clock until the T_{READY} condition is met after one of the two changes above. It is the user's responsibility to have a stable clock source (like the main oscillator) before the **RCC** register is switched to use the PLL.

If the main PLL is enabled and the system clock is switched to use the PLL in one step, the system control hardware continues to clock the controller from the oscillator selected by the **RCC** register until the main PLL is stable (T_{READY} time met), after which it changes to the PLL. Software can use many methods to ensure that the system is clocked from the main PLL, including periodically polling the *PLLRRIS* bit in the **Raw Interrupt Status (RIS)** register, and enabling the PLL Lock interrupt.

6.1.4.6 Clock Verification Timers

There are three identical clock verification circuits that can be enabled through software. The circuit checks the faster clock by a slower clock using timers:

- The main oscillator checks the PLL.
- The main oscillator checks the internal oscillator.
- The internal oscillator divided by 64 checks the main oscillator.

If the verification timer function is enabled and a failure is detected, the main clock tree is immediately switched to a working clock and an interrupt is generated to the controller. Software can then determine the course of action to take. The actual failure indication and clock switching does not clear without a write to the **CLKVCLR** register, an external reset, or a POR reset. The clock verification timers are controlled by the **PLLVER**, **IOSCVER**, and **MOSCVER** bits in the **RCC** register.

6.1.5 System Control

For power-savings purposes, the **RCGCn**, **SCGCn**, and **DCGCn** registers control the clock gating logic for each peripheral or block in the system while the controller is in Run, Sleep, and Deep-Sleep mode, respectively. The **DC1**, **DC2** and **DC4** registers act as a write mask for the **RCGCn**, **SCGCn**, and **DCGCn** registers.

In Run mode, the controller is actively executing code. In Sleep mode, the clocking of the device is unchanged but the controller no longer executes code (and is no longer clocked). In Deep-Sleep mode, the clocking of the device may change (depending on the Run mode clock configuration) and the controller no longer executes code (and is no longer clocked). An interrupt returns the device to Run mode from one of the sleep modes. Each mode is described in more detail in this section.

There are four levels of operation for the device defined as:

- **Run Mode.** Run mode provides normal operation of the processor and all of the peripherals that are currently enabled by the **RCGCn** registers. The system clock can be any of the available clock sources including the PLL.
- **Sleep Mode.** Sleep mode is entered by the Cortex-M3 core executing a **WFI** (Wait for Interrupt) instruction. Any properly configured interrupt event in the system will bring the processor back into Run mode. See the system control NVIC section of the *ARM® Cortex™-M3 Technical Reference Manual* for more details.

In Sleep mode, the Cortex-M3 processor core and the memory subsystem are not clocked. Peripherals are clocked that are enabled in the **SCGCn** register when auto-clock gating is enabled (see the **RCC** register) or the **RCGCn** register when the auto-clock gating is disabled. The system clock has the same source and frequency as that during Run mode.

- **Deep-Sleep Mode.** Deep-Sleep mode is entered by first writing the Deep Sleep Enable bit in the ARM Cortex-M3 NVIC system control register and then executing a **WFI** instruction. Any properly configured interrupt event in the system will bring the processor back into Run mode. See the system control NVIC section of the *ARM® Cortex™-M3 Technical Reference Manual* for more details.

The Cortex-M3 processor core and the memory subsystem are not clocked. Peripherals are clocked that are enabled in the **DCGCn** register when auto-clock gating is enabled (see the **RCC** register) or the **RCGCn** register when auto-clock gating is disabled. The system clock source is the main oscillator by default or the internal oscillator specified in the **DSLPCCLKCFG** register if one is enabled. When the **DSLPCCLKCFG** register is used, the internal oscillator is powered up, if necessary, and the main oscillator is powered down. If the PLL is running at the time of the **WFI** instruction, hardware will power the PLL down and override the **SYSDIV** field of the active **RCC** register to be /16 or /64, respectively. When the Deep-Sleep exit event occurs, hardware brings the system clock back to the source and frequency it had at the onset of Deep-Sleep mode before enabling the clocks that had been stopped during the Deep-Sleep duration.

6.2 Initialization and Configuration

The PLL is configured using direct register writes to the **RCC** register. The steps required to successfully change the PLL-based system clock are:

1. Bypass the PLL and system clock divider by setting the **BYPASS** bit and clearing the **USESYS** bit in the **RCC** register. This configures the system to run off a “raw” clock source (using the main oscillator or internal oscillator) and allows for the new PLL configuration to be validated before switching the system clock to the PLL.
2. Select the crystal value (**XTAL**) and oscillator source (**OSCSRC**), and clear the **PWRDN** and **OEN** bits in **RCC**. Setting the **XTAL** field automatically pulls valid PLL configuration data for the appropriate crystal, and clearing the **PWRDN** and **OEN** bits powers and enables the PLL and its output.
3. Select the desired system divider (**SYSDIV**) in **RCC** and set the **USESYS** bit in **RCC**. The **SYSDIV** field determines the system frequency for the microcontroller.
4. Wait for the PLL to lock by polling the **PLLLRIS** bit in the **Raw Interrupt Status (RIS)** register.
5. Enable use of the PLL by clearing the **BYPASS** bit in **RCC**.

Note: If the **BYPASS** bit is cleared before the PLL locks, it is possible to render the device unusable.

6.3 Register Map

Table 6-1 on page 58 lists the System Control registers, grouped by function. The offset listed is a hexadecimal increment to the register’s address, relative to the System Control base address of 0x400F.E000.

Note: Spaces in the System Control register space that are not used are reserved for future or internal use by Luminary Micro, Inc. Software should not modify any reserved memory address.

Table 6-1. System Control Register Map

Offset	Name	Type	Reset	Description	See page
0x000	DID0	RO	-	Device Identification 0	60
0x004	DID1	RO	-	Device Identification 1	77
0x008	DC0	RO	0x001F.001F	Device Capabilities 0	79
0x010	DC1	RO	0x0001.33BF	Device Capabilities 1	80
0x014	DC2	RO	0x0007.1013	Device Capabilities 2	82
0x018	DC3	RO	0xBFFF.0000	Device Capabilities 3	84
0x01C	DC4	RO	0x0000.001F	Device Capabilities 4	86
0x030	PBORCTL	R/W	0x0000.7FFD	Power-On and Brown-Out Reset Control	62
0x034	LDOPCTL	R/W	0x0000.0000	LDO Power Control	63
0x040	SRCR0	R/W	0x00000000	Software Reset Control 0	105
0x044	SRCR1	R/W	0x00000000	Software Reset Control 1	106

Offset	Name	Type	Reset	Description	See page
0x048	SRCR2	R/W	0x00000000	Software Reset Control 2	107
0x050	RIS	RO	0x0000.0000	Raw Interrupt Status	64
0x054	IMC	R/W	0x0000.0000	Interrupt Mask Control	65
0x058	MISC	R/W1C	0x0000.0000	Masked Interrupt Status and Clear	67
0x05C	RESC	R/W	-	Reset Cause	68
0x060	RCC	R/W	0x0780.3AC0	Run-Mode Clock Configuration	69
0x064	PLLCFG	RO	-	XTAL to PLL Translation	73
0x100	RCGC0	R/W	0x00000040	Run Mode Clock Gating Control Register 0	87
0x104	RCGC1	R/W	0x00000000	Run Mode Clock Gating Control Register 1	93
0x108	RCGC2	R/W	0x00000000	Run Mode Clock Gating Control Register 2	99
0x110	SCGC0	R/W	0x00000040	Sleep Mode Clock Gating Control Register 0	89
0x114	SCGC1	R/W	0x00000000	Sleep Mode Clock Gating Control Register 1	95
0x118	SCGC2	R/W	0x00000000	Sleep Mode Clock Gating Control Register 2	101
0x120	DCGC0	R/W	0x00000040	Deep Sleep Mode Clock Gating Control Register 0	91
0x124	DCGC1	R/W	0x00000000	Deep Sleep Mode Clock Gating Control Register 1	97
0x128	DCGC2	R/W	0x00000000	Deep Sleep Mode Clock Gating Control Register 2	103
0x144	DSLPCCLKCFG	R/W	0x0780.0000	Deep Sleep Clock Configuration	74
0x150	CLKVCLR	R/W	0x0000.0000	Clock Verification Clear	75
0x160	LDOARST	R/W	0x0000.0000	Allow Unregulated LDO to Reset the Part	76

6.4 Register Descriptions

All addresses given are relative to the System Control base address of 0x400F.E000.

Register 1: Device Identification 0 (DID0), offset 0x000

This register identifies the version of the device.

Device Identification 0 (DID0)

Base 0x400F.E000

Offset 0x000

Type RO, reset -

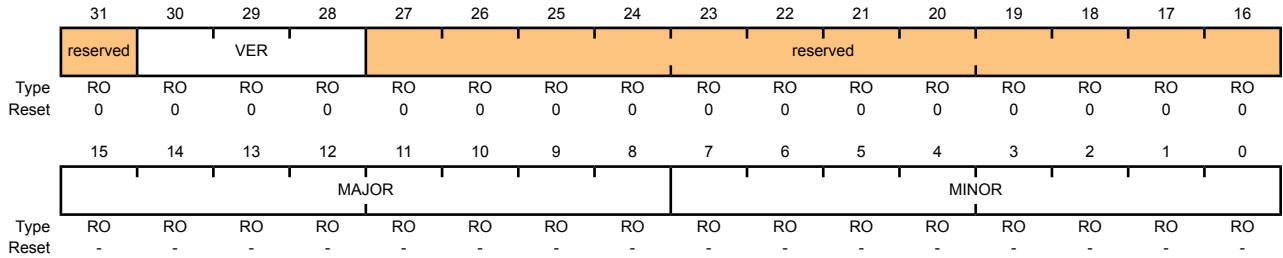

Bit/Field	Name	Type	Reset	Description								
31	reserved	RO	0	Software should not rely on the value of a reserved bit. To provide compatibility with future products, the value of a reserved bit should be preserved across a read-modify-write operation.								
30:28	VER	RO	0x0	<p>DID0 Version</p> <p>This field defines the DID0 register format version. The version number is numeric. The value of the <code>VER</code> field is encoded as follows:</p> <table border="1"> <thead> <tr> <th>Value</th> <th>Description</th> </tr> </thead> <tbody> <tr> <td>0x0</td> <td>Initial DID0 register format definition for Stellaris® Sandstorm-class devices.</td> </tr> </tbody> </table>	Value	Description	0x0	Initial DID0 register format definition for Stellaris® Sandstorm-class devices.				
Value	Description											
0x0	Initial DID0 register format definition for Stellaris® Sandstorm-class devices.											
27:16	reserved	RO	0x0	Software should not rely on the value of a reserved bit. To provide compatibility with future products, the value of a reserved bit should be preserved across a read-modify-write operation.								
15:8	MAJOR	RO	-	<p>Major Revision</p> <p>This field specifies the major revision number of the device. The major revision reflects changes to base layers of the design. The major revision number is indicated in the part number as a letter (A for first revision, B for second, and so on). This field is encoded as follows:</p> <table border="1"> <thead> <tr> <th>Value</th> <th>Description</th> </tr> </thead> <tbody> <tr> <td>0x0</td> <td>Revision A (initial device)</td> </tr> <tr> <td>0x1</td> <td>Revision B (first base layer revision)</td> </tr> <tr> <td>0x2</td> <td>Revision C (second base layer revision)</td> </tr> </tbody> </table> <p>and so on.</p>	Value	Description	0x0	Revision A (initial device)	0x1	Revision B (first base layer revision)	0x2	Revision C (second base layer revision)
Value	Description											
0x0	Revision A (initial device)											
0x1	Revision B (first base layer revision)											
0x2	Revision C (second base layer revision)											

Bit/Field	Name	Type	Reset	Description								
7:0	MINOR	RO	-	<p>Minor Revision</p> <p>This field specifies the minor revision number of the device. The minor revision reflects changes to the metal layers of the design. The <code>MINOR</code> field value is reset when the <code>MAJOR</code> field is changed. This field is numeric and is encoded as follows:</p> <table><thead><tr><th>Value</th><th>Description</th></tr></thead><tbody><tr><td>0x0</td><td>Initial device, or a major revision update.</td></tr><tr><td>0x1</td><td>First metal layer change.</td></tr><tr><td>0x2</td><td>Second metal layer change.</td></tr></tbody></table> <p>and so on.</p>	Value	Description	0x0	Initial device, or a major revision update.	0x1	First metal layer change.	0x2	Second metal layer change.
Value	Description											
0x0	Initial device, or a major revision update.											
0x1	First metal layer change.											
0x2	Second metal layer change.											

Register 2: Power-On and Brown-Out Reset Control (PBORCTL), offset 0x030

This register is responsible for controlling reset conditions after initial power-on reset.

Power-On and Brown-Out Reset Control (PBORCTL)

Base 0x400F.E000

Offset 0x030

Type R/W, reset 0x0000.7FFD

	31	30	29	28	27	26	25	24	23	22	21	20	19	18	17	16
	reserved															
Type	RO	RO	RO	RO	RO	RO	RO	RO	RO	RO	RO	RO	RO	RO	RO	RO
Reset	0	0	0	0	0	0	0	0	0	0	0	0	0	0	0	0
	15	14	13	12	11	10	9	8	7	6	5	4	3	2	1	0
	BORTIM														BORIOR	BORWT
Type	R/W	R/W	R/W	R/W	R/W	R/W	R/W	R/W	R/W	R/W	R/W	R/W	R/W	R/W	R/W	R/W
Reset	0	1	1	1	1	1	1	1	1	1	1	1	1	1	0	1

Bit/Field	Name	Type	Reset	Description
31:16	reserved	RO	0x0	Software should not rely on the value of a reserved bit. To provide compatibility with future products, the value of a reserved bit should be preserved across a read-modify-write operation.
15:2	BORTIM	R/W	0x1FFF	<p>BOR Time Delay</p> <p>This field specifies the number of internal oscillator clocks delayed before the BOR output is resampled if the BORWT bit is set.</p> <p>The width of this field is derived by the t_{BOR} width of 500 μs and the internal oscillator (IOSC) frequency of 12 MHz \pm 30%. At +30%, the counter value has to exceed 7,800.</p>
1	BORIOR	R/W	0	<p>BOR Interrupt or Reset</p> <p>This bit controls how a BOR event is signaled to the controller. If set, a reset is signaled. Otherwise, an interrupt is signaled.</p>
0	BORWT	R/W	1	<p>BOR Wait and Check for Noise</p> <p>This bit specifies the response to a brown-out signal assertion if BORIOR is not set.</p> <p>If BORWT is set to 1 and BORIOR is cleared to 0, the controller waits BORTIM IOSC periods and resamples the BOR output. If still asserted, a BOR interrupt is signalled. If no longer asserted, the initial assertion is suppressed (attributable to noise).</p> <p>If BORWT is 0, BOR assertions do not resample the output and any condition is reported immediately if enabled.</p>

Register 3: LDO Power Control (LDOPCTL), offset 0x034

The V_{ADJ} field in this register adjusts the on-chip output voltage (V_{OUT}).

LDO Power Control (LDOPCTL)

Base 0x400F.E000

Offset 0x034

Type R/W, reset 0x0000.0000

	31	30	29	28	27	26	25	24	23	22	21	20	19	18	17	16
	reserved															
Type	RO	RO	RO	RO	RO	RO	RO	RO	RO	RO	RO	RO	RO	RO	RO	RO
Reset	0	0	0	0	0	0	0	0	0	0	0	0	0	0	0	0
	15	14	13	12	11	10	9	8	7	6	5	4	3	2	1	0
	reserved										V_{ADJ}					
Type	RO	RO	RO	RO	RO	RO	RO	RO	RO	RO	R/W	R/W	R/W	R/W	R/W	R/W
Reset	0	0	0	0	0	0	0	0	0	0	0	0	0	0	0	0

Bit/Field	Name	Type	Reset	Description
31:6	reserved	RO	0	Software should not rely on the value of a reserved bit. To provide compatibility with future products, the value of a reserved bit should be preserved across a read-modify-write operation.

Bit/Field	Name	Type	Reset	Description
5:0	V_{ADJ}	R/W	0x0	LDO Output Voltage

This field sets the on-chip output voltage. The programming values for the V_{ADJ} field are provided below.

Value	V_{OUT} (V)
0x00	2.50
0x01	2.45
0x02	2.40
0x03	2.35
0x04	2.30
0x05	2.25
0x06-0x3F	Reserved
0x1B	2.75
0x1C	2.70
0x1D	2.65
0x1E	2.60
0x1F	2.55

Register 4: Raw Interrupt Status (RIS), offset 0x050

Central location for system control raw interrupts. These are set and cleared by hardware.

Raw Interrupt Status (RIS)

Base 0x400F.E000

Offset 0x050

Type RO, reset 0x0000.0000

	31	30	29	28	27	26	25	24	23	22	21	20	19	18	17	16	
	reserved																
Type	RO	RO	RO	RO	RO	RO	RO	RO	RO	RO	RO	RO	RO	RO	RO	RO	
Reset	0	0	0	0	0	0	0	0	0	0	0	0	0	0	0	0	
	15	14	13	12	11	10	9	8	7	6	5	4	3	2	1	0	
	reserved										PLLLRIS	CLRIS	IOFRIS	MOFRIS	LDORIS	BORRIS	PLLFris
Type	RO	RO	RO	RO	RO	RO	RO	RO	RO	RO	RO	RO	RO	RO	RO	RO	
Reset	0	0	0	0	0	0	0	0	0	0	0	0	0	0	0	0	

Bit/Field	Name	Type	Reset	Description
31:7	reserved	RO	0	Software should not rely on the value of a reserved bit. To provide compatibility with future products, the value of a reserved bit should be preserved across a read-modify-write operation.
6	PLLLRIS	RO	0	PLL Lock Raw Interrupt Status This bit is set when the PLL T _{READY} Timer asserts.
5	CLRIS	RO	0	Current Limit Raw Interrupt Status This bit is set if the LDO's CLE output asserts.
4	IOFRIS	RO	0	Internal Oscillator Fault Raw Interrupt Status This bit is set if an internal oscillator fault is detected.
3	MOFRIS	RO	0	Main Oscillator Fault Raw Interrupt Status This bit is set if a main oscillator fault is detected.
2	LDORIS	RO	0	LDO Power Unregulated Raw Interrupt Status This bit is set if a LDO voltage is unregulated.
1	BORRIS	RO	0	Brown-Out Reset Raw Interrupt Status This bit is the raw interrupt status for any brown-out conditions. If set, a brown-out condition is currently active. This is an unregistered signal from the brown-out detection circuit. An interrupt is reported if the BOR _{IM} bit in the IMC register is set and the BOR _{IOR} bit in the PBORCTL register is cleared.
0	PLLFris	RO	0	PLL Fault Raw Interrupt Status This bit is set if a PLL fault is detected (stops oscillating).

Register 5: Interrupt Mask Control (IMC), offset 0x054

Central location for system control interrupt masks.

Interrupt Mask Control (IMC)

Base 0x400F.E000
Offset 0x054
Type R/W, reset 0x0000.0000

	31	30	29	28	27	26	25	24	23	22	21	20	19	18	17	16		
	reserved																	
Type	RO	RO	RO	RO	RO	RO	RO	RO	RO	RO	RO	RO	RO	RO	RO	RO		
Reset	0	0	0	0	0	0	0	0	0	0	0	0	0	0	0	0		
	15	14	13	12	11	10	9	8	7	6	5	4	3	2	1	0		
	reserved											PLLLIM	CLIM	IOFIM	MOFIM	LDOIM	BORIM	PLLFIM
Type	RO	RO	RO	RO	RO	RO	RO	RO	RO	RO	R/W	R/W	R/W	R/W	R/W	R/W		
Reset	0	0	0	0	0	0	0	0	0	0	0	0	0	0	0	0		

Bit/Field	Name	Type	Reset	Description
31:7	reserved	RO	0	Software should not rely on the value of a reserved bit. To provide compatibility with future products, the value of a reserved bit should be preserved across a read-modify-write operation.
6	PLLLIM	R/W	0	<p>PLL Lock Interrupt Mask</p> <p>This bit specifies whether a current limit detection is promoted to a controller interrupt. If set, an interrupt is generated if <code>PLLLRIS</code> in RIS is set; otherwise, an interrupt is not generated.</p>
5	CLIM	R/W	0	<p>Current Limit Interrupt Mask</p> <p>This bit specifies whether a current limit detection is promoted to a controller interrupt. If set, an interrupt is generated if <code>CLRIS</code> is set; otherwise, an interrupt is not generated.</p>
4	IOFIM	R/W	0	<p>Internal Oscillator Fault Interrupt Mask</p> <p>This bit specifies whether an internal oscillator fault detection is promoted to a controller interrupt. If set, an interrupt is generated if <code>IOFRIS</code> is set; otherwise, an interrupt is not generated.</p>
3	MOFIM	R/W	0	<p>Main Oscillator Fault Interrupt Mask</p> <p>This bit specifies whether a main oscillator fault detection is promoted to a controller interrupt. If set, an interrupt is generated if <code>MOFRIS</code> is set; otherwise, an interrupt is not generated.</p>
2	LDOIM	R/W	0	<p>LDO Power Unregulated Interrupt Mask</p> <p>This bit specifies whether an LDO unregulated power situation is promoted to a controller interrupt. If set, an interrupt is generated if <code>LDORIS</code> is set; otherwise, an interrupt is not generated.</p>
1	BORIM	R/W	0	<p>Brown-Out Reset Interrupt Mask</p> <p>This bit specifies whether a brown-out condition is promoted to a controller interrupt. If set, an interrupt is generated if <code>BORRIS</code> is set; otherwise, an interrupt is not generated.</p>

Bit/Field	Name	Type	Reset	Description
0	PLL FIM	R/W	0	PLL Fault Interrupt Mask This bit specifies whether a PLL fault detection is promoted to a controller interrupt. If set, an interrupt is generated if <code>PLLFRIS</code> is set; otherwise, an interrupt is not generated.

Register 6: Masked Interrupt Status and Clear (MISC), offset 0x058

On a read, this register gives the current masked status value of the corresponding interrupt. All of the bits are R/W1C and this action also clears the corresponding raw interrupt bit in the **RIS** register (see page 64).

Masked Interrupt Status and Clear (MISC)

Base 0x400F.E000

Offset 0x058

Type R/W1C, reset 0x0000.0000

	31	30	29	28	27	26	25	24	23	22	21	20	19	18	17	16	
	reserved																
Type	RO	RO	RO	RO	RO	RO	RO	RO	RO	RO	RO	RO	RO	RO	RO	RO	
Reset	0	0	0	0	0	0	0	0	0	0	0	0	0	0	0	0	
	15	14	13	12	11	10	9	8	7	6	5	4	3	2	1	0	
	reserved										PLLLMIS	CLMIS	IOFMIS	MOFMIS	LDMIS	BORMIS	reserved
Type	RO	RO	RO	RO	RO	RO	RO	RO	RO	RO	R/W1C	R/W1C	R/W1C	R/W1C	R/W1C	R/W1C	RO
Reset	0	0	0	0	0	0	0	0	0	0	0	0	0	0	0	0	0

Bit/Field	Name	Type	Reset	Description
31:7	reserved	RO	0	Software should not rely on the value of a reserved bit. To provide compatibility with future products, the value of a reserved bit should be preserved across a read-modify-write operation.
6	PLLLMIS	R/W1C	0	PLL Lock Masked Interrupt Status This bit is set when the PLL T _{READY} timer asserts. The interrupt is cleared by writing a 1 to this bit.
5	CLMIS	R/W1C	0	Current Limit Masked Interrupt Status This bit is set if the LDO's CLE output asserts. The interrupt is cleared by writing a 1 to this bit.
4	IOFMIS	R/W1C	0	Internal Oscillator Fault Masked Interrupt Status This bit is set if an internal oscillator fault is detected. The interrupt is cleared by writing a 1 to this bit.
3	MOFMIS	R/W1C	0	Main Oscillator Fault Masked Interrupt Status This bit is set if a main oscillator fault is detected. The interrupt is cleared by writing a 1 to this bit.
2	LDMIS	R/W1C	0	LDO Power Unregulated Masked Interrupt Status This bit is set if LDO power is unregulated. The interrupt is cleared by writing a 1 to this bit.
1	BORMIS	R/W1C	0	BOR Masked Interrupt Status This bit is the masked interrupt status for any brown-out conditions. If set, a brown-out condition was detected. An interrupt is reported if the BOR _{IM} bit in the IMC register is set and the BOR _{IOR} bit in the PBORCTL register is cleared. The interrupt is cleared by writing a 1 to this bit.
0	reserved	RO	0	Software should not rely on the value of a reserved bit. To provide compatibility with future products, the value of a reserved bit should be preserved across a read-modify-write operation.

Register 7: Reset Cause (RESC), offset 0x05C

This field specifies the cause of the reset event to software. The reset value is determined by the cause of the reset. When an external reset is the cause (`EXT` is set), all other reset bits are cleared. However, if the reset is due to any other cause, the remaining bits are sticky, allowing software to see all causes.

Reset Cause (RESC)

Base 0x400F.E000

Offset 0x05C

Type R/W, reset -

	31	30	29	28	27	26	25	24	23	22	21	20	19	18	17	16	
	reserved																
Type	RO	RO	RO	RO	RO	RO	RO	RO	RO	RO	RO	RO	RO	RO	RO	RO	
Reset	0	0	0	0	0	0	0	0	0	0	0	0	0	0	0	0	
	15	14	13	12	11	10	9	8	7	6	5	4	3	2	1	0	
	reserved											LDO	SW	WDT	BOR	POR	EXT
Type	RO	RO	RO	RO	RO	RO	RO	RO	RO	RO	R/W	R/W	R/W	R/W	R/W	R/W	
Reset	0	0	0	0	0	0	0	0	0	0	-	-	-	-	-	-	

Bit/Field	Name	Type	Reset	Description
31:6	reserved	RO	0	Software should not rely on the value of a reserved bit. To provide compatibility with future products, the value of a reserved bit should be preserved across a read-modify-write operation.
5	LDO	R/W	-	LDO Reset When set, indicates the LDO circuit has lost regulation and has generated a reset event.
4	SW	R/W	-	Software Reset When set, indicates a software reset is the cause of the reset event.
3	WDT	R/W	-	Watchdog Timer Reset When set, indicates a watchdog reset is the cause of the reset event.
2	BOR	R/W	-	Brown-Out Reset When set, indicates a brown-out reset is the cause of the reset event.
1	POR	R/W	-	Power-On Reset When set, indicates a power-on reset is the cause of the reset event.
0	EXT	R/W	-	External Reset When set, indicates an external reset (\overline{RST} assertion) is the cause of the reset event.

Register 8: Run-Mode Clock Configuration (RCC), offset 0x060

This register is defined to provide source control and frequency speed.

Run-Mode Clock Configuration (RCC)

Base 0x400F.E000
Offset 0x060
Type R/W, reset 0x0780.3AC0

	31	30	29	28	27	26	25	24	23	22	21	20	19	18	17	16
	reserved				ACG	SYSDIV					USESYS DIV	reserved				
Type	RO	RO	RO	RO	R/W	R/W	R/W	R/W	R/W	R/W	RO	RO	RO	RO	RO	RO
Reset	0	0	0	0	0	1	1	1	1	0	0	0	0	0	0	0
	15	14	13	12	11	10	9	8	7	6	5	4	3	2	1	0
	reserved		PWRDN	OEN	BYPASS	PLLVER	XTAL				OSCSRC		IOSCOVER	MOSCOVER	IOSCDIS	MOSCDIS
Type	RO	RO	R/W	R/W	R/W	R/W	R/W	R/W	R/W	R/W	R/W	R/W	R/W	R/W	R/W	R/W
Reset	0	0	1	1	1	0	1	0	1	1	0	0	0	0	0	0

Bit/Field	Name	Type	Reset	Description
31:28	reserved	RO	0x0	Software should not rely on the value of a reserved bit. To provide compatibility with future products, the value of a reserved bit should be preserved across a read-modify-write operation.
27	ACG	R/W	0	<p>Auto Clock Gating</p> <p>This bit specifies whether the system uses the Sleep-Mode Clock Gating Control (SCGCn) registers and Deep-Sleep-Mode Clock Gating Control (DCGCn) registers if the controller enters a Sleep or Deep-Sleep mode (respectively). If set, the SCGCn or DCGCn registers are used to control the clocks distributed to the peripherals when the controller is in a sleep mode. Otherwise, the Run-Mode Clock Gating Control (RCGCn) registers are used when the controller enters a sleep mode.</p> <p>The RCGCn registers are always used to control the clocks in Run mode.</p> <p>This allows peripherals to consume less power when the controller is in a sleep mode and the peripheral is unused.</p>

Bit/Field	Name	Type	Reset	Description																																																			
26:23	SYSDIV	R/W	0xF	<p>System Clock Divisor</p> <p>Specifies which divisor is used to generate the system clock from the PLL output.</p> <p>The PLL VCO frequency is 200 MHz.</p> <table border="1"> <thead> <tr> <th>Value</th> <th>Divisor (BYPASS=1)</th> <th>Frequency (BYPASS=0)</th> </tr> </thead> <tbody> <tr><td>0x0</td><td>reserved</td><td>reserved</td></tr> <tr><td>0x1</td><td>/2</td><td>reserved</td></tr> <tr><td>0x2</td><td>/3</td><td>reserved</td></tr> <tr><td>0x3</td><td>/4</td><td>50 MHz</td></tr> <tr><td>0x4</td><td>/5</td><td>40 MHz</td></tr> <tr><td>0x5</td><td>/6</td><td>33.33 MHz</td></tr> <tr><td>0x6</td><td>/7</td><td>28.57 MHz</td></tr> <tr><td>0x7</td><td>/8</td><td>25 MHz</td></tr> <tr><td>0x8</td><td>/9</td><td>22.22 MHz</td></tr> <tr><td>0x9</td><td>/10</td><td>20 MHz</td></tr> <tr><td>0xA</td><td>/11</td><td>18.18 MHz</td></tr> <tr><td>0xB</td><td>/12</td><td>16.67 MHz</td></tr> <tr><td>0xC</td><td>/13</td><td>15.38 MHz</td></tr> <tr><td>0xD</td><td>/14</td><td>14.29 MHz</td></tr> <tr><td>0xE</td><td>/15</td><td>13.33 MHz</td></tr> <tr><td>0xF</td><td>/16</td><td>12.5 MHz (default)</td></tr> </tbody> </table> <p>When reading the Run-Mode Clock Configuration (RCC) register (see page 69), the SYSDIV value is MINSYSDIV if a lower divider was requested and the PLL is being used. This lower value is allowed to divide a non-PLL source.</p>	Value	Divisor (BYPASS=1)	Frequency (BYPASS=0)	0x0	reserved	reserved	0x1	/2	reserved	0x2	/3	reserved	0x3	/4	50 MHz	0x4	/5	40 MHz	0x5	/6	33.33 MHz	0x6	/7	28.57 MHz	0x7	/8	25 MHz	0x8	/9	22.22 MHz	0x9	/10	20 MHz	0xA	/11	18.18 MHz	0xB	/12	16.67 MHz	0xC	/13	15.38 MHz	0xD	/14	14.29 MHz	0xE	/15	13.33 MHz	0xF	/16	12.5 MHz (default)
Value	Divisor (BYPASS=1)	Frequency (BYPASS=0)																																																					
0x0	reserved	reserved																																																					
0x1	/2	reserved																																																					
0x2	/3	reserved																																																					
0x3	/4	50 MHz																																																					
0x4	/5	40 MHz																																																					
0x5	/6	33.33 MHz																																																					
0x6	/7	28.57 MHz																																																					
0x7	/8	25 MHz																																																					
0x8	/9	22.22 MHz																																																					
0x9	/10	20 MHz																																																					
0xA	/11	18.18 MHz																																																					
0xB	/12	16.67 MHz																																																					
0xC	/13	15.38 MHz																																																					
0xD	/14	14.29 MHz																																																					
0xE	/15	13.33 MHz																																																					
0xF	/16	12.5 MHz (default)																																																					
22	USESYSCLK	R/W	0	<p>Enable System Clock Divider</p> <p>Use the system clock divider as the source for the system clock. The system clock divider is forced to be used when the PLL is selected as the source.</p>																																																			
21:14	reserved	RO	0	<p>Software should not rely on the value of a reserved bit. To provide compatibility with future products, the value of a reserved bit should be preserved across a read-modify-write operation.</p>																																																			
13	PWRDN	R/W	1	<p>PLL Power Down</p> <p>This bit connects to the PLL PWRDN input. The reset value of 1 powers down the PLL. See Table 6-2 on page 72 for PLL mode control.</p>																																																			
12	OEN	R/W	1	<p>PLL Output Enable</p> <p>This bit specifies whether the PLL output driver is enabled. If cleared, the driver transmits the PLL clock to the output. Otherwise, the PLL clock does not oscillate outside the PLL module.</p> <p>Note: Both PWRDN and OEN must be cleared to run the PLL.</p>																																																			

Bit/Field	Name	Type	Reset	Description																																																			
11	BYPASS	R/W	1	<p>PLL Bypass</p> <p>Chooses whether the system clock is derived from the PLL output or the OSC source. If set, the clock that drives the system is the OSC source. Otherwise, the clock that drives the system is the PLL output clock divided by the system divider.</p> <p>Note: The ADC must be clocked from the PLL or directly from a 14-MHz to 18-MHz clock source to operate properly.</p>																																																			
10	PLLVER	R/W	0	<p>PLL Verification</p> <p>This bit controls the PLL verification timer function. If set, the verification timer is enabled and an interrupt is generated if the PLL becomes inoperative. Otherwise, the verification timer is not enabled.</p>																																																			
9:6	XTAL	R/W	0xB	<p>Crystal Value</p> <p>This field specifies the crystal value attached to the main oscillator. The encoding for this field is provided below.</p> <table border="1"> <thead> <tr> <th>Value</th> <th>Crystal Frequency (MHz) Not Using the PLL</th> <th>Crystal Frequency (MHz) Using the PLL</th> </tr> </thead> <tbody> <tr><td>0x0</td><td>1.000</td><td>reserved</td></tr> <tr><td>0x1</td><td>1.8432</td><td>reserved</td></tr> <tr><td>0x2</td><td>2.000</td><td>reserved</td></tr> <tr><td>0x3</td><td>2.4576</td><td>reserved</td></tr> <tr><td>0x4</td><td></td><td>3.579545 MHz</td></tr> <tr><td>0x5</td><td></td><td>3.6864 MHz</td></tr> <tr><td>0x6</td><td></td><td>4 MHz</td></tr> <tr><td>0x7</td><td></td><td>4.096 MHz</td></tr> <tr><td>0x8</td><td></td><td>4.9152 MHz</td></tr> <tr><td>0x9</td><td></td><td>5 MHz</td></tr> <tr><td>0xA</td><td></td><td>5.12 MHz</td></tr> <tr><td>0xB</td><td></td><td>6 MHz (reset value)</td></tr> <tr><td>0xC</td><td></td><td>6.144 MHz</td></tr> <tr><td>0xD</td><td></td><td>7.3728 MHz</td></tr> <tr><td>0xE</td><td></td><td>8 MHz</td></tr> <tr><td>0xF</td><td></td><td>8.192 MHz</td></tr> </tbody> </table>	Value	Crystal Frequency (MHz) Not Using the PLL	Crystal Frequency (MHz) Using the PLL	0x0	1.000	reserved	0x1	1.8432	reserved	0x2	2.000	reserved	0x3	2.4576	reserved	0x4		3.579545 MHz	0x5		3.6864 MHz	0x6		4 MHz	0x7		4.096 MHz	0x8		4.9152 MHz	0x9		5 MHz	0xA		5.12 MHz	0xB		6 MHz (reset value)	0xC		6.144 MHz	0xD		7.3728 MHz	0xE		8 MHz	0xF		8.192 MHz
Value	Crystal Frequency (MHz) Not Using the PLL	Crystal Frequency (MHz) Using the PLL																																																					
0x0	1.000	reserved																																																					
0x1	1.8432	reserved																																																					
0x2	2.000	reserved																																																					
0x3	2.4576	reserved																																																					
0x4		3.579545 MHz																																																					
0x5		3.6864 MHz																																																					
0x6		4 MHz																																																					
0x7		4.096 MHz																																																					
0x8		4.9152 MHz																																																					
0x9		5 MHz																																																					
0xA		5.12 MHz																																																					
0xB		6 MHz (reset value)																																																					
0xC		6.144 MHz																																																					
0xD		7.3728 MHz																																																					
0xE		8 MHz																																																					
0xF		8.192 MHz																																																					
5:4	OSCSRC	R/W	0x0	<p>Oscillator Source</p> <p>Picks among the four input sources for the OSC. The values are:</p> <table border="1"> <thead> <tr> <th>Value</th> <th>Input Source</th> </tr> </thead> <tbody> <tr><td>0x0</td><td>Main oscillator (default)</td></tr> <tr><td>0x1</td><td>Internal oscillator</td></tr> <tr><td>0x2</td><td>Internal oscillator / 4 (this is necessary if used as input to PLL)</td></tr> <tr><td>0x3</td><td>reserved</td></tr> </tbody> </table>	Value	Input Source	0x0	Main oscillator (default)	0x1	Internal oscillator	0x2	Internal oscillator / 4 (this is necessary if used as input to PLL)	0x3	reserved																																									
Value	Input Source																																																						
0x0	Main oscillator (default)																																																						
0x1	Internal oscillator																																																						
0x2	Internal oscillator / 4 (this is necessary if used as input to PLL)																																																						
0x3	reserved																																																						

Bit/Field	Name	Type	Reset	Description
3	IOSCVR	R/W	0	Internal Oscillator Verification Timer This bit controls the internal oscillator verification timer function. If set, the verification timer is enabled and an interrupt is generated if the timer becomes inoperative. Otherwise, the verification timer is not enabled.
2	MOSCVR	R/W	0	Main Oscillator Verification Timer This bit controls the main oscillator verification timer function. If set, the verification timer is enabled and an interrupt is generated if the timer becomes inoperative. Otherwise, the verification timer is not enabled.
1	IOSCDIS	R/W	0	Internal Oscillator Disable 0: Internal oscillator (IOSC) is enabled. 1: Internal oscillator is disabled.
0	MOSCDIS	R/W	0	Main Oscillator Disable 0: Main oscillator is enabled (default). 1: Main oscillator is disabled .

Table 6-2. PLL Mode Control

PWRDN	OEN	Mode
1	X	Power down
0	0	Normal

Register 9: XTAL to PLL Translation (PLLCFG), offset 0x064

This register provides a means of translating external crystal frequencies into the appropriate PLL settings. This register is initialized during the reset sequence and updated anytime that the XTAL field changes in the Run-Mode Clock Configuration (RCC) register (see page 69).

The PLL frequency is calculated using the PLLCFG field values, as follows:

$$PLLFreq = OSCFreq * (F + 2) / (R + 2)$$

XTAL to PLL Translation (PLLCFG)

Base 0x400F.E000

Offset 0x064

Type RO, reset -

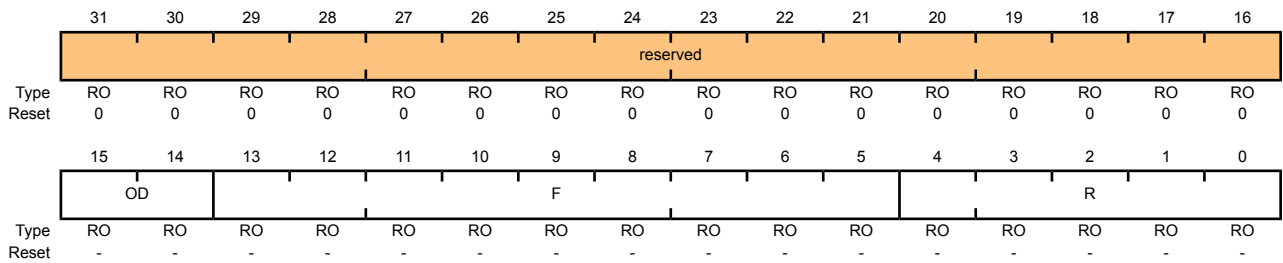

Bit/Field	Name	Type	Reset	Description
31:16	reserved	RO	0x0	Software should not rely on the value of a reserved bit. To provide compatibility with future products, the value of a reserved bit should be preserved across a read-modify-write operation.
15:14	OD	RO	-	PLL OD Value This field specifies the value supplied to the PLL's OD input. Value Description 0x0 Divide by 1 0x1 Divide by 2 0x2 Divide by 4 0x3 Reserved
13:5	F	RO	-	PLL F Value This field specifies the value supplied to the PLL's F input.
4:0	R	RO	-	PLL R Value This field specifies the value supplied to the PLL's R input.

Register 10: Deep Sleep Clock Configuration (DSLPCCLKCFG), offset 0x144

This register is used to automatically switch from the main oscillator to the internal oscillator when entering Deep-Sleep mode. The system clock source is the main oscillator by default. When this register is set, the internal oscillator is powered up and the main oscillator is powered down. When the Deep-Sleep exit event occurs, hardware brings the system clock back to the source and frequency it had at the onset of Deep-Sleep mode.

Deep Sleep Clock Configuration (DSLPCCLKCFG)

Base 0x400F.E000
 Offset 0x144
 Type R/W, reset 0x0780.0000

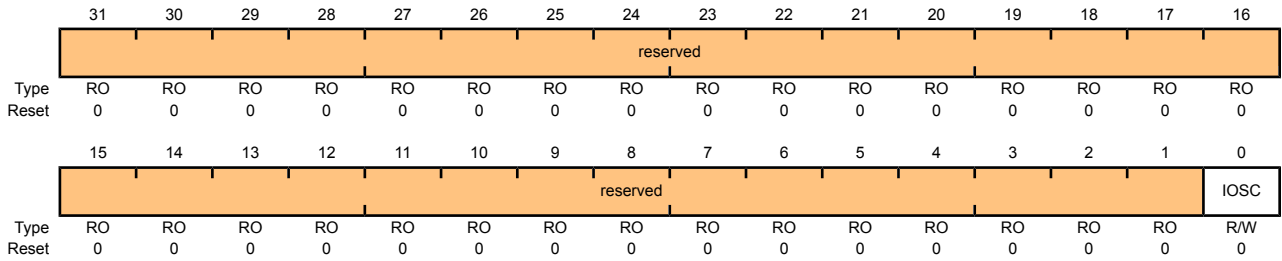

Bit/Field	Name	Type	Reset	Description
31:1	reserved	RO	0x0	Software should not rely on the value of a reserved bit. To provide compatibility with future products, the value of a reserved bit should be preserved across a read-modify-write operation.
0	IOSC	R/W	0	IOSC Clock Source When set, forces IOSC to be clock source during Deep-Sleep (overrides DSOSCSRC field if set)

Register 11: Clock Verification Clear (CLKVCLR), offset 0x150

This register is provided as a means of clearing the clock verification circuits by software. Since the clock verification circuits force a known good clock to control the process, the controller is allowed the opportunity to solve the problem and clear the verification fault. This register clears all clock verification faults. To clear a clock verification fault, the VERCLR bit must be set and then cleared by software. This bit is not self-clearing.

Clock Verification Clear (CLKVCLR)

Base 0x400F.E000
Offset 0x150
Type R/W, reset 0x0000.0000

	31	30	29	28	27	26	25	24	23	22	21	20	19	18	17	16
	reserved															
Type	RO	RO	RO	RO	RO	RO	RO	RO	RO	RO	RO	RO	RO	RO	RO	RO
Reset	0	0	0	0	0	0	0	0	0	0	0	0	0	0	0	0
	15	14	13	12	11	10	9	8	7	6	5	4	3	2	1	0
	reserved															VERCLR
Type	RO	RO	RO	RO	RO	RO	RO	RO	RO	RO	RO	RO	RO	RO	RO	R/W
Reset	0	0	0	0	0	0	0	0	0	0	0	0	0	0	0	0

Bit/Field	Name	Type	Reset	Description
31:1	reserved	RO	0	Software should not rely on the value of a reserved bit. To provide compatibility with future products, the value of a reserved bit should be preserved across a read-modify-write operation.
0	VERCLR	R/W	0	Clock Verification Clear Clears clock verification faults.

Register 12: Allow Unregulated LDO to Reset the Part (LDOARST), offset 0x160

This register is provided as a means of allowing the LDO to reset the part if the voltage goes unregulated. Use this register to choose whether to automatically reset the part if the LDO goes unregulated, based on the design tolerance for LDO fluctuation.

Allow Unregulated LDO to Reset the Part (LDOARST)

Base 0x400F.E000
 Offset 0x160
 Type R/W, reset 0x0000.0000

	31	30	29	28	27	26	25	24	23	22	21	20	19	18	17	16
	reserved															
Type	RO	RO	RO	RO	RO	RO	RO	RO	RO	RO	RO	RO	RO	RO	RO	RO
Reset	0	0	0	0	0	0	0	0	0	0	0	0	0	0	0	0
	15	14	13	12	11	10	9	8	7	6	5	4	3	2	1	0
	reserved															LDOARST
Type	RO	RO	RO	RO	RO	RO	RO	RO	RO	RO	RO	RO	RO	RO	RO	R/W
Reset	0	0	0	0	0	0	0	0	0	0	0	0	0	0	0	0

Bit/Field	Name	Type	Reset	Description
31:1	reserved	RO	0	Software should not rely on the value of a reserved bit. To provide compatibility with future products, the value of a reserved bit should be preserved across a read-modify-write operation.
0	LDOARST	R/W	0	LDO Reset When set, allows unregulated LDO output to reset the part.

Register 13: Device Identification 1 (DID1), offset 0x004

This register identifies the device family, part number, temperature range, and package type.

Device Identification 1 (DID1)

Base 0x400F.E000

Offset 0x004

Type RO, reset -

	31	30	29	28	27	26	25	24	23	22	21	20	19	18	17	16
	VER				FAM				PARTNO							
Type	RO	RO	RO	RO	RO	RO	RO	RO	RO	RO	RO	RO	RO	RO	RO	RO
Reset	0	0	0	0	0	0	0	0	0	0	1	1	0	1	0	1
	15	14	13	12	11	10	9	8	7	6	5	4	3	2	1	0
	reserved								TEMP			PKG		ROHS	QUAL	
Type	RO	RO	RO	RO	RO	RO	RO	RO	RO	RO	RO	RO	RO	RO	RO	RO
Reset	0	0	0	0	0	0	0	0	0	-	-	-	0	1	1	-

Bit/Field	Name	Type	Reset	Description
31:28	VER	RO	0x0	<p>DID1 Version</p> <p>This field defines the DID1 register format version. The version number is numeric. The value of the <code>VER</code> field is encoded as follows (all other encodings are reserved):</p> <p>Value Description</p> <p>0x0 Initial DID1 register format definition, indicating a Stellaris LM3Snnn device.</p>
27:24	FAM	RO	0x0	<p>Family</p> <p>This field provides the family identification of the device within the Luminary Micro product portfolio. The value is encoded as follows (all other encodings are reserved):</p> <p>Value Description</p> <p>0x0 Stellaris family of microcontollers, that is, all devices with external part numbers starting with LM3S.</p>
23:16	PARTNO	RO	0x35	<p>Part Number</p> <p>This field provides the part number of the device within the family. The value is encoded as follows (all other encodings are reserved):</p> <p>Value Description</p> <p>0x35 LM3S828</p>
15:8	reserved	RO	0	<p>Software should not rely on the value of a reserved bit. To provide compatibility with future products, the value of a reserved bit should be preserved across a read-modify-write operation.</p>

Bit/Field	Name	Type	Reset	Description								
7:5	TEMP	RO	-	<p>Temperature Range</p> <p>This field specifies the temperature rating of the device. The value is encoded as follows (all other encodings are reserved):</p> <table><thead><tr><th>Value</th><th>Description</th></tr></thead><tbody><tr><td>0x0</td><td>Commercial temperature range (0°C to 70°C)</td></tr><tr><td>0x1</td><td>Industrial temperature range (-40°C to 85°C)</td></tr><tr><td>0x2</td><td>Extended temperature range (-40°C to 105°C)</td></tr></tbody></table>	Value	Description	0x0	Commercial temperature range (0°C to 70°C)	0x1	Industrial temperature range (-40°C to 85°C)	0x2	Extended temperature range (-40°C to 105°C)
Value	Description											
0x0	Commercial temperature range (0°C to 70°C)											
0x1	Industrial temperature range (-40°C to 85°C)											
0x2	Extended temperature range (-40°C to 105°C)											
4:3	PKG	RO	0x1	<p>Package Type</p> <p>This field specifies the package type. The value is encoded as follows (all other encodings are reserved):</p> <table><thead><tr><th>Value</th><th>Description</th></tr></thead><tbody><tr><td>0x1</td><td>48-pin LQFP package</td></tr></tbody></table>	Value	Description	0x1	48-pin LQFP package				
Value	Description											
0x1	48-pin LQFP package											
2	ROHS	RO	1	<p>RoHS-Compliance</p> <p>This bit specifies whether the device is RoHS-compliant. A 1 indicates the part is RoHS-compliant.</p>								
1:0	QUAL	RO	-	<p>Qualification Status</p> <p>This field specifies the qualification status of the device. The value is encoded as follows (all other encodings are reserved):</p> <table><thead><tr><th>Value</th><th>Description</th></tr></thead><tbody><tr><td>0x0</td><td>Engineering Sample (unqualified)</td></tr><tr><td>0x1</td><td>Pilot Production (unqualified)</td></tr><tr><td>0x2</td><td>Fully Qualified</td></tr></tbody></table>	Value	Description	0x0	Engineering Sample (unqualified)	0x1	Pilot Production (unqualified)	0x2	Fully Qualified
Value	Description											
0x0	Engineering Sample (unqualified)											
0x1	Pilot Production (unqualified)											
0x2	Fully Qualified											

Register 14: Device Capabilities 0 (DC0), offset 0x008

This register is predefined by the part and can be used to verify features.

Device Capabilities 0 (DC0)

Base 0x400F.E000

Offset 0x008

Type RO, reset 0x001F.001F

	31	30	29	28	27	26	25	24	23	22	21	20	19	18	17	16
	SRAMSZ															
Type	RO	RO	RO	RO	RO	RO	RO	RO	RO	RO	RO	RO	RO	RO	RO	RO
Reset	0	0	0	0	0	0	0	0	0	0	0	1	1	1	1	1
	15	14	13	12	11	10	9	8	7	6	5	4	3	2	1	0
	FLASHSZ															
Type	RO	RO	RO	RO	RO	RO	RO	RO	RO	RO	RO	RO	RO	RO	RO	RO
Reset	0	0	0	0	0	0	0	0	0	0	0	1	1	1	1	1

Bit/Field	Name	Type	Reset	Description
31:16	SRAMSZ	RO	0x001F	SRAM Size Indicates the size of the on-chip SRAM memory. Value Description 0x001F 8 KB of SRAM
15:0	FLASHSZ	RO	0x001F	Flash Size Indicates the size of the on-chip flash memory. Value Description 0x001F 64 KB of Flash

Register 15: Device Capabilities 1 (DC1), offset 0x010

This register provides a list of features available in the system. The Stellaris family uses this register format to indicate the availability of the following family features in the specific device: PWM, ADC, Watchdog timer, and debug capabilities. This register also indicates the maximum clock frequency and maximum ADC sample rate. The format of this register is consistent with the **RCGC0**, **SCGC0**, and **DCGC0** clock control registers and the **SRCR0** software reset control register.

Device Capabilities 1 (DC1)

Base 0x400F.E000
 Offset 0x010
 Type RO, reset 0x0001.33BF

	31	30	29	28	27	26	25	24	23	22	21	20	19	18	17	16
	reserved															ADC
Type	RO	RO	RO	RO	RO	RO	RO	RO	RO	RO	RO	RO	RO	RO	RO	RO
Reset	0	0	0	0	0	0	0	0	0	0	0	0	0	0	0	1
	15	14	13	12	11	10	9	8	7	6	5	4	3	2	1	0
	MINSYSDIV			reserved		MAXADCSPD		MPU	reserved		TEMPSNS	PLL	WDT	SWO	SWD	JTAG
Type	RO	RO	RO	RO	RO	RO	RO	RO	RO	RO	RO	RO	RO	RO	RO	RO
Reset	0	0	1	1	0	0	1	1	1	0	1	1	1	1	1	1

Bit/Field	Name	Type	Reset	Description
31:17	reserved	RO	0	Software should not rely on the value of a reserved bit. To provide compatibility with future products, the value of a reserved bit should be preserved across a read-modify-write operation.
16	ADC	RO	1	ADC Module Present When set, indicates that the ADC module is present.
15:12	MINSYSDIV	RO	0x3	System Clock Divider Minimum 4-bit divider value for system clock. The reset value is hardware-dependent. See the RCC register for how to change the system clock divisor using the SYSDIV bit. Value Description 0x3 Specifies a 50-MHz CPU clock with a PLL divider of 4.
11:10	reserved	RO	0	Software should not rely on the value of a reserved bit. To provide compatibility with future products, the value of a reserved bit should be preserved across a read-modify-write operation.
9:8	MAXADCSPD	RO	0x3	Max ADC Speed Indicates the maximum rate at which the ADC samples data. Value Description 0x3 1M samples/second
7	MPU	RO	1	MPU Present When set, indicates that the Cortex-M3 Memory Protection Unit (MPU) module is present. See the ARM Cortex-M3 Technical Reference Manual for details on the MPU.

Bit/Field	Name	Type	Reset	Description
6	reserved	RO	0	Software should not rely on the value of a reserved bit. To provide compatibility with future products, the value of a reserved bit should be preserved across a read-modify-write operation.
5	TEMPSNS	RO	1	Temp Sensor Present When set, indicates that the on-chip temperature sensor is present.
4	PLL	RO	1	PLL Present When set, indicates that the on-chip Phase Locked Loop (PLL) is present.
3	WDT	RO	1	Watchdog Timer Present When set, indicates that a watchdog timer is present.
2	SWO	RO	1	SWO Trace Port Present When set, indicates that the Serial Wire Output (SWO) trace port is present.
1	SWD	RO	1	SWD Present When set, indicates that the Serial Wire Debugger (SWD) is present.
0	JTAG	RO	1	JTAG Present When set, indicates that the JTAG debugger interface is present.

Register 16: Device Capabilities 2 (DC2), offset 0x014

This register provides a list of features available in the system. The Stellaris family uses this register format to indicate the availability of the following family features in the specific device: Analog Comparators, General-Purpose Timers, I2Cs, QEIs, SSIs, and UARTs. The format of this register is consistent with the **RCGC1**, **SCGC1**, and **DCGC1** clock control registers and the **SRCR1** software reset control register.

Device Capabilities 2 (DC2)

Base 0x400F.E000

Offset 0x014

Type RO, reset 0x0007.1013

	31	30	29	28	27	26	25	24	23	22	21	20	19	18	17	16
	reserved													TIMER2	TIMER1	TIMER0
Type	RO	RO	RO	RO	RO	RO	RO	RO	RO	RO	RO	RO	RO	RO	RO	RO
Reset	0	0	0	0	0	0	0	0	0	0	0	0	0	1	1	1
	15	14	13	12	11	10	9	8	7	6	5	4	3	2	1	0
	reserved		I2C0	reserved								SSI0	reserved		UART1	UART0
Type	RO	RO	RO	RO	RO	RO	RO	RO	RO	RO	RO	RO	RO	RO	RO	RO
Reset	0	0	0	1	0	0	0	0	0	0	0	1	0	0	1	1

Bit/Field	Name	Type	Reset	Description
31:19	reserved	RO	0	Software should not rely on the value of a reserved bit. To provide compatibility with future products, the value of a reserved bit should be preserved across a read-modify-write operation.
18	TIMER2	RO	1	Timer 2 Present When set, indicates that General-Purpose Timer module 2 is present.
17	TIMER1	RO	1	Timer 1 Present When set, indicates that General-Purpose Timer module 1 is present.
16	TIMER0	RO	1	Timer 0 Present When set, indicates that General-Purpose Timer module 0 is present.
15:13	reserved	RO	0	Software should not rely on the value of a reserved bit. To provide compatibility with future products, the value of a reserved bit should be preserved across a read-modify-write operation.
12	I2C0	RO	1	I2C Module 0 Present When set, indicates that I2C module 0 is present.
11:5	reserved	RO	0	Software should not rely on the value of a reserved bit. To provide compatibility with future products, the value of a reserved bit should be preserved across a read-modify-write operation.
4	SSI0	RO	1	SSI0 Present When set, indicates that SSI module 0 is present.
3:2	reserved	RO	0	Software should not rely on the value of a reserved bit. To provide compatibility with future products, the value of a reserved bit should be preserved across a read-modify-write operation.

Bit/Field	Name	Type	Reset	Description
1	UART1	RO	1	UART1 Present When set, indicates that UART module 1 is present.
0	UART0	RO	1	UART0 Present When set, indicates that UART module 0 is present.

Register 17: Device Capabilities 3 (DC3), offset 0x018

This register provides a list of features available in the system. The Stellaris family uses this register format to indicate the availability of the following family features in the specific device: Analog Comparator I/Os, CCP I/Os, ADC I/Os, and PWM I/Os.

Device Capabilities 3 (DC3)

Base 0x400F.E000
 Offset 0x018
 Type RO, reset 0xBFFF.0000

	31	30	29	28	27	26	25	24	23	22	21	20	19	18	17	16
	32KHZ	reserved	CCP5	CCP4	CCP3	CCP2	CCP1	CCP0	ADC7	ADC6	ADC5	ADC4	ADC3	ADC2	ADC1	ADC0
Type	RO	RO	RO	RO	RO	RO	RO	RO	RO	RO	RO	RO	RO	RO	RO	RO
Reset	1	0	1	1	1	1	1	1	1	1	1	1	1	1	1	1
	15	14	13	12	11	10	9	8	7	6	5	4	3	2	1	0
	reserved															
Type	RO	RO	RO	RO	RO	RO	RO	RO	RO	RO	RO	RO	RO	RO	RO	RO
Reset	0	0	0	0	0	0	0	0	0	0	0	0	0	0	0	0

Bit/Field	Name	Type	Reset	Description
31	32KHZ	RO	1	32KHz Input Clock Available When set, indicates the 32KHz pin or an even CCP pin is present and can be used as a 32-KHz input clock.
30	reserved	RO	0	Software should not rely on the value of a reserved bit. To provide compatibility with future products, the value of a reserved bit should be preserved across a read-modify-write operation.
29	CCP5	RO	1	CCP5 Pin Present When set, indicates that Capture/Compare/PWM pin 5 is present.
28	CCP4	RO	1	CCP4 Pin Present When set, indicates that Capture/Compare/PWM pin 4 is present.
27	CCP3	RO	1	CCP3 Pin Present When set, indicates that Capture/Compare/PWM pin 3 is present.
26	CCP2	RO	1	CCP2 Pin Present When set, indicates that Capture/Compare/PWM pin 2 is present.
25	CCP1	RO	1	CCP1 Pin Present When set, indicates that Capture/Compare/PWM pin 1 is present.
24	CCP0	RO	1	CCP0 Pin Present When set, indicates that Capture/Compare/PWM pin 0 is present.
23	ADC7	RO	1	ADC7 Pin Present When set, indicates that ADC pin 7 is present.
22	ADC6	RO	1	ADC6 Pin Present When set, indicates that ADC pin 6 is present.

Bit/Field	Name	Type	Reset	Description
21	ADC5	RO	1	ADC5 Pin Present When set, indicates that ADC pin 5 is present.
20	ADC4	RO	1	ADC4 Pin Present When set, indicates that ADC pin 4 is present.
19	ADC3	RO	1	ADC3 Pin Present When set, indicates that ADC pin 3 is present.
18	ADC2	RO	1	ADC2 Pin Present When set, indicates that ADC pin 2 is present.
17	ADC1	RO	1	ADC1 Pin Present When set, indicates that ADC pin 1 is present.
16	ADC0	RO	1	ADC0 Pin Present When set, indicates that ADC pin 0 is present.
15:0	reserved	RO	0	Software should not rely on the value of a reserved bit. To provide compatibility with future products, the value of a reserved bit should be preserved across a read-modify-write operation.

Register 18: Device Capabilities 4 (DC4), offset 0x01C

This register provides a list of features available in the system. The Stellaris family uses this register format to indicate the availability of GPIOs in the specific device. The format of this register is consistent with the **RCGC2**, **SCGC2**, and **DCGC2** clock control registers and the **SRCR2** software reset control register.

Device Capabilities 4 (DC4)

Base 0x400F.E000
 Offset 0x01C
 Type RO, reset 0x0000.001F

	31	30	29	28	27	26	25	24	23	22	21	20	19	18	17	16	
	reserved																
Type	RO	RO	RO	RO	RO	RO	RO	RO	RO	RO	RO	RO	RO	RO	RO	RO	
Reset	0	0	0	0	0	0	0	0	0	0	0	0	0	0	0	0	
	15	14	13	12	11	10	9	8	7	6	5	4	3	2	1	0	
	reserved												GPIOE	GPIOD	GPIOC	GPIOB	GPIOA
Type	RO	RO	RO	RO	RO	RO	RO	RO	RO	RO	RO	RO	RO	RO	RO	RO	
Reset	0	0	0	0	0	0	0	0	0	0	0	0	1	1	1	1	

Bit/Field	Name	Type	Reset	Description
31:5	reserved	RO	0	Software should not rely on the value of a reserved bit. To provide compatibility with future products, the value of a reserved bit should be preserved across a read-modify-write operation.
4	GPIOE	RO	1	GPIO Port E Present When set, indicates that GPIO Port E is present.
3	GPIOD	RO	1	GPIO Port D Present When set, indicates that GPIO Port D is present.
2	GPIOC	RO	1	GPIO Port C Present When set, indicates that GPIO Port C is present.
1	GPIOB	RO	1	GPIO Port B Present When set, indicates that GPIO Port B is present.
0	GPIOA	RO	1	GPIO Port A Present When set, indicates that GPIO Port A is present.

Register 19: Run Mode Clock Gating Control Register 0 (RCGC0), offset 0x100

This register controls the clock gating logic. Each bit controls a clock enable for a given interface, function, or unit. If set, the unit receives a clock and functions. Otherwise, the unit is unclocked and disabled (saving power). If the unit is unclocked, reads or writes to the unit will generate a bus fault. The reset state of these bits is 0 (unclocked) unless otherwise noted, so that all functional units are disabled. It is the responsibility of software to enable the ports necessary for the application. Note that these registers may contain more bits than there are interfaces, functions, or units to control. This is to assure reasonable code compatibility with other family and future parts. **RCGC0** is the clock configuration register for running operation, **SCGC0** for Sleep operation, and **DCGC0** for Deep-Sleep operation. Setting the **ACG** bit in the **Run-Mode Clock Configuration (RCC)** register specifies that the system uses sleep modes.

Run Mode Clock Gating Control Register 0 (RCGC0)

Base 0x400F.E000
 Offset 0x100
 Type R/W, reset 0x00000040

	31	30	29	28	27	26	25	24	23	22	21	20	19	18	17	16
	reserved															ADC
Type	RO	RO	RO	RO	RO	RO	RO	RO	RO	RO	RO	RO	RO	RO	RO	R/W
Reset	0	0	0	0	0	0	0	0	0	0	0	0	0	0	0	0
	15	14	13	12	11	10	9	8	7	6	5	4	3	2	1	0
	reserved						MAXADCSPD	reserved					WDT	reserved		
Type	RO	RO	RO	RO	RO	RO	R/W	R/W	RO	RO	RO	RO	R/W	RO	RO	RO
Reset	0	0	0	0	0	0	0	0	0	0	0	0	0	0	0	0

Bit/Field	Name	Type	Reset	Description										
31:17	reserved	RO	0	Software should not rely on the value of a reserved bit. To provide compatibility with future products, the value of a reserved bit should be preserved across a read-modify-write operation.										
16	ADC	R/W	0	<p>ADC0 Clock Gating Control</p> <p>This bit controls the clock gating for SAR ADC module 0. If set, the unit receives a clock and functions. Otherwise, the unit is unclocked and disabled. If the unit is unclocked, a read or write to the unit generates a bus fault.</p>										
15:10	reserved	RO	0	Software should not rely on the value of a reserved bit. To provide compatibility with future products, the value of a reserved bit should be preserved across a read-modify-write operation.										
9:8	MAXADCSPD	R/W	0	<p>ADC Sample Speed</p> <p>This field sets the rate at which the ADC samples data. You cannot set the rate higher than the maximum rate. You can set the sample rate by setting the MAXADCSPD bit as follows:</p> <table border="1"> <thead> <tr> <th>Value</th> <th>Description</th> </tr> </thead> <tbody> <tr> <td>0x3</td> <td>1M samples/second</td> </tr> <tr> <td>0x2</td> <td>500K samples/second</td> </tr> <tr> <td>0x1</td> <td>250K samples/second</td> </tr> <tr> <td>0x0</td> <td>125K samples/second</td> </tr> </tbody> </table>	Value	Description	0x3	1M samples/second	0x2	500K samples/second	0x1	250K samples/second	0x0	125K samples/second
Value	Description													
0x3	1M samples/second													
0x2	500K samples/second													
0x1	250K samples/second													
0x0	125K samples/second													

Bit/Field	Name	Type	Reset	Description
7:4	reserved	RO	0	Software should not rely on the value of a reserved bit. To provide compatibility with future products, the value of a reserved bit should be preserved across a read-modify-write operation.
3	WDT	R/W	0	WDT Clock Gating Control This bit controls the clock gating for the WDT module. If set, the unit receives a clock and functions. Otherwise, the unit is unlocked and disabled. If the unit is unlocked, a read or write to the unit generates a bus fault.
2:0	reserved	RO	0	Software should not rely on the value of a reserved bit. To provide compatibility with future products, the value of a reserved bit should be preserved across a read-modify-write operation.

Register 20: Sleep Mode Clock Gating Control Register 0 (SCGC0), offset 0x110

This register controls the clock gating logic. Each bit controls a clock enable for a given interface, function, or unit. If set, the unit receives a clock and functions. Otherwise, the unit is unlocked and disabled (saving power). If the unit is unlocked, reads or writes to the unit will generate a bus fault. The reset state of these bits is 0 (unlocked) unless otherwise noted, so that all functional units are disabled. It is the responsibility of software to enable the ports necessary for the application. Note that these registers may contain more bits than there are interfaces, functions, or units to control. This is to assure reasonable code compatibility with other family and future parts. **RCGC0** is the clock configuration register for running operation, **SCGC0** for Sleep operation, and **DCGC0** for Deep-Sleep operation. Setting the **ACG** bit in the **Run-Mode Clock Configuration (RCC)** register specifies that the system uses sleep modes.

Sleep Mode Clock Gating Control Register 0 (SCGC0)

Base 0x400F.E000

Offset 0x110

Type R/W, reset 0x00000040

	31	30	29	28	27	26	25	24	23	22	21	20	19	18	17	16	
	reserved															ADC	
Type	RO	RO	RO	RO	RO	RO	RO	RO	RO	RO	RO	RO	RO	RO	RO	RO	R/W
Reset	0	0	0	0	0	0	0	0	0	0	0	0	0	0	0	0	0
	15	14	13	12	11	10	9	8	7	6	5	4	3	2	1	0	
	reserved						MAXADCSPD	reserved					WDT	reserved			
Type	RO	RO	RO	RO	RO	RO	R/W	R/W	RO	RO	RO	RO	R/W	RO	RO	RO	
Reset	0	0	0	0	0	0	0	0	0	0	0	0	0	0	0	0	

Bit/Field	Name	Type	Reset	Description										
31:17	reserved	RO	0	Software should not rely on the value of a reserved bit. To provide compatibility with future products, the value of a reserved bit should be preserved across a read-modify-write operation.										
16	ADC	R/W	0	<p>ADC0 Clock Gating Control</p> <p>This bit controls the clock gating for SAR ADC module 0. If set, the unit receives a clock and functions. Otherwise, the unit is unlocked and disabled. If the unit is unlocked, a read or write to the unit generates a bus fault.</p>										
15:10	reserved	RO	0	Software should not rely on the value of a reserved bit. To provide compatibility with future products, the value of a reserved bit should be preserved across a read-modify-write operation.										
9:8	MAXADCSPD	R/W	0	<p>ADC Sample Speed</p> <p>This field sets the rate at which the ADC samples data. You cannot set the rate higher than the maximum rate. You can set the sample rate by setting the MAXADCSPD bit as follows:</p> <table border="1"> <thead> <tr> <th>Value</th> <th>Description</th> </tr> </thead> <tbody> <tr> <td>0x3</td> <td>1M samples/second</td> </tr> <tr> <td>0x2</td> <td>500K samples/second</td> </tr> <tr> <td>0x1</td> <td>250K samples/second</td> </tr> <tr> <td>0x0</td> <td>125K samples/second</td> </tr> </tbody> </table>	Value	Description	0x3	1M samples/second	0x2	500K samples/second	0x1	250K samples/second	0x0	125K samples/second
Value	Description													
0x3	1M samples/second													
0x2	500K samples/second													
0x1	250K samples/second													
0x0	125K samples/second													

Bit/Field	Name	Type	Reset	Description
7:4	reserved	RO	0	Software should not rely on the value of a reserved bit. To provide compatibility with future products, the value of a reserved bit should be preserved across a read-modify-write operation.
3	WDT	R/W	0	WDT Clock Gating Control This bit controls the clock gating for the WDT module. If set, the unit receives a clock and functions. Otherwise, the unit is unlocked and disabled. If the unit is unlocked, a read or write to the unit generates a bus fault.
2:0	reserved	RO	0	Software should not rely on the value of a reserved bit. To provide compatibility with future products, the value of a reserved bit should be preserved across a read-modify-write operation.

Register 21: Deep Sleep Mode Clock Gating Control Register 0 (DCGC0), offset 0x120

This register controls the clock gating logic. Each bit controls a clock enable for a given interface, function, or unit. If set, the unit receives a clock and functions. Otherwise, the unit is unlocked and disabled (saving power). If the unit is unlocked, reads or writes to the unit will generate a bus fault. The reset state of these bits is 0 (unlocked) unless otherwise noted, so that all functional units are disabled. It is the responsibility of software to enable the ports necessary for the application. Note that these registers may contain more bits than there are interfaces, functions, or units to control. This is to assure reasonable code compatibility with other family and future parts. **RCGC0** is the clock configuration register for running operation, **SCGC0** for Sleep operation, and **DCGC0** for Deep-Sleep operation. Setting the **ACG** bit in the **Run-Mode Clock Configuration (RCC)** register specifies that the system uses sleep modes.

Deep Sleep Mode Clock Gating Control Register 0 (DCGC0)

Base 0x400F.E000
Offset 0x120
Type R/W, reset 0x00000040

	31	30	29	28	27	26	25	24	23	22	21	20	19	18	17	16
	reserved															ADC
Type	RO	RO	RO	RO	RO	RO	RO	RO	RO	RO	RO	RO	RO	RO	RO	R/W
Reset	0	0	0	0	0	0	0	0	0	0	0	0	0	0	0	0
	15	14	13	12	11	10	9	8	7	6	5	4	3	2	1	0
	reserved						MAXADCSPD	reserved					WDT	reserved		
Type	RO	RO	RO	RO	RO	RO	R/W	R/W	RO	RO	RO	RO	R/W	RO	RO	RO
Reset	0	0	0	0	0	0	0	0	0	0	0	0	0	0	0	0

Bit/Field	Name	Type	Reset	Description										
31:17	reserved	RO	0	Software should not rely on the value of a reserved bit. To provide compatibility with future products, the value of a reserved bit should be preserved across a read-modify-write operation.										
16	ADC	R/W	0	ADC0 Clock Gating Control This bit controls the clock gating for SAR ADC module 0. If set, the unit receives a clock and functions. Otherwise, the unit is unlocked and disabled. If the unit is unlocked, a read or write to the unit generates a bus fault.										
15:10	reserved	RO	0	Software should not rely on the value of a reserved bit. To provide compatibility with future products, the value of a reserved bit should be preserved across a read-modify-write operation.										
9:8	MAXADCSPD	R/W	0	ADC Sample Speed This field sets the rate at which the ADC samples data. You cannot set the rate higher than the maximum rate. You can set the sample rate by setting the MAXADCSPD bit as follows: <table border="1"> <thead> <tr> <th>Value</th> <th>Description</th> </tr> </thead> <tbody> <tr> <td>0x3</td> <td>1M samples/second</td> </tr> <tr> <td>0x2</td> <td>500K samples/second</td> </tr> <tr> <td>0x1</td> <td>250K samples/second</td> </tr> <tr> <td>0x0</td> <td>125K samples/second</td> </tr> </tbody> </table>	Value	Description	0x3	1M samples/second	0x2	500K samples/second	0x1	250K samples/second	0x0	125K samples/second
Value	Description													
0x3	1M samples/second													
0x2	500K samples/second													
0x1	250K samples/second													
0x0	125K samples/second													

Bit/Field	Name	Type	Reset	Description
7:4	reserved	RO	0	Software should not rely on the value of a reserved bit. To provide compatibility with future products, the value of a reserved bit should be preserved across a read-modify-write operation.
3	WDT	R/W	0	WDT Clock Gating Control This bit controls the clock gating for the WDT module. If set, the unit receives a clock and functions. Otherwise, the unit is unlocked and disabled. If the unit is unlocked, a read or write to the unit generates a bus fault.
2:0	reserved	RO	0	Software should not rely on the value of a reserved bit. To provide compatibility with future products, the value of a reserved bit should be preserved across a read-modify-write operation.

Register 22: Run Mode Clock Gating Control Register 1 (RCGC1), offset 0x104

This register controls the clock gating logic. Each bit controls a clock enable for a given interface, function, or unit. If set, the unit receives a clock and functions. Otherwise, the unit is unlocked and disabled (saving power). If the unit is unlocked, reads or writes to the unit will generate a bus fault. The reset state of these bits is 0 (unlocked) unless otherwise noted, so that all functional units are disabled. It is the responsibility of software to enable the ports necessary for the application. Note that these registers may contain more bits than there are interfaces, functions, or units to control. This is to assure reasonable code compatibility with other family and future parts. **RCGC1** is the clock configuration register for running operation, **SCGC1** for Sleep operation, and **DCGC1** for Deep-Sleep operation. Setting the **ACG** bit in the **Run-Mode Clock Configuration (RCC)** register specifies that the system uses sleep modes.

Run Mode Clock Gating Control Register 1 (RCGC1)

Base 0x400F.E000
 Offset 0x104
 Type R/W, reset 0x00000000

	31	30	29	28	27	26	25	24	23	22	21	20	19	18	17	16	
	reserved													TIMER2	TIMER1	TIMER0	
Type	RO	RO	RO	RO	RO	RO	RO	RO	RO	RO	RO	RO	RO	R/W	R/W	R/W	
Reset	0	0	0	0	0	0	0	0	0	0	0	0	0	0	0	0	
	15	14	13	12	11	10	9	8	7	6	5	4	3	2	1	0	
	reserved			I2C0	reserved								SSI0	reserved		UART1	UART0
Type	RO	RO	RO	R/W	RO	RO	RO	RO	RO	RO	RO	R/W	RO	RO	R/W	R/W	
Reset	0	0	0	0	0	0	0	0	0	0	0	0	0	0	0	0	

Bit/Field	Name	Type	Reset	Description
31:19	reserved	RO	0	Software should not rely on the value of a reserved bit. To provide compatibility with future products, the value of a reserved bit should be preserved across a read-modify-write operation.
18	TIMER2	R/W	0	Timer 2 Clock Gating Control This bit controls the clock gating for General-Purpose Timer module 2. If set, the unit receives a clock and functions. Otherwise, the unit is unlocked and disabled. If the unit is unlocked, reads or writes to the unit will generate a bus fault.
17	TIMER1	R/W	0	Timer 1 Clock Gating Control This bit controls the clock gating for General-Purpose Timer module 1. If set, the unit receives a clock and functions. Otherwise, the unit is unlocked and disabled. If the unit is unlocked, reads or writes to the unit will generate a bus fault.
16	TIMER0	R/W	0	Timer 0 Clock Gating Control This bit controls the clock gating for General-Purpose Timer module 0. If set, the unit receives a clock and functions. Otherwise, the unit is unlocked and disabled. If the unit is unlocked, reads or writes to the unit will generate a bus fault.
15:13	reserved	RO	0	Software should not rely on the value of a reserved bit. To provide compatibility with future products, the value of a reserved bit should be preserved across a read-modify-write operation.

Bit/Field	Name	Type	Reset	Description
12	I2C0	R/W	0	I2C0 Clock Gating Control This bit controls the clock gating for I2C module 0. If set, the unit receives a clock and functions. Otherwise, the unit is unlocked and disabled. If the unit is unlocked, reads or writes to the unit will generate a bus fault.
11:5	reserved	RO	0	Software should not rely on the value of a reserved bit. To provide compatibility with future products, the value of a reserved bit should be preserved across a read-modify-write operation.
4	SSI0	R/W	0	SSI0 Clock Gating Control This bit controls the clock gating for SSI module 0. If set, the unit receives a clock and functions. Otherwise, the unit is unlocked and disabled. If the unit is unlocked, reads or writes to the unit will generate a bus fault.
3:2	reserved	RO	0	Software should not rely on the value of a reserved bit. To provide compatibility with future products, the value of a reserved bit should be preserved across a read-modify-write operation.
1	UART1	R/W	0	UART1 Clock Gating Control This bit controls the clock gating for UART module 1. If set, the unit receives a clock and functions. Otherwise, the unit is unlocked and disabled. If the unit is unlocked, reads or writes to the unit will generate a bus fault.
0	UART0	R/W	0	UART0 Clock Gating Control This bit controls the clock gating for UART module 0. If set, the unit receives a clock and functions. Otherwise, the unit is unlocked and disabled. If the unit is unlocked, reads or writes to the unit will generate a bus fault.

Register 23: Sleep Mode Clock Gating Control Register 1 (SCGC1), offset 0x114

This register controls the clock gating logic. Each bit controls a clock enable for a given interface, function, or unit. If set, the unit receives a clock and functions. Otherwise, the unit is unlocked and disabled (saving power). If the unit is unlocked, reads or writes to the unit will generate a bus fault. The reset state of these bits is 0 (unlocked) unless otherwise noted, so that all functional units are disabled. It is the responsibility of software to enable the ports necessary for the application. Note that these registers may contain more bits than there are interfaces, functions, or units to control. This is to assure reasonable code compatibility with other family and future parts. **RCGC1** is the clock configuration register for running operation, **SCGC1** for Sleep operation, and **DCGC1** for Deep-Sleep operation. Setting the **ACG** bit in the **Run-Mode Clock Configuration (RCC)** register specifies that the system uses sleep modes.

Sleep Mode Clock Gating Control Register 1 (SCGC1)

Base 0x400F.E000
Offset 0x114
Type R/W, reset 0x00000000

	31	30	29	28	27	26	25	24	23	22	21	20	19	18	17	16	
	reserved													TIMER2	TIMER1	TIMER0	
Type	RO	RO	RO	RO	RO	RO	RO	RO	RO	RO	RO	RO	RO	R/W	R/W	R/W	
Reset	0	0	0	0	0	0	0	0	0	0	0	0	0	0	0	0	
	15	14	13	12	11	10	9	8	7	6	5	4	3	2	1	0	
	reserved			I2C0	reserved								SSI0	reserved		UART1	UART0
Type	RO	RO	RO	R/W	RO	RO	RO	RO	RO	RO	RO	R/W	RO	RO	R/W	R/W	
Reset	0	0	0	0	0	0	0	0	0	0	0	0	0	0	0	0	

Bit/Field	Name	Type	Reset	Description
31:19	reserved	RO	0	Software should not rely on the value of a reserved bit. To provide compatibility with future products, the value of a reserved bit should be preserved across a read-modify-write operation.
18	TIMER2	R/W	0	Timer 2 Clock Gating Control This bit controls the clock gating for General-Purpose Timer module 2. If set, the unit receives a clock and functions. Otherwise, the unit is unlocked and disabled. If the unit is unlocked, reads or writes to the unit will generate a bus fault.
17	TIMER1	R/W	0	Timer 1 Clock Gating Control This bit controls the clock gating for General-Purpose Timer module 1. If set, the unit receives a clock and functions. Otherwise, the unit is unlocked and disabled. If the unit is unlocked, reads or writes to the unit will generate a bus fault.
16	TIMER0	R/W	0	Timer 0 Clock Gating Control This bit controls the clock gating for General-Purpose Timer module 0. If set, the unit receives a clock and functions. Otherwise, the unit is unlocked and disabled. If the unit is unlocked, reads or writes to the unit will generate a bus fault.
15:13	reserved	RO	0	Software should not rely on the value of a reserved bit. To provide compatibility with future products, the value of a reserved bit should be preserved across a read-modify-write operation.

Bit/Field	Name	Type	Reset	Description
12	I2C0	R/W	0	I2C0 Clock Gating Control This bit controls the clock gating for I2C module 0. If set, the unit receives a clock and functions. Otherwise, the unit is unlocked and disabled. If the unit is unlocked, reads or writes to the unit will generate a bus fault.
11:5	reserved	RO	0	Software should not rely on the value of a reserved bit. To provide compatibility with future products, the value of a reserved bit should be preserved across a read-modify-write operation.
4	SSI0	R/W	0	SSI0 Clock Gating Control This bit controls the clock gating for SSI module 0. If set, the unit receives a clock and functions. Otherwise, the unit is unlocked and disabled. If the unit is unlocked, reads or writes to the unit will generate a bus fault.
3:2	reserved	RO	0	Software should not rely on the value of a reserved bit. To provide compatibility with future products, the value of a reserved bit should be preserved across a read-modify-write operation.
1	UART1	R/W	0	UART1 Clock Gating Control This bit controls the clock gating for UART module 1. If set, the unit receives a clock and functions. Otherwise, the unit is unlocked and disabled. If the unit is unlocked, reads or writes to the unit will generate a bus fault.
0	UART0	R/W	0	UART0 Clock Gating Control This bit controls the clock gating for UART module 0. If set, the unit receives a clock and functions. Otherwise, the unit is unlocked and disabled. If the unit is unlocked, reads or writes to the unit will generate a bus fault.

Register 24: Deep Sleep Mode Clock Gating Control Register 1 (DCGC1), offset 0x124

This register controls the clock gating logic. Each bit controls a clock enable for a given interface, function, or unit. If set, the unit receives a clock and functions. Otherwise, the unit is unlocked and disabled (saving power). If the unit is unlocked, reads or writes to the unit will generate a bus fault. The reset state of these bits is 0 (unlocked) unless otherwise noted, so that all functional units are disabled. It is the responsibility of software to enable the ports necessary for the application. Note that these registers may contain more bits than there are interfaces, functions, or units to control. This is to assure reasonable code compatibility with other family and future parts. **RCGC1** is the clock configuration register for running operation, **SCGC1** for Sleep operation, and **DCGC1** for Deep-Sleep operation. Setting the **ACG** bit in the **Run-Mode Clock Configuration (RCC)** register specifies that the system uses sleep modes.

Deep Sleep Mode Clock Gating Control Register 1 (DCGC1)

Base 0x400F.E000
 Offset 0x124
 Type R/W, reset 0x00000000

	31	30	29	28	27	26	25	24	23	22	21	20	19	18	17	16	
	reserved													TIMER2	TIMER1	TIMER0	
Type	RO	RO	RO	RO	RO	RO	RO	RO	RO	RO	RO	RO	RO	R/W	R/W	R/W	
Reset	0	0	0	0	0	0	0	0	0	0	0	0	0	0	0	0	
	15	14	13	12	11	10	9	8	7	6	5	4	3	2	1	0	
	reserved			I2C0	reserved								SSI0	reserved		UART1	UART0
Type	RO	RO	RO	R/W	RO	RO	RO	RO	RO	RO	RO	R/W	RO	RO	R/W	R/W	
Reset	0	0	0	0	0	0	0	0	0	0	0	0	0	0	0	0	

Bit/Field	Name	Type	Reset	Description
31:19	reserved	RO	0	Software should not rely on the value of a reserved bit. To provide compatibility with future products, the value of a reserved bit should be preserved across a read-modify-write operation.
18	TIMER2	R/W	0	Timer 2 Clock Gating Control This bit controls the clock gating for General-Purpose Timer module 2. If set, the unit receives a clock and functions. Otherwise, the unit is unlocked and disabled. If the unit is unlocked, reads or writes to the unit will generate a bus fault.
17	TIMER1	R/W	0	Timer 1 Clock Gating Control This bit controls the clock gating for General-Purpose Timer module 1. If set, the unit receives a clock and functions. Otherwise, the unit is unlocked and disabled. If the unit is unlocked, reads or writes to the unit will generate a bus fault.
16	TIMER0	R/W	0	Timer 0 Clock Gating Control This bit controls the clock gating for General-Purpose Timer module 0. If set, the unit receives a clock and functions. Otherwise, the unit is unlocked and disabled. If the unit is unlocked, reads or writes to the unit will generate a bus fault.
15:13	reserved	RO	0	Software should not rely on the value of a reserved bit. To provide compatibility with future products, the value of a reserved bit should be preserved across a read-modify-write operation.

Bit/Field	Name	Type	Reset	Description
12	I2C0	R/W	0	I2C0 Clock Gating Control This bit controls the clock gating for I2C module 0. If set, the unit receives a clock and functions. Otherwise, the unit is unlocked and disabled. If the unit is unlocked, reads or writes to the unit will generate a bus fault.
11:5	reserved	RO	0	Software should not rely on the value of a reserved bit. To provide compatibility with future products, the value of a reserved bit should be preserved across a read-modify-write operation.
4	SSI0	R/W	0	SSI0 Clock Gating Control This bit controls the clock gating for SSI module 0. If set, the unit receives a clock and functions. Otherwise, the unit is unlocked and disabled. If the unit is unlocked, reads or writes to the unit will generate a bus fault.
3:2	reserved	RO	0	Software should not rely on the value of a reserved bit. To provide compatibility with future products, the value of a reserved bit should be preserved across a read-modify-write operation.
1	UART1	R/W	0	UART1 Clock Gating Control This bit controls the clock gating for UART module 1. If set, the unit receives a clock and functions. Otherwise, the unit is unlocked and disabled. If the unit is unlocked, reads or writes to the unit will generate a bus fault.
0	UART0	R/W	0	UART0 Clock Gating Control This bit controls the clock gating for UART module 0. If set, the unit receives a clock and functions. Otherwise, the unit is unlocked and disabled. If the unit is unlocked, reads or writes to the unit will generate a bus fault.

Register 25: Run Mode Clock Gating Control Register 2 (RCGC2), offset 0x108

This register controls the clock gating logic. Each bit controls a clock enable for a given interface, function, or unit. If set, the unit receives a clock and functions. Otherwise, the unit is unclocked and disabled (saving power). If the unit is unclocked, reads or writes to the unit will generate a bus fault. The reset state of these bits is 0 (unclocked) unless otherwise noted, so that all functional units are disabled. It is the responsibility of software to enable the ports necessary for the application. Note that these registers may contain more bits than there are interfaces, functions, or units to control. This is to assure reasonable code compatibility with other family and future parts. **RCGC2** is the clock configuration register for running operation, **SCGC2** for Sleep operation, and **DCGC2** for Deep-Sleep operation. Setting the **ACG** bit in the **Run-Mode Clock Configuration (RCC)** register specifies that the system uses sleep modes.

Run Mode Clock Gating Control Register 2 (RCGC2)

Base 0x400F.E000

Offset 0x108

Type R/W, reset 0x00000000

	31	30	29	28	27	26	25	24	23	22	21	20	19	18	17	16	
	reserved																
Type	RO	RO	RO	RO	RO	RO	RO	RO	RO	RO	RO	RO	RO	RO	RO	RO	
Reset	0	0	0	0	0	0	0	0	0	0	0	0	0	0	0	0	
	15	14	13	12	11	10	9	8	7	6	5	4	3	2	1	0	
	reserved												GPIOE	GPIOD	GPIOC	GPIOB	GPIOA
Type	RO	RO	RO	RO	RO	RO	RO	RO	RO	RO	RO	R/W	R/W	R/W	R/W	R/W	
Reset	0	0	0	0	0	0	0	0	0	0	0	0	0	0	0	0	

Bit/Field	Name	Type	Reset	Description
31:5	reserved	RO	0	Software should not rely on the value of a reserved bit. To provide compatibility with future products, the value of a reserved bit should be preserved across a read-modify-write operation.
4	GPIOE	R/W	0	Port E Clock Gating Control This bit controls the clock gating for Port E. If set, the unit receives a clock and functions. Otherwise, the unit is unclocked and disabled. If the unit is unclocked, reads or writes to the unit will generate a bus fault.
3	GPIOD	R/W	0	Port D Clock Gating Control This bit controls the clock gating for Port D. If set, the unit receives a clock and functions. Otherwise, the unit is unclocked and disabled. If the unit is unclocked, reads or writes to the unit will generate a bus fault.
2	GPIOC	R/W	0	Port C Clock Gating Control This bit controls the clock gating for Port C. If set, the unit receives a clock and functions. Otherwise, the unit is unclocked and disabled. If the unit is unclocked, reads or writes to the unit will generate a bus fault.
1	GPIOB	R/W	0	Port B Clock Gating Control This bit controls the clock gating for Port B. If set, the unit receives a clock and functions. Otherwise, the unit is unclocked and disabled. If the unit is unclocked, reads or writes to the unit will generate a bus fault.

Bit/Field	Name	Type	Reset	Description
0	GPIOA	R/W	0	Port A Clock Gating Control This bit controls the clock gating for Port A. If set, the unit receives a clock and functions. Otherwise, the unit is unlocked and disabled. If the unit is unlocked, reads or writes to the unit will generate a bus fault.

Register 26: Sleep Mode Clock Gating Control Register 2 (SCGC2), offset 0x118

This register controls the clock gating logic. Each bit controls a clock enable for a given interface, function, or unit. If set, the unit receives a clock and functions. Otherwise, the unit is unlocked and disabled (saving power). If the unit is unlocked, reads or writes to the unit will generate a bus fault. The reset state of these bits is 0 (unlocked) unless otherwise noted, so that all functional units are disabled. It is the responsibility of software to enable the ports necessary for the application. Note that these registers may contain more bits than there are interfaces, functions, or units to control. This is to assure reasonable code compatibility with other family and future parts. **RCGC2** is the clock configuration register for running operation, **SCGC2** for Sleep operation, and **DCGC2** for Deep-Sleep operation. Setting the **ACG** bit in the **Run-Mode Clock Configuration (RCC)** register specifies that the system uses sleep modes.

Sleep Mode Clock Gating Control Register 2 (SCGC2)

Base 0x400F.E000
Offset 0x118
Type R/W, reset 0x00000000

	31	30	29	28	27	26	25	24	23	22	21	20	19	18	17	16	
	reserved																
Type	RO	RO	RO	RO	RO	RO	RO	RO	RO	RO	RO	RO	RO	RO	RO	RO	
Reset	0	0	0	0	0	0	0	0	0	0	0	0	0	0	0	0	
	15	14	13	12	11	10	9	8	7	6	5	4	3	2	1	0	
	reserved												GPIOE	GPIOD	GPIOC	GPIOB	GPIOA
Type	RO	RO	RO	RO	RO	RO	RO	RO	RO	RO	RO	RO	R/W	R/W	R/W	R/W	R/W
Reset	0	0	0	0	0	0	0	0	0	0	0	0	0	0	0	0	0

Bit/Field	Name	Type	Reset	Description
31:5	reserved	RO	0	Software should not rely on the value of a reserved bit. To provide compatibility with future products, the value of a reserved bit should be preserved across a read-modify-write operation.
4	GPIOE	R/W	0	Port E Clock Gating Control This bit controls the clock gating for Port E. If set, the unit receives a clock and functions. Otherwise, the unit is unlocked and disabled. If the unit is unlocked, reads or writes to the unit will generate a bus fault.
3	GPIOD	R/W	0	Port D Clock Gating Control This bit controls the clock gating for Port D. If set, the unit receives a clock and functions. Otherwise, the unit is unlocked and disabled. If the unit is unlocked, reads or writes to the unit will generate a bus fault.
2	GPIOC	R/W	0	Port C Clock Gating Control This bit controls the clock gating for Port C. If set, the unit receives a clock and functions. Otherwise, the unit is unlocked and disabled. If the unit is unlocked, reads or writes to the unit will generate a bus fault.
1	GPIOB	R/W	0	Port B Clock Gating Control This bit controls the clock gating for Port B. If set, the unit receives a clock and functions. Otherwise, the unit is unlocked and disabled. If the unit is unlocked, reads or writes to the unit will generate a bus fault.

Bit/Field	Name	Type	Reset	Description
0	GPIOA	R/W	0	Port A Clock Gating Control This bit controls the clock gating for Port A. If set, the unit receives a clock and functions. Otherwise, the unit is unlocked and disabled. If the unit is unlocked, reads or writes to the unit will generate a bus fault.

Register 27: Deep Sleep Mode Clock Gating Control Register 2 (DCGC2), offset 0x128

This register controls the clock gating logic. Each bit controls a clock enable for a given interface, function, or unit. If set, the unit receives a clock and functions. Otherwise, the unit is unlocked and disabled (saving power). If the unit is unlocked, reads or writes to the unit will generate a bus fault. The reset state of these bits is 0 (unlocked) unless otherwise noted, so that all functional units are disabled. It is the responsibility of software to enable the ports necessary for the application. Note that these registers may contain more bits than there are interfaces, functions, or units to control. This is to assure reasonable code compatibility with other family and future parts. **RCGC2** is the clock configuration register for running operation, **SCGC2** for Sleep operation, and **DCGC2** for Deep-Sleep operation. Setting the **ACG** bit in the **Run-Mode Clock Configuration (RCC)** register specifies that the system uses sleep modes.

Deep Sleep Mode Clock Gating Control Register 2 (DCGC2)

Base 0x400F.E000
 Offset 0x128
 Type R/W, reset 0x00000000

	31	30	29	28	27	26	25	24	23	22	21	20	19	18	17	16	
	reserved																
Type	RO	RO	RO	RO	RO	RO	RO	RO	RO	RO	RO	RO	RO	RO	RO	RO	
Reset	0	0	0	0	0	0	0	0	0	0	0	0	0	0	0	0	
	15	14	13	12	11	10	9	8	7	6	5	4	3	2	1	0	
	reserved												GPIOE	GPIOD	GPIOC	GPIOB	GPIOA
Type	RO	RO	RO	RO	RO	RO	RO	RO	RO	RO	RO	R/W	R/W	R/W	R/W	R/W	
Reset	0	0	0	0	0	0	0	0	0	0	0	0	0	0	0	0	

Bit/Field	Name	Type	Reset	Description
31:5	reserved	RO	0	Software should not rely on the value of a reserved bit. To provide compatibility with future products, the value of a reserved bit should be preserved across a read-modify-write operation.
4	GPIOE	R/W	0	Port E Clock Gating Control This bit controls the clock gating for Port E. If set, the unit receives a clock and functions. Otherwise, the unit is unlocked and disabled. If the unit is unlocked, reads or writes to the unit will generate a bus fault.
3	GPIOD	R/W	0	Port D Clock Gating Control This bit controls the clock gating for Port D. If set, the unit receives a clock and functions. Otherwise, the unit is unlocked and disabled. If the unit is unlocked, reads or writes to the unit will generate a bus fault.
2	GPIOC	R/W	0	Port C Clock Gating Control This bit controls the clock gating for Port C. If set, the unit receives a clock and functions. Otherwise, the unit is unlocked and disabled. If the unit is unlocked, reads or writes to the unit will generate a bus fault.
1	GPIOB	R/W	0	Port B Clock Gating Control This bit controls the clock gating for Port B. If set, the unit receives a clock and functions. Otherwise, the unit is unlocked and disabled. If the unit is unlocked, reads or writes to the unit will generate a bus fault.

Bit/Field	Name	Type	Reset	Description
0	GPIOA	R/W	0	Port A Clock Gating Control This bit controls the clock gating for Port A. If set, the unit receives a clock and functions. Otherwise, the unit is unlocked and disabled. If the unit is unlocked, reads or writes to the unit will generate a bus fault.

Register 28: Software Reset Control 0 (SRCR0), offset 0x040Writes to this register are masked by the bits in the **Device Capabilities 1 (DC1)** register.

Software Reset Control 0 (SRCR0)

Base 0x400F.E000

Offset 0x040

Type R/W, reset 0x00000000

	31	30	29	28	27	26	25	24	23	22	21	20	19	18	17	16	
	reserved															ADC	
Type	RO	RO	RO	RO	RO	RO	RO	RO	RO	RO	RO	RO	RO	RO	RO	RO	R/W
Reset	0	0	0	0	0	0	0	0	0	0	0	0	0	0	0	0	0
	15	14	13	12	11	10	9	8	7	6	5	4	3	2	1	0	
	reserved											WDT	reserved				
Type	RO	RO	RO	RO	RO	RO	RO	RO	RO	RO	RO	RO	R/W	RO	RO	RO	
Reset	0	0	0	0	0	0	0	0	0	0	0	0	0	0	0	0	

Bit/Field	Name	Type	Reset	Description
31:17	reserved	RO	0	Software should not rely on the value of a reserved bit. To provide compatibility with future products, the value of a reserved bit should be preserved across a read-modify-write operation.
16	ADC	R/W	0	ADC0 Reset Control Reset control for SAR ADC module 0.
15:4	reserved	RO	0	Software should not rely on the value of a reserved bit. To provide compatibility with future products, the value of a reserved bit should be preserved across a read-modify-write operation.
3	WDT	R/W	0	WDT Reset Control Reset control for Watchdog unit.
2:0	reserved	RO	0	Software should not rely on the value of a reserved bit. To provide compatibility with future products, the value of a reserved bit should be preserved across a read-modify-write operation.

Register 29: Software Reset Control 1 (SRCR1), offset 0x044

Writes to this register are masked by the bits in the **Device Capabilities 2 (DC2)** register.

Software Reset Control 1 (SRCR1)

Base 0x400F.E000
 Offset 0x044
 Type R/W, reset 0x00000000

	31	30	29	28	27	26	25	24	23	22	21	20	19	18	17	16
	reserved													TIMER2	TIMER1	TIMER0
Type	RO	RO	RO	RO	RO	RO	RO	RO	RO	RO	RO	RO	RO	R/W	R/W	R/W
Reset	0	0	0	0	0	0	0	0	0	0	0	0	0	0	0	0
	15	14	13	12	11	10	9	8	7	6	5	4	3	2	1	0
	reserved		I2C0	reserved							SSI0	reserved		UART1	UART0	
Type	RO	RO	RO	R/W	RO	RO	RO	RO	RO	RO	RO	R/W	RO	RO	R/W	R/W
Reset	0	0	0	0	0	0	0	0	0	0	0	0	0	0	0	0

Bit/Field	Name	Type	Reset	Description
31:19	reserved	RO	0	Software should not rely on the value of a reserved bit. To provide compatibility with future products, the value of a reserved bit should be preserved across a read-modify-write operation.
18	TIMER2	R/W	0	Timer 2 Reset Control Reset control for General-Purpose Timer module 2.
17	TIMER1	R/W	0	Timer 1 Reset Control Reset control for General-Purpose Timer module 1.
16	TIMER0	R/W	0	Timer 0 Reset Control Reset control for General-Purpose Timer module 0.
15:13	reserved	RO	0	Software should not rely on the value of a reserved bit. To provide compatibility with future products, the value of a reserved bit should be preserved across a read-modify-write operation.
12	I2C0	R/W	0	I2C0 Reset Control Reset control for I2C unit 0.
11:5	reserved	RO	0	Software should not rely on the value of a reserved bit. To provide compatibility with future products, the value of a reserved bit should be preserved across a read-modify-write operation.
4	SSI0	R/W	0	SSI0 Reset Control Reset control for SSI unit 0.
3:2	reserved	RO	0	Software should not rely on the value of a reserved bit. To provide compatibility with future products, the value of a reserved bit should be preserved across a read-modify-write operation.
1	UART1	R/W	0	UART1 Reset Control Reset control for UART unit 1.
0	UART0	R/W	0	UART0 Reset Control Reset control for UART unit 0.

Register 30: Software Reset Control 2 (SRCR2), offset 0x048Writes to this register are masked by the bits in the **Device Capabilities 4 (DC4)** register.

Software Reset Control 2 (SRCR2)

Base 0x400F.E000

Offset 0x048

Type R/W, reset 0x00000000

	31	30	29	28	27	26	25	24	23	22	21	20	19	18	17	16	
	reserved																
Type	RO	RO	RO	RO	RO	RO	RO	RO	RO	RO	RO	RO	RO	RO	RO	RO	
Reset	0	0	0	0	0	0	0	0	0	0	0	0	0	0	0	0	
	15	14	13	12	11	10	9	8	7	6	5	4	3	2	1	0	
	reserved												GPIOE	GPIOD	GPIOC	GPIOB	GPIOA
Type	RO	RO	RO	RO	RO	RO	RO	RO	RO	RO	RO	R/W	R/W	R/W	R/W	R/W	
Reset	0	0	0	0	0	0	0	0	0	0	0	0	0	0	0	0	

Bit/Field	Name	Type	Reset	Description
31:5	reserved	RO	0	Software should not rely on the value of a reserved bit. To provide compatibility with future products, the value of a reserved bit should be preserved across a read-modify-write operation.
4	GPIOE	R/W	0	Port E Reset Control Reset control for GPIO Port E.
3	GPIOD	R/W	0	Port D Reset Control Reset control for GPIO Port D.
2	GPIOC	R/W	0	Port C Reset Control Reset control for GPIO Port C.
1	GPIOB	R/W	0	Port B Reset Control Reset control for GPIO Port B.
0	GPIOA	R/W	0	Port A Reset Control Reset control for GPIO Port A.

7 Internal Memory

The LM3S828 microcontroller comes with 8 KB of bit-banded SRAM and 64 KB of flash memory. The flash controller provides a user-friendly interface, making flash programming a simple task. Flash protection can be applied to the flash memory on a 2-KB block basis.

7.1 Block Diagram

Figure 7-1 on page 108 illustrates the Flash functions. The dashed boxes in the figure indicate registers residing in the System Control module rather than the Flash Control module.

Figure 7-1. Flash Block Diagram

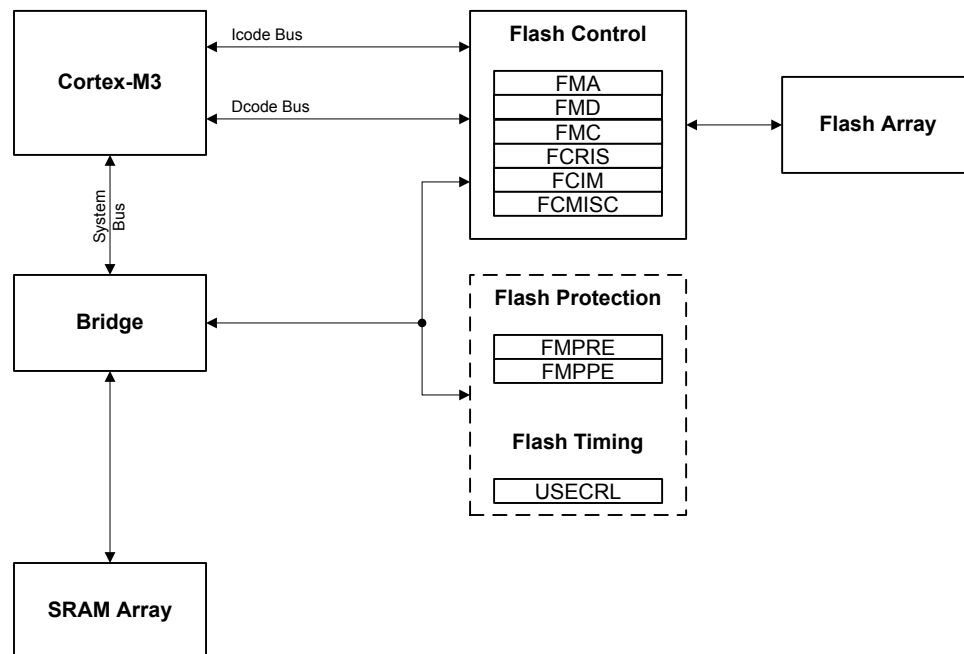

7.2 Functional Description

This section describes the functionality of the SRAM and Flash memories.

7.2.1 SRAM Memory

The internal SRAM of the Stellaris® devices is located at address 0x2000.0000 of the device memory map. To reduce the number of time consuming read-modify-write (RMW) operations, ARM has introduced *bit-banding* technology in the Cortex-M3 processor. With a bit-band-enabled processor, certain regions in the memory map (SRAM and peripheral space) can use address aliases to access individual bits in a single, atomic operation.

The bit-band alias is calculated by using the formula:

$$\text{bit-band alias} = \text{bit-band base} + (\text{byte offset} * 32) + (\text{bit number} * 4)$$

For example, if bit 3 at address 0x2000.1000 is to be modified, the bit-band alias is calculated as:

$$0x2200.0000 + (0x1000 * 32) + (3 * 4) = 0x2202.000C$$

With the alias address calculated, an instruction performing a read/write to address 0x2202.000C allows direct access to only bit 3 of the byte at address 0x2000.1000.

For details about bit-banding, please refer to Chapter 4, “Memory Map” in the *ARM® Cortex™-M3 Technical Reference Manual*.

7.2.2 Flash Memory

The flash is organized as a set of 1-KB blocks that can be individually erased. Erasing a block causes the entire contents of the block to be reset to all 1s. An individual 32-bit word can be programmed to change bits that are currently 1 to a 0. These blocks are paired into a set of 2-KB blocks that can be individually protected. The protection allows blocks to be marked as read-only or execute-only, providing different levels of code protection. Read-only blocks cannot be erased or programmed, protecting the contents of those blocks from being modified. Execute-only blocks cannot be erased or programmed, and can only be read by the controller instruction fetch mechanism, protecting the contents of those blocks from being read by either the controller or by a debugger.

See also “Serial Flash Loader” on page 387 for a preprogrammed flash-resident utility used to download code to the flash memory of a device without the use of a debug interface.

7.2.2.1 Flash Memory Timing

The timing for the flash is automatically handled by the flash controller. However, in order to do so, it must know the clock rate of the system in order to time its internal signals properly. The number of clock cycles per microsecond must be provided to the flash controller for it to accomplish this timing. It is software's responsibility to keep the flash controller updated with this information via the **Usec Reload (USECRL)** register.

On reset, the **USECRL** register is loaded with a value that configures the flash timing so that it works with the maximum clock rate of the part. If software changes the system operating frequency, the new operating frequency minus 1 (in MHz) must be loaded into **USECRL** before any flash modifications are attempted. For example, if the device is operating at a speed of 20 MHz, a value of 0x13 (20-1) must be written to the **USECRL** register.

7.2.2.2 Flash Memory Protection

The user is provided two forms of flash protection per 2-KB flash blocks in two 32-bit wide registers. The protection policy for each form is controlled by individual bits (per policy per block) in the **FMPPEn** and **FMPREn** registers.

- **Flash Memory Protection Program Enable (FMPPEn):** If set, the block may be programmed (written) or erased. If cleared, the block may not be changed.
- **Flash Memory Protection Read Enable (FMPREn):** If set, the block may be executed or read by software or debuggers. If cleared, the block may only be executed and contents of the memory block are prohibited from being accessed as data.

The policies may be combined as shown in Table 7-1 on page 109.

Table 7-1. Flash Protection Policy Combinations

FMPPEn	FMPREn	Protection
0	0	Execute-only protection. The block may only be executed and may not be written or erased. This mode is used to protect code.

FMPPEn	FMPREn	Protection
1	0	The block may be written, erased or executed, but not read. This combination is unlikely to be used.
0	1	Read-only protection. The block may be read or executed but may not be written or erased. This mode is used to lock the block from further modification while allowing any read or execute access.
1	1	No protection. The block may be written, erased, executed or read.

An access that attempts to program or erase a PE-protected block is prohibited. A controller interrupt may be optionally generated (by setting the `AMASK` bit in the **FIM** register) to alert software developers of poorly behaving software during the development and debug phases.

An access that attempts to read an RE-protected block is prohibited. Such accesses return data filled with all 0s. A controller interrupt may be optionally generated to alert software developers of poorly behaving software during the development and debug phases.

The factory settings for the **FMPREn** and **FMPPEn** registers are a value of 1 for all implemented banks. This implements a policy of open access and programmability. The register bits may be changed by writing the specific register bit. The changes are not permanent until the register is committed (saved), at which point the bit change is permanent. If a bit is changed from a 1 to a 0 and not committed, it may be restored by executing a power-on reset sequence.

7.2.2.3 Flash Protection by Disabling Debug Access

Flash memory may also be protected by permanently disabling access to the Debug Access Port (DAP) through the JTAG and SWD interfaces. This is accomplished by clearing the `DBG` field of the **FMPRE** register.

Flash Memory Protection Read Enable (`DBG` field): If set to 0x2, access to the DAP is enabled through the JTAG and SWD interfaces. If clear, access to the DAP is disabled. The `DBG` field programming becomes permanent, and irreversible, after a commit sequence is performed.

In the initial state, provided from the factory, access is enabled in order to facilitate code development and debug. Access to the DAP may be disabled at the end of the manufacturing flow, once all tests have passed and software loaded. This change will not take effect until the next power-up of the device. Note that it is recommended that disabling access to the DAP be combined with a mechanism for providing end-user installable updates (if necessary) such as the Stellaris boot loader.

Important: Once the `DBG` field is cleared and committed, this field can never be restored to the factory-programmed value—which means JTAG/SWD interface to the debug module can never be re-enabled. This sequence does NOT disable the JTAG controller, it only disables the access of the DAP through the JTAG or SWD interfaces. The JTAG interface remains functional and access to the Test Access Port remains enabled, allowing the user to execute the IEEE JTAG-defined instructions (for example, to perform boundary scan operations).

If the user will also be using the **FMPRE** bits to protect flash memory from being read as data (to mark sets of 2 KB blocks of flash memory as execute-only), these one-time-programmable bits should be written at the same time that the debug disable bits are programmed. Mechanisms to execute the one-time code sequence to disable all debug access include:

- Selecting the debug disable option in the Stellaris boot loader
- Loading the debug disable sequence into SRAM and running it once from SRAM after programming the final end application code into flash

7.3 Flash Memory Initialization and Configuration

This section shows examples for using the flash controller to perform various operations on the contents of the flash memory.

7.3.1 Changing Flash Protection Bits

As discussed in “Flash Memory Protection” on page 109, changes to the protection bits must be committed before they take effect. The sequence below is used change and commit a block protection bit in the **FMPRE** or **FMPPE** registers. The sequence to change and commit a bit in software is as follows:

1. The **Flash Memory Protection Read Enable (FMPRE)** and **Flash Memory Protection Program Enable (FMPPE)** registers are written, changing the intended bit(s). The action of these changes can be tested by software while in this state.
2. The **Flash Memory Address (FMA)** register (see page 114) bit 0 is set to 1 if the **FMPPE** register is to be committed; otherwise, a 0 commits the **FMPRE** register.
3. The **Flash Memory Control (FMC)** register (see page 116) is written with the **COMT** bit set. This initiates a write sequence and commits the changes.

There is a special sequence to change and commit the **DBG** bits in the **Flash Memory Protection Read Enable (FMPRE)** register. This sequence also sets and commits any changes from 1 to 0 in the block protection bits (for execute-only) in the **FMPRE** register.

1. The **Flash Memory Protection Read Enable (FMPRE)** register is written, changing the intended bit(s). The action of these changes can be tested by software while in this state.
2. The **Flash Memory Address (FMA)** register (see page 114) is written with a value of 0x900.
3. The **Flash Memory Control (FMC)** register (see page 116) is written with the **COMT** bit set. This initiates a write sequence and commits the changes.

Below is an example code sequence to permanently disable the JTAG and SWD interface to the debug module using Luminary Micro's DriverLib peripheral driver library:

```
#include "hw_types.h"
#include "hw_flash.h"
void
permanently_disable_jtag_swd(void)
{
    //
    // Clear the DBG field of the FMPRE register. Note that the value
    // used in this instance does not affect the state of the BlockN
    // bits, but were the value different, all bits in the FMPRE are
    // affected by this function!
    //
    HWREG(FLASH_FMPRE) &= 0x3fffffff;
    //
    // The following sequence activates the one-time
    // programming of the FMPRE register.
    //
    HWREG(FLASH_FMA) = 0x900;
```

```

HWREG(FLASH_FMC) = (FLASH_FMC_WRKEY | FLASH_FMC_COMT);
//
// Wait until the operation is complete.
//
while (HWREG(FLASH_FMC) & FLASH_FMC_COMT)
{
}
}

```

7.3.2 Flash Programming

The Stellaris® devices provide a user-friendly interface for flash programming. All erase/program operations are handled via three registers: **FMA**, **FMD**, and **FMC**.

7.3.2.1 To program a 32-bit word

1. Write source data to the **FMD** register.
2. Write the target address to the **FMA** register.
3. Write the flash write key and the **WRITE** bit (a value of 0xA442.0001) to the **FMC** register.
4. Poll the **FMC** register until the **WRITE** bit is cleared.

7.3.2.2 To perform an erase of a 1-KB page

1. Write the page address to the **FMA** register.
2. Write the flash write key and the **ERASE** bit (a value of 0xA442.0002) to the **FMC** register.
3. Poll the **FMC** register until the **ERASE** bit is cleared.

7.3.2.3 To perform a mass erase of the flash

1. Write the flash write key and the **MERASE** bit (a value of 0xA442.0004) to the **FMC** register.
2. Poll the **FMC** register until the **MERASE** bit is cleared.

7.4 Register Map

Table 7-2 on page 112 lists the Flash memory and control registers. The offset listed is a hexadecimal increment to the register's address. The **FMA**, **FMD**, **FMC**, **FCRIS**, **FCIM**, and **FCMISC** registers are relative to the Flash control base address of 0x400F.D000. The **FMPREn**, **FMPPEn**, **USECRL**, **USER_DBG**, and **USER_REGn** registers are relative to the System Control base address of 0x400F.E000.

Table 7-2. Flash Register Map

Offset	Name	Type	Reset	Description	See page
Flash Registers (Flash Control Offset)					
0x000	FMA	R/W	0x0000.0000	Flash Memory Address	114
0x004	FMD	R/W	0x0000.0000	Flash Memory Data	115

Offset	Name	Type	Reset	Description	See page
0x008	FMC	R/W	0x0000.0000	Flash Memory Control	116
0x00C	FCRIS	RO	0x0000.0000	Flash Controller Raw Interrupt Status	118
0x010	FCIM	R/W	0x0000.0000	Flash Controller Interrupt Mask	119
0x014	FCMISC	R/W1C	0x0000.0000	Flash Controller Masked Interrupt Status and Clear	120
Flash Registers (System Control Offset)					
0x130	FMPRE	R/W	0xBFFF.FFFF	Flash Memory Protection Read Enable	122
0x134	FMPPE	R/W	0xFFFF.FFFF	Flash Memory Protection Program Enable	123
0x140	USECRL	R/W	0x31	USec Reload	121

7.5 Flash Register Descriptions (Flash Control Offset)

This section lists and describes the Flash Memory registers, in numerical order by address offset. Registers in this section are relative to the Flash control base address of 0x400F.D000.

Register 1: Flash Memory Address (FMA), offset 0x000

During a write operation, this register contains a 4-byte-aligned address and specifies where the data is written. During erase operations, this register contains a 1 KB-aligned address and specifies which page is erased. Note that the alignment requirements must be met by software or the results of the operation are unpredictable.

Flash Memory Address (FMA)

Base 0x400F.D000
 Offset 0x000
 Type R/W, reset 0x0000.0000

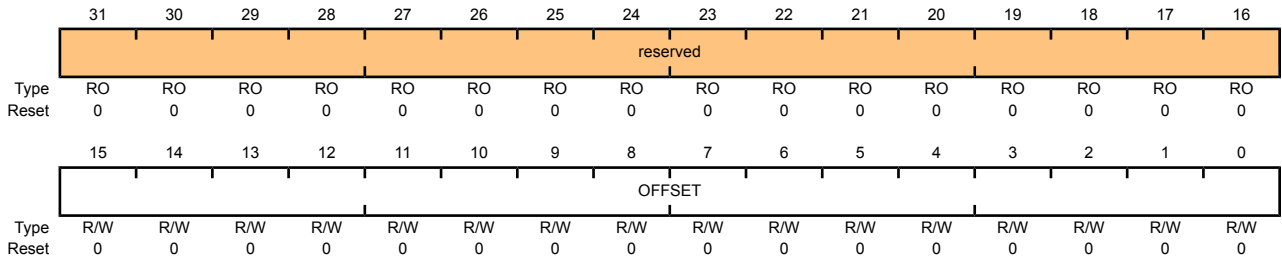

Bit/Field	Name	Type	Reset	Description
31:16	reserved	RO	0x0	Software should not rely on the value of a reserved bit. To provide compatibility with future products, the value of a reserved bit should be preserved across a read-modify-write operation.
15:0	OFFSET	R/W	0x0	Address Offset Address offset in flash where operation is performed.

Register 2: Flash Memory Data (FMD), offset 0x004

This register contains the data to be written during the programming cycle or read during the read cycle. Note that the contents of this register are undefined for a read access of an execute-only block. This register is not used during the erase cycles.

Flash Memory Data (FMD)

Base 0x400F.D000

Offset 0x004

Type R/W, reset 0x0000.0000

	31	30	29	28	27	26	25	24	23	22	21	20	19	18	17	16
	DATA															
Type	R/W	R/W	R/W	R/W	R/W	R/W	R/W	R/W	R/W	R/W	R/W	R/W	R/W	R/W	R/W	R/W
Reset	0	0	0	0	0	0	0	0	0	0	0	0	0	0	0	0
	15	14	13	12	11	10	9	8	7	6	5	4	3	2	1	0
	DATA															
Type	R/W	R/W	R/W	R/W	R/W	R/W	R/W	R/W	R/W	R/W	R/W	R/W	R/W	R/W	R/W	R/W
Reset	0	0	0	0	0	0	0	0	0	0	0	0	0	0	0	0

Bit/Field	Name	Type	Reset	Description
31:0	DATA	R/W	0x0	Data Value Data value for write operation.

Register 3: Flash Memory Control (FMC), offset 0x008

When this register is written, the flash controller initiates the appropriate access cycle for the location specified by the **Flash Memory Address (FMA)** register (see page 114). If the access is a write access, the data contained in the **Flash Memory Data (FMD)** register (see page 115) is written.

This is the final register written and initiates the memory operation. There are four control bits in the lower byte of this register that, when set, initiate the memory operation. The most used of these register bits are the `ERASE` and `WRITE` bits.

It is a programming error to write multiple control bits and the results of such an operation are unpredictable.

Flash Memory Control (FMC)

Base 0x400F.D000

Offset 0x008

Type R/W, reset 0x0000.0000

	31	30	29	28	27	26	25	24	23	22	21	20	19	18	17	16
	WRKEY															
Type	WO	WO	WO	WO	WO	WO	WO	WO	WO	WO	WO	WO	WO	WO	WO	WO
Reset	0	0	0	0	0	0	0	0	0	0	0	0	0	0	0	0
	15	14	13	12	11	10	9	8	7	6	5	4	3	2	1	0
	reserved												COMT	MERASE	ERASE	WRITE
Type	RO	RO	RO	RO	RO	RO	RO	RO	RO	RO	RO	RO	R/W	R/W	R/W	R/W
Reset	0	0	0	0	0	0	0	0	0	0	0	0	0	0	0	0

Bit/Field	Name	Type	Reset	Description
31:16	WRKEY	WO	0x0	Flash Write Key This field contains a write key, which is used to minimize the incidence of accidental flash writes. The value 0xA442 must be written into this field for a write to occur. Writes to the FMC register without this <code>WRKEY</code> value are ignored. A read of this field returns the value 0.
15:4	reserved	RO	0x0	Software should not rely on the value of a reserved bit. To provide compatibility with future products, the value of a reserved bit should be preserved across a read-modify-write operation.
3	COMT	R/W	0	Commit Register Value Commit (write) of register value to nonvolatile storage. A write of 0 has no effect on the state of this bit. If read, the state of the previous commit access is provided. If the previous commit access is complete, a 0 is returned; otherwise, if the commit access is not complete, a 1 is returned. This can take up to 50 μ s.
2	MERASE	R/W	0	Mass Erase Flash Memory If this bit is set, the flash main memory of the device is all erased. A write of 0 has no effect on the state of this bit. If read, the state of the previous mass erase access is provided. If the previous mass erase access is complete, a 0 is returned; otherwise, if the previous mass erase access is not complete, a 1 is returned. This can take up to 250 ms.

Bit/Field	Name	Type	Reset	Description
1	ERASE	R/W	0	<p>Erase a Page of Flash Memory</p> <p>If this bit is set, the page of flash main memory as specified by the contents of FMA is erased. A write of 0 has no effect on the state of this bit.</p> <p>If read, the state of the previous erase access is provided. If the previous erase access is complete, a 0 is returned; otherwise, if the previous erase access is not complete, a 1 is returned.</p> <p>This can take up to 25 ms.</p>
0	WRITE	R/W	0	<p>Write a Word into Flash Memory</p> <p>If this bit is set, the data stored in FMD is written into the location as specified by the contents of FMA. A write of 0 has no effect on the state of this bit.</p> <p>If read, the state of the previous write update is provided. If the previous write access is complete, a 0 is returned; otherwise, if the write access is not complete, a 1 is returned.</p> <p>This can take up to 50 μs.</p>

Register 4: Flash Controller Raw Interrupt Status (FCRIS), offset 0x00C

This register indicates that the flash controller has an interrupt condition. An interrupt is only signaled if the corresponding **FCIM** register bit is set.

Flash Controller Raw Interrupt Status (FCRIS)

Base 0x400F.D000

Offset 0x00C

Type RO, reset 0x0000.0000

	31	30	29	28	27	26	25	24	23	22	21	20	19	18	17	16	
	reserved																
Type	RO	RO	RO	RO	RO	RO	RO	RO	RO	RO	RO	RO	RO	RO	RO	RO	
Reset	0	0	0	0	0	0	0	0	0	0	0	0	0	0	0	0	
	15	14	13	12	11	10	9	8	7	6	5	4	3	2	1	0	
	reserved															PRIS	ARIS
Type	RO	RO	RO	RO	RO	RO	RO	RO	RO	RO	RO	RO	RO	RO	RO	RO	RO
Reset	0	0	0	0	0	0	0	0	0	0	0	0	0	0	0	0	0

Bit/Field	Name	Type	Reset	Description
31:2	reserved	RO	0x0	Software should not rely on the value of a reserved bit. To provide compatibility with future products, the value of a reserved bit should be preserved across a read-modify-write operation.
1	PRIS	RO	0	<p>Programming Raw Interrupt Status</p> <p>This bit indicates the current state of the programming cycle. If set, the programming cycle completed; if cleared, the programming cycle has not completed. Programming cycles are either write or erase actions generated through the Flash Memory Control (FMC) register bits (see page 116).</p>
0	ARIS	RO	0	<p>Access Raw Interrupt Status</p> <p>This bit indicates if the flash was improperly accessed. If set, the program tried to access the flash counter to the policy as set in the Flash Memory Protection Read Enable (FMPREn) and Flash Memory Protection Program Enable (FMPPEn) registers. Otherwise, no access has tried to improperly access the flash.</p>

Register 5: Flash Controller Interrupt Mask (FCIM), offset 0x010

This register controls whether the flash controller generates interrupts to the controller.

Flash Controller Interrupt Mask (FCIM)

Base 0x400F.D000

Offset 0x010

Type R/W, reset 0x0000.0000

	31	30	29	28	27	26	25	24	23	22	21	20	19	18	17	16	
	reserved																
Type	RO	RO	RO	RO	RO	RO	RO	RO	RO	RO	RO	RO	RO	RO	RO	RO	
Reset	0	0	0	0	0	0	0	0	0	0	0	0	0	0	0	0	
	15	14	13	12	11	10	9	8	7	6	5	4	3	2	1	0	
	reserved														PMASK	AMASK	
Type	RO	RO	RO	RO	RO	RO	RO	RO	RO	RO	RO	RO	RO	RO	RO	R/W	R/W
Reset	0	0	0	0	0	0	0	0	0	0	0	0	0	0	0	0	0

Bit/Field	Name	Type	Reset	Description
31:2	reserved	RO	0x0	Software should not rely on the value of a reserved bit. To provide compatibility with future products, the value of a reserved bit should be preserved across a read-modify-write operation.
1	PMASK	R/W	0	<p>Programming Interrupt Mask</p> <p>This bit controls the reporting of the programming raw interrupt status to the controller. If set, a programming-generated interrupt is promoted to the controller. Otherwise, interrupts are recorded but suppressed from the controller.</p>
0	AMASK	R/W	0	<p>Access Interrupt Mask</p> <p>This bit controls the reporting of the access raw interrupt status to the controller. If set, an access-generated interrupt is promoted to the controller. Otherwise, interrupts are recorded but suppressed from the controller.</p>

Register 6: Flash Controller Masked Interrupt Status and Clear (FCMISC), offset 0x014

This register provides two functions. First, it reports the cause of an interrupt by indicating which interrupt source or sources are signalling the interrupt. Second, it serves as the method to clear the interrupt reporting.

Flash Controller Masked Interrupt Status and Clear (FCMISC)

Base 0x400F.D000

Offset 0x014

Type R/W1C, reset 0x0000.0000

	31	30	29	28	27	26	25	24	23	22	21	20	19	18	17	16
	reserved															
Type	RO	RO	RO	RO	RO	RO	RO	RO	RO	RO	RO	RO	RO	RO	RO	RO
Reset	0	0	0	0	0	0	0	0	0	0	0	0	0	0	0	0
	15	14	13	12	11	10	9	8	7	6	5	4	3	2	1	0
	reserved														PMISC	AMISC
Type	RO	RO	RO	RO	RO	RO	RO	RO	RO	RO	RO	RO	RO	RO	R/W1C	R/W1C
Reset	0	0	0	0	0	0	0	0	0	0	0	0	0	0	0	0

Bit/Field	Name	Type	Reset	Description
31:2	reserved	RO	0x0	Software should not rely on the value of a reserved bit. To provide compatibility with future products, the value of a reserved bit should be preserved across a read-modify-write operation.
1	PMISC	R/W1C	0	Programming Masked Interrupt Status and Clear This bit indicates whether an interrupt was signaled because a programming cycle completed and was not masked. This bit is cleared by writing a 1. The <code>PRIS</code> bit in the <code>FCRIS</code> register (see page 118) is also cleared when the <code>PMISC</code> bit is cleared.
0	AMISC	R/W1C	0	Access Masked Interrupt Status and Clear This bit indicates whether an interrupt was signaled because an improper access was attempted and was not masked. This bit is cleared by writing a 1. The <code>ARIS</code> bit in the <code>FCRIS</code> register is also cleared when the <code>AMISC</code> bit is cleared.

7.6 Flash Register Descriptions (System Control Offset)

The remainder of this section lists and describes the Flash Memory registers, in numerical order by address offset. Registers in this section are relative to the System Control base address of 0x400F.E000.

Register 7: USec Reload (USECRL), offset 0x140

Note: Offset is relative to System Control base address of 0x400F.E000

This register is provided as a means of creating a 1- μ s tick divider reload value for the flash controller. The internal flash has specific minimum and maximum requirements on the length of time the high voltage write pulse can be applied. It is required that this register contain the operating frequency (in MHz -1) whenever the flash is being erased or programmed. The user is required to change this value if the clocking conditions are changed for a flash erase/program operation.

USec Reload (USECRL)

Base 0x400F.E000

Offset 0x140

Type R/W, reset 0x31

	31	30	29	28	27	26	25	24	23	22	21	20	19	18	17	16
	reserved															
Type	RO	RO	RO	RO	RO	RO	RO	RO	RO	RO	RO	RO	RO	RO	RO	RO
Reset	0	0	0	0	0	0	0	0	0	0	0	0	0	0	0	0
	15	14	13	12	11	10	9	8	7	6	5	4	3	2	1	0
	reserved								USEC							
Type	RO	RO	RO	RO	RO	RO	RO	RO	R/W	R/W	R/W	R/W	R/W	R/W	R/W	R/W
Reset	0	0	0	0	0	0	0	0	0	0	1	1	0	0	0	1

Bit/Field	Name	Type	Reset	Description
31:8	reserved	RO	0x0	Software should not rely on the value of a reserved bit. To provide compatibility with future products, the value of a reserved bit should be preserved across a read-modify-write operation.
7:0	USEC	R/W	0x31	Microsecond Reload Value MHz -1 of the controller clock when the flash is being erased or programmed. If the maximum system frequency is being used, USEC should be set to 0x31 (50 MHz) whenever the flash is being erased or programmed.

Register 8: Flash Memory Protection Read Enable (FMPRE), offset 0x130

Note: Offset is relative to System Control base address of 0x400FE000.

This register stores the read-only protection bits for each 2-KB flash block (see the **FMPPE** registers for the execute-only protection bits). This register is loaded during the power-on reset sequence. The factory settings are a value of 1 for all implemented banks. This implements a policy of open access and programmability. The register bits may be changed by writing the specific register bit. However, this register is R/W0; the user can only change the protection bit from a 1 to a 0 (and may NOT change a 0 to a 1). The changes are not permanent until the register is committed (saved), at which point the bit change is permanent. If a bit is changed from a 1 to a 0 and not committed, it may be restored by executing a power-on reset sequence. For additional information, see the “Flash Memory Protection” section.

Flash Memory Protection Read Enable (FMPRE)

Base 0x400F.E000
 Offset 0x130
 Type R/W, reset 0xBFFF.FFFF

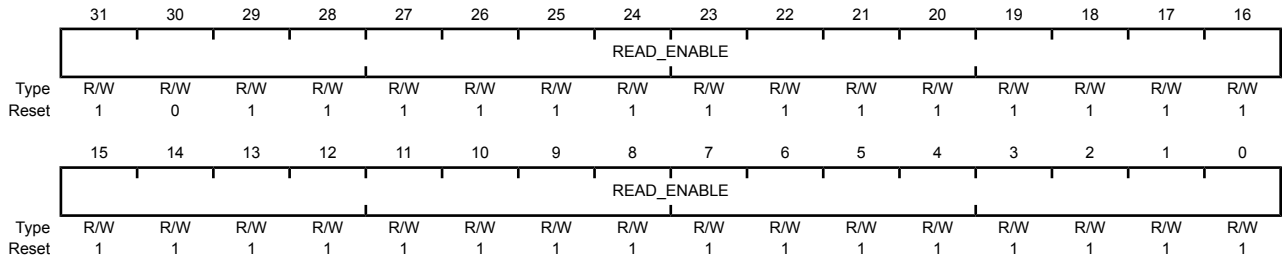

Bit/Field	Name	Type	Reset	Description
31:0	READ_ENABLE	R/W	0xBFFFFFFF	Flash Read Enable Each bit position maps 2 Kbytes of Flash to be read-enabled.
				Value Description 0xBFFFFFFF Enables 64 KB of flash.

Register 9: Flash Memory Protection Program Enable (FMPPE), offset 0x134

Note: Offset is relative to System Control base address of 0x400FE000.

This register stores the execute-only protection bits for each 2-KB flash block (see the **FMPRE** registers for the read-only protection bits). This register is loaded during the power-on reset sequence. The factory settings are a value of 1 for all implemented banks. This implements a policy of open access and programmability. The register bits may be changed by writing the specific register bit. However, this register is R/W0; the user can only change the protection bit from a 1 to a 0 (and may NOT change a 0 to a 1). The changes are not permanent until the register is committed (saved), at which point the bit change is permanent. If a bit is changed from a 1 to a 0 and not committed, it may be restored by executing a power-on reset sequence. For additional information, see the “Flash Memory Protection” section.

Flash Memory Protection Program Enable (FMPPE)

Base 0x400F.E000
 Offset 0x134
 Type R/W, reset 0xFFFF.FFFF

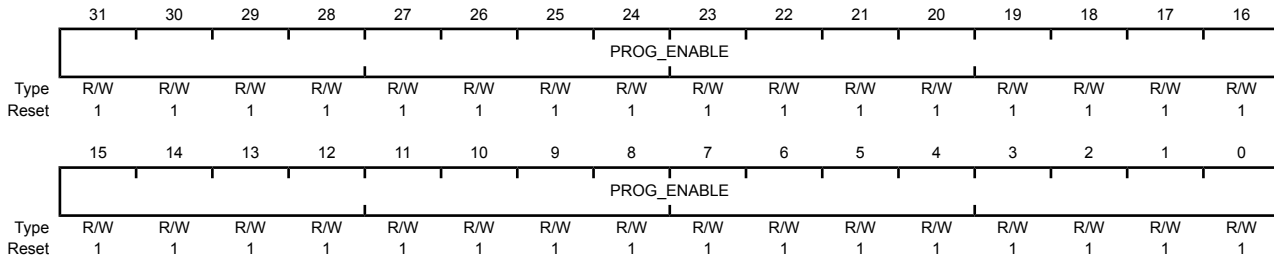

Bit/Field	Name	Type	Reset	Description
31:0	PROG_ENABLE	R/W	0xFFFFFFFF	Flash Programming Enable Each bit position maps 2 Kbytes of Flash to be write-enabled.
	Value		Description	
	0xFFFFFFFF		Enables 64 KB of flash.	

8 General-Purpose Input/Outputs (GPIOs)

The GPIO module is composed of five physical GPIO blocks, each corresponding to an individual GPIO port (Port A, Port B, Port C, Port D, and Port E,). The GPIO module supports 7-28 programmable input/output pins, depending on the peripherals being used.

The GPIO module has the following features:

- Programmable control for GPIO interrupts
 - Interrupt generation masking
 - Edge-triggered on rising, falling, or both
 - Level-sensitive on High or Low values
- 5-V-tolerant input/outputs
- Bit masking in both read and write operations through address lines
- Pins configured as digital inputs are Schmitt-triggered.
- Programmable control for GPIO pad configuration:
 - Weak pull-up or pull-down resistors
 - 2-mA, 4-mA, and 8-mA pad drive for digital communication
 - Slew rate control for the 8-mA drive
 - Open drain enables
 - Digital input enables

8.1 Block Diagram

Figure 8-1. GPIO Module Block Diagram

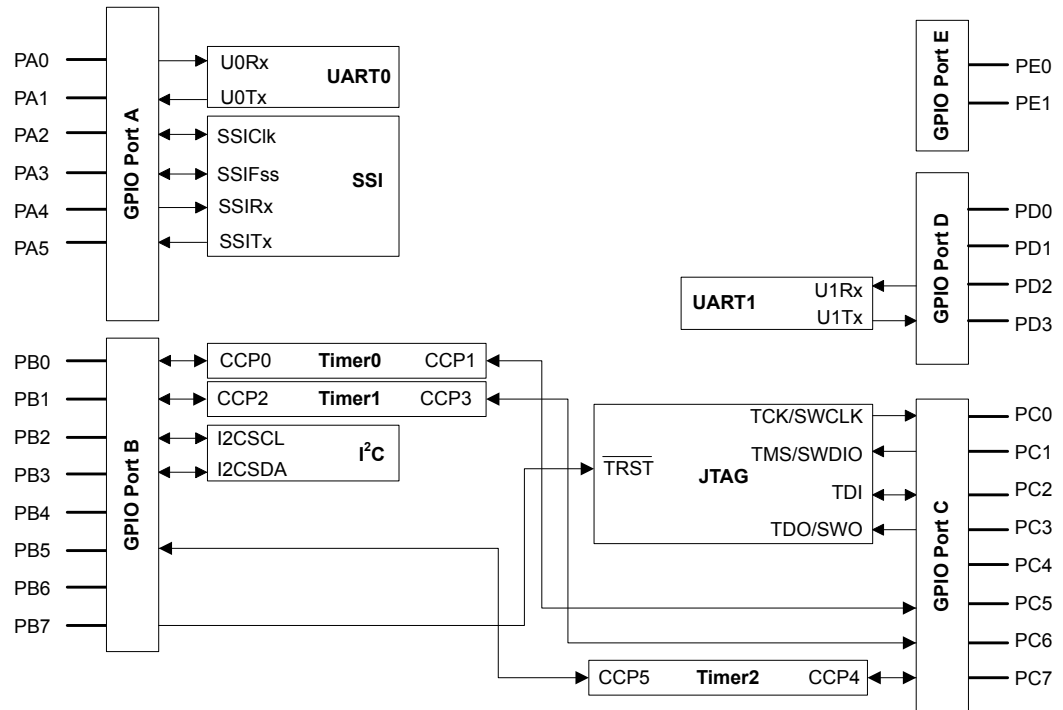

8.2 Functional Description

Important: All GPIO pins are inputs by default ($\text{GPIODIR}=0$ and $\text{GPIOAFSEL}=0$), with the exception of the five JTAG pins (PB7 and $\text{PC}[3:0]$). The JTAG pins default to their JTAG functionality ($\text{GPIOAFSEL}=1$). A Power-On-Reset ($\overline{\text{POR}}$) or asserting an external reset ($\overline{\text{RST}}$) puts both groups of pins back to their default state.

Each GPIO port is a separate hardware instantiation of the same physical block (see Figure 8-2 on page 126). The LM3S828 microcontroller contains five ports and thus five of these physical GPIO blocks.

Figure 8-2. GPIO Port Block Diagram

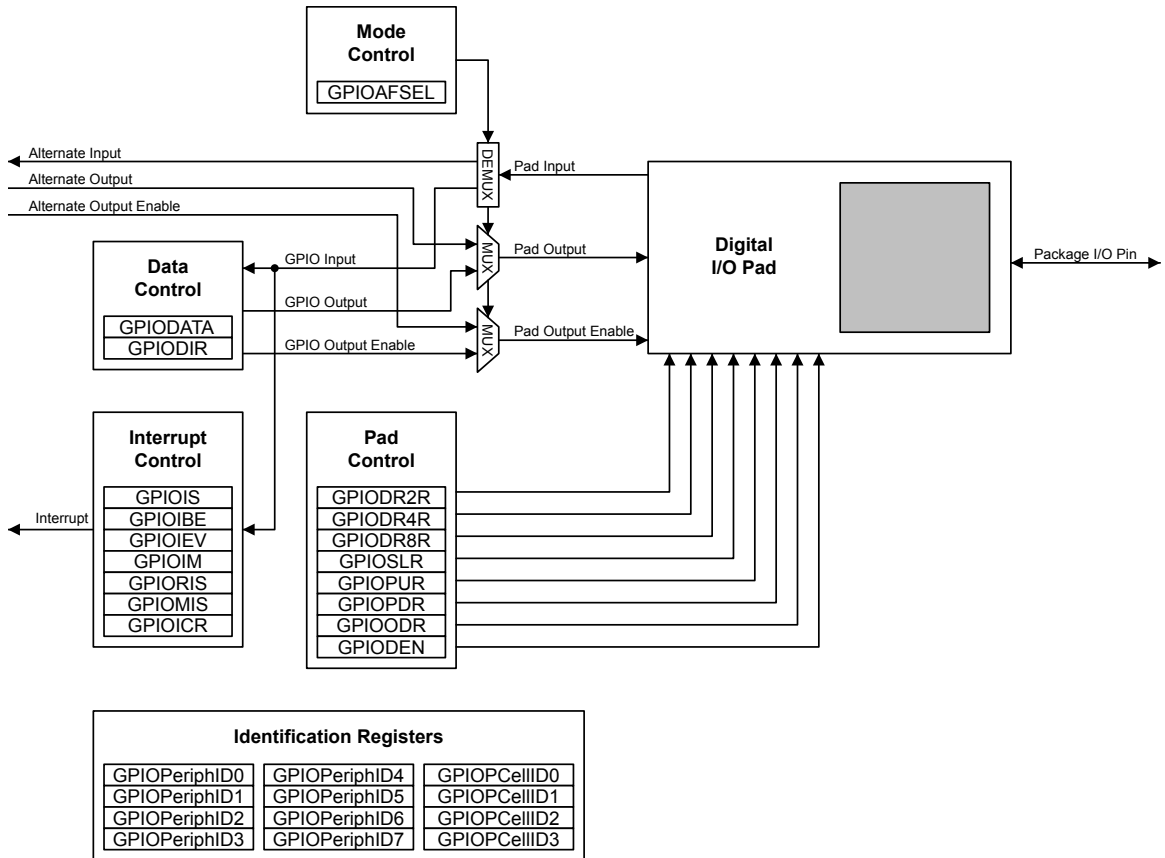

8.2.1 Data Control

The data control registers allow software to configure the operational modes of the GPIOs. The data direction register configures the GPIO as an input or an output while the data register either captures incoming data or drives it out to the pads.

8.2.1.1 Data Direction Operation

The **GPIO Direction (GPIODIR)** register (see page 133) is used to configure each individual pin as an input or output. When the data direction bit is set to 0, the GPIO is configured as an input and the corresponding data register bit will capture and store the value on the GPIO port. When the data direction bit is set to 1, the GPIO is configured as an output and the corresponding data register bit will be driven out on the GPIO port.

8.2.1.2 Data Register Operation

To aid in the efficiency of software, the GPIO ports allow for the modification of individual bits in the **GPIO Data (GPIODATA)** register (see page 132) by using bits [9:2] of the address bus as a mask. This allows software drivers to modify individual GPIO pins in a single instruction, without affecting the state of the other pins. This is in contrast to the "typical" method of doing a read-modify-write operation to set or clear an individual GPIO pin. To accommodate this feature, the **GPIODATA** register covers 256 locations in the memory map.

During a write, if the address bit associated with that data bit is set to 1, the value of the **GPIODATA** register is altered. If it is cleared to 0, it is left unchanged.

For example, writing a value of 0xEB to the address GPIODATA + 0x098 would yield as shown in Figure 8-3 on page 127, where *u* is data unchanged by the write.

Figure 8-3. GPIODATA Write Example

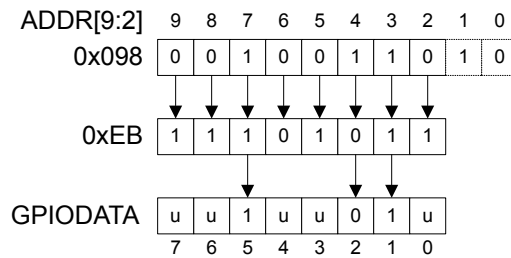

During a read, if the address bit associated with the data bit is set to 1, the value is read. If the address bit associated with the data bit is set to 0, it is read as a zero, regardless of its actual value. For example, reading address GPIODATA + 0x0C4 yields as shown in Figure 8-4 on page 127.

Figure 8-4. GPIODATA Read Example

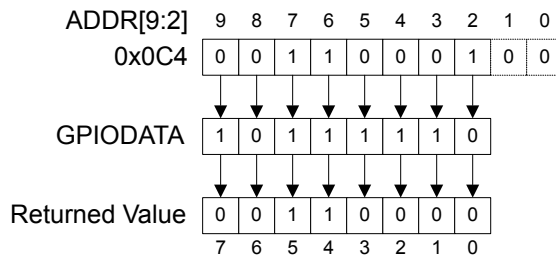

8.2.2 Interrupt Control

The interrupt capabilities of each GPIO port are controlled by a set of seven registers. With these registers, it is possible to select the source of the interrupt, its polarity, and the edge properties. When one or more GPIO inputs cause an interrupt, a single interrupt output is sent to the interrupt controller for the entire GPIO port. For edge-triggered interrupts, software must clear the interrupt to enable any further interrupts. For a level-sensitive interrupt, it is assumed that the external source holds the level constant for the interrupt to be recognized by the controller.

Three registers are required to define the edge or sense that causes interrupts:

- **GPIO Interrupt Sense (GPIOIS)** register (see page 134)
- **GPIO Interrupt Both Edges (GPIOIBE)** register (see page 135)
- **GPIO Interrupt Event (GPIOIEV)** register (see page 136)

Interrupts are enabled/disabled via the **GPIO Interrupt Mask (GPIOIM)** register (see page 137).

When an interrupt condition occurs, the state of the interrupt signal can be viewed in two locations: the **GPIO Raw Interrupt Status (GPIORIS)** and **GPIO Masked Interrupt Status (GPIOMIS)** registers (see page 138 and page 139). As the name implies, the **GPIOMIS** register only shows interrupt conditions that are allowed to be passed to the controller. The **GPIORIS** register indicates that a GPIO pin meets the conditions for an interrupt, but has not necessarily been sent to the controller.

In addition to providing GPIO functionality, PB4 can also be used as an external trigger for the ADC. If PB4 is configured as a non-masked interrupt pin (the appropriate bit of GPIOIM is set to 1), not only is an interrupt for PortB generated, but an external trigger signal is sent to the ADC. If the **ADC Event Multiplexer Select (ADCEMUX)** register is configured to use the external trigger, an ADC conversion is initiated.

If no other PortB pins are being used to generate interrupts, the ARM Integrated Nested Vectored Interrupt Controller (NVIC) Interrupt Set Enable (SETNA) register can disable the PortB interrupts and the ADC interrupt can be used to read back the converted data. Otherwise, the PortB interrupt handler needs to ignore and clear interrupts on B4, and wait for the ADC interrupt or the ADC interrupt needs to be disabled in the SETNA register and the PortB interrupt handler polls the ADC registers until the conversion is completed.

Interrupts are cleared by writing a 1 to the appropriate bit of the **GPIO Interrupt Clear (GPIOICR)** register (see page 140).

When programming the following interrupt control registers, the interrupts should be masked (GPIOIM set to 0). Writing any value to an interrupt control register (GPIOIS, GPIOIBE, or GPIOIEV) can generate a spurious interrupt if the corresponding bits are enabled.

8.2.3 Mode Control

The GPIO pins can be controlled by either hardware or software. When hardware control is enabled via the **GPIO Alternate Function Select (GPIOAFSEL)** register (see page 141), the pin state is controlled by its alternate function (that is, the peripheral). Software control corresponds to GPIO mode, where the **GPIODATA** register is used to read/write the corresponding pins.

8.2.4 Pad Control

The pad control registers allow for GPIO pad configuration by software based on the application requirements. The pad control registers include the **GPIODR2R, GPIODR4R, GPIODR8R, GPIOODR, GPIOPUR, GPIOPDR, GPIOSLR, and GPIODEN** registers. These registers control drive strength, open-drain configuration, pull-up and pull-down resistors, slew-rate control and digital input enable.

8.2.5 Identification

The identification registers configured at reset allow software to detect and identify the module as a GPIO block. The identification registers include the **GPIOPeriphID0-GIOPeriphID7** registers as well as the **GPIOCellID0-GIOPCellID3** registers.

8.3 Initialization and Configuration

To use the GPIO, the peripheral clock must be enabled by setting the appropriate GPIO Port bit field (GPIO_n) in the **RCGC2** register.

On reset, all GPIO pins (except for the five JTAG pins) default to general-purpose input mode (GPIO_{DIR}=0 and GPIO_{AFSEL}=0). Table 8-1 on page 128 shows all possible configurations of the GPIO pads and the control register settings required to achieve them. Table 8-2 on page 129 shows how a rising edge interrupt would be configured for pin 2 of a GPIO port.

Table 8-1. GPIO Pad Configuration Examples

Configuration	GPIO Register Bit Value ^a									
	AFSEL	DIR	ODR	DEN	PUR	PDR	DR2R	DR4R	DR8R	SLR
Digital Input (GPIO)	0	0	0	1	?	?	X	X	X	X
Digital Output (GPIO)	0	1	0	1	?	?	?	?	?	?

Configuration	GPIO Register Bit Value ^a									
	AFSEL	DIR	ODR	DEN	PUR	PDR	DR2R	DR4R	DR8R	SLR
Open Drain Input (GPIO)	0	0	1	1	X	X	X	X	X	X
Open Drain Output (GPIO)	0	1	1	1	X	X	?	?	?	?
Open Drain Input/Output (I ² C)	1	X	1	1	X	X	?	?	?	?
Digital Input (Timer CCP)	1	X	0	1	?	?	X	X	X	X
Digital Output (Timer PWM)	1	X	0	1	?	?	?	?	?	?
Digital Input/Output (SSI)	1	X	0	1	?	?	?	?	?	?
Digital Input/Output (UART)	1	X	0	1	?	?	?	?	?	?

a. X=Ignored (don't care bit)

?=Can be either 0 or 1, depending on the configuration

Table 8-2. GPIO Interrupt Configuration Example

Register	Desired Interrupt Event Trigger	Pin 2 Bit Value ^a							
		7	6	5	4	3	2	1	0
GPIOIS	0=edge 1=level	X	X	X	X	X	0	X	X
GPIOIBE	0=single edge 1=both edges	X	X	X	X	X	0	X	X
GPIOIEV	0=Low level, or negative edge 1=High level, or positive edge	X	X	X	X	X	1	X	X
GPIOIM	0=masked 1=not masked	0	0	0	0	0	1	0	0

a. X=Ignored (don't care bit)

8.4 Register Map

Table 8-3 on page 130 lists the GPIO registers. The offset listed is a hexadecimal increment to the register's address, relative to that GPIO port's base address:

- GPIO Port A: 0x4000.4000
- GPIO Port B: 0x4000.5000
- GPIO Port C: 0x4000.6000

- GPIO Port D: 0x4000.7000
- GPIO Port E: 0x4002.4000

Important: The GPIO registers in this chapter are duplicated in each GPIO block, however, depending on the block, all eight bits may not be connected to a GPIO pad. In those cases, writing to those unconnected bits has no effect and reading those unconnected bits returns no meaningful data.

Note: The default reset value for the **GPIOAFSEL** register is 0x0000.0000 for all GPIO pins, with the exception of the five JTAG pins ($PB7$ and $PC[3:0]$). These five pins default to JTAG functionality. Because of this, the default reset value of **GPIOAFSEL** for GPIO Port B is 0x0000.0080 while the default reset value for Port C is 0x0000.000F.

Table 8-3. GPIO Register Map

Offset	Name	Type	Reset	Description	See page
0x000	GPIODATA	R/W	0x0000.0000	GPIO Data	132
0x400	GPIODIR	R/W	0x0000.0000	GPIO Direction	133
0x404	GPIOIS	R/W	0x0000.0000	GPIO Interrupt Sense	134
0x408	GPIOIBE	R/W	0x0000.0000	GPIO Interrupt Both Edges	135
0x40C	GPIOIEV	R/W	0x0000.0000	GPIO Interrupt Event	136
0x410	GPIOIM	R/W	0x0000.0000	GPIO Interrupt Mask	137
0x414	GPIORIS	RO	0x0000.0000	GPIO Raw Interrupt Status	138
0x418	GIOMIS	RO	0x0000.0000	GPIO Masked Interrupt Status	139
0x41C	GPIOICR	W1C	0x0000.0000	GPIO Interrupt Clear	140
0x420	GPIOAFSEL	R/W	-	GPIO Alternate Function Select	141
0x500	GPIODR2R	R/W	0x0000.00FF	GPIO 2-mA Drive Select	143
0x504	GPIODR4R	R/W	0x0000.0000	GPIO 4-mA Drive Select	144
0x508	GPIODR8R	R/W	0x0000.0000	GPIO 8-mA Drive Select	145
0x50C	GPIOODR	R/W	0x0000.0000	GPIO Open Drain Select	146
0x510	GIOPUR	R/W	0x0000.00FF	GPIO Pull-Up Select	147
0x514	GIOPDR	R/W	0x0000.0000	GPIO Pull-Down Select	148
0x518	GPIOSLR	R/W	0x0000.0000	GPIO Slew Rate Control Select	149
0x51C	GIODEN	R/W	0x0000.00FF	GPIO Digital Enable	150
0xFD0	GPIOPeriphID4	RO	0x0000.0000	GPIO Peripheral Identification 4	151
0xFD4	GPIOPeriphID5	RO	0x0000.0000	GPIO Peripheral Identification 5	152
0xFD8	GPIOPeriphID6	RO	0x0000.0000	GPIO Peripheral Identification 6	153
0xFDC	GPIOPeriphID7	RO	0x0000.0000	GPIO Peripheral Identification 7	154
0xFE0	GPIOPeriphID0	RO	0x0000.0061	GPIO Peripheral Identification 0	155

Offset	Name	Type	Reset	Description	See page
0xFE4	GPIOPeriphID1	RO	0x0000.0000	GPIO Peripheral Identification 1	156
0xFE8	GPIOPeriphID2	RO	0x0000.0018	GPIO Peripheral Identification 2	157
0xFEC	GPIOPeriphID3	RO	0x0000.0001	GPIO Peripheral Identification 3	158
0xFF0	GPIOCellID0	RO	0x0000.000D	GPIO PrimeCell Identification 0	159
0xFF4	GPIOCellID1	RO	0x0000.00F0	GPIO PrimeCell Identification 1	160
0xFF8	GPIOCellID2	RO	0x0000.0005	GPIO PrimeCell Identification 2	161
0xFFC	GPIOCellID3	RO	0x0000.00B1	GPIO PrimeCell Identification 3	162

8.5 Register Descriptions

The remainder of this section lists and describes the GPIO registers, in numerical order by address offset.

Register 1: GPIO Data (GPIODATA), offset 0x000

The **GPIODATA** register is the data register. In software control mode, values written in the **GPIODATA** register are transferred onto the GPIO port pins if the respective pins have been configured as outputs through the **GPIO Direction (GPIODIR)** register (see page 133).

In order to write to **GPIODATA**, the corresponding bits in the mask, resulting from the address bus bits [9:2], must be High. Otherwise, the bit values remain unchanged by the write.

Similarly, the values read from this register are determined for each bit by the mask bit derived from the address used to access the data register, bits [9:2]. Bits that are 1 in the address mask cause the corresponding bits in **GPIODATA** to be read, and bits that are 0 in the address mask cause the corresponding bits in **GPIODATA** to be read as 0, regardless of their value.

A read from **GPIODATA** returns the last bit value written if the respective pins are configured as outputs, or it returns the value on the corresponding input pin when these are configured as inputs. All bits are cleared by a reset.

GPIO Data (GPIODATA)

GPIO Port A base: 0x4000.4000
 GPIO Port B base: 0x4000.5000
 GPIO Port C base: 0x4000.6000
 GPIO Port D base: 0x4000.7000
 GPIO Port E base: 0x4002.4000
 Offset 0x000
 Type R/W, reset 0x0000.0000

	31	30	29	28	27	26	25	24	23	22	21	20	19	18	17	16
	reserved															
Type	RO	RO	RO	RO	RO	RO	RO	RO	RO	RO	RO	RO	RO	RO	RO	RO
Reset	0	0	0	0	0	0	0	0	0	0	0	0	0	0	0	0
	15	14	13	12	11	10	9	8	7	6	5	4	3	2	1	0
	reserved								DATA							
Type	RO	RO	RO	RO	RO	RO	RO	RO	R/W	R/W	R/W	R/W	R/W	R/W	R/W	R/W
Reset	0	0	0	0	0	0	0	0	0	0	0	0	0	0	0	0

Bit/Field	Name	Type	Reset	Description
31:8	reserved	RO	0x00	Software should not rely on the value of a reserved bit. To provide compatibility with future products, the value of a reserved bit should be preserved across a read-modify-write operation.
7:0	DATA	R/W	0x00	GPIO Data

This register is virtually mapped to 256 locations in the address space. To facilitate the reading and writing of data to these registers by independent drivers, the data read from and the data written to the registers are masked by the eight address lines `ipaddr[9:2]`. Reads from this register return its current state. Writes to this register only affect bits that are not masked by `ipaddr[9:2]` and are configured as outputs. See "Data Register Operation" on page 126 for examples of reads and writes.

Register 2: GPIO Direction (GPIODIR), offset 0x400

The **GPIODIR** register is the data direction register. Bits set to 1 in the **GPIODIR** register configure the corresponding pin to be an output, while bits set to 0 configure the pins to be inputs. All bits are cleared by a reset, meaning all GPIO pins are inputs by default.

GPIO Direction (GPIODIR)

GPIO Port A base: 0x4000.4000

GPIO Port B base: 0x4000.5000

GPIO Port C base: 0x4000.6000

GPIO Port D base: 0x4000.7000

GPIO Port E base: 0x4002.4000

Offset 0x400

Type R/W, reset 0x0000.0000

	31	30	29	28	27	26	25	24	23	22	21	20	19	18	17	16
	reserved															
Type	RO	RO	RO	RO	RO	RO	RO	RO	RO	RO	RO	RO	RO	RO	RO	RO
Reset	0	0	0	0	0	0	0	0	0	0	0	0	0	0	0	0
	15	14	13	12	11	10	9	8	7	6	5	4	3	2	1	0
	reserved								DIR							
Type	RO	RO	RO	RO	RO	RO	RO	RO	R/W	R/W	R/W	R/W	R/W	R/W	R/W	R/W
Reset	0	0	0	0	0	0	0	0	0	0	0	0	0	0	0	0

Bit/Field	Name	Type	Reset	Description
31:8	reserved	RO	0x00	Software should not rely on the value of a reserved bit. To provide compatibility with future products, the value of a reserved bit should be preserved across a read-modify-write operation.
7:0	DIR	R/W	0x00	GPIO Data Direction

The **DIR** values are defined as follows:

Value	Description
0	Pins are inputs.
1	Pins are outputs.

Register 3: GPIO Interrupt Sense (GPIOIS), offset 0x404

The **GPIOIS** register is the interrupt sense register. Bits set to 1 in **GPIOIS** configure the corresponding pins to detect levels, while bits set to 0 configure the pins to detect edges. All bits are cleared by a reset.

GPIO Interrupt Sense (GPIOIS)

GPIO Port A base: 0x4000.4000
 GPIO Port B base: 0x4000.5000
 GPIO Port C base: 0x4000.6000
 GPIO Port D base: 0x4000.7000
 GPIO Port E base: 0x4002.4000
 Offset 0x404
 Type R/W, reset 0x0000.0000

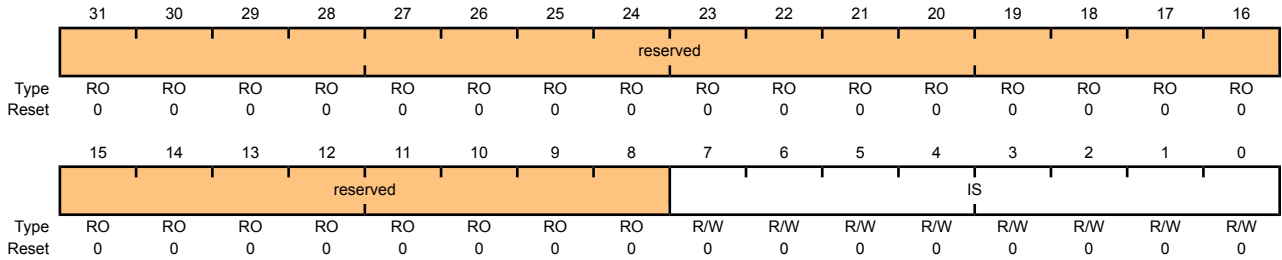

Bit/Field	Name	Type	Reset	Description
31:8	reserved	RO	0x00	Software should not rely on the value of a reserved bit. To provide compatibility with future products, the value of a reserved bit should be preserved across a read-modify-write operation.
7:0	IS	R/W	0x00	GPIO Interrupt Sense

The IS values are defined as follows:

Value	Description
0	Edge on corresponding pin is detected (edge-sensitive).
1	Level on corresponding pin is detected (level-sensitive).

Register 4: GPIO Interrupt Both Edges (GPIOIBE), offset 0x408

The **GPIOIBE** register is the interrupt both-edges register. When the corresponding bit in the **GPIO Interrupt Sense (GPIOIS)** register (see page 134) is set to detect edges, bits set to High in **GPIOIBE** configure the corresponding pin to detect both rising and falling edges, regardless of the corresponding bit in the **GPIO Interrupt Event (GPIOIEV)** register (see page 136). Clearing a bit configures the pin to be controlled by **GPIOIEV**. All bits are cleared by a reset.

GPIO Interrupt Both Edges (GPIOIBE)

GPIO Port A base: 0x4000.4000
 GPIO Port B base: 0x4000.5000
 GPIO Port C base: 0x4000.6000
 GPIO Port D base: 0x4000.7000
 GPIO Port E base: 0x4002.4000
 Offset 0x408
 Type R/W, reset 0x0000.0000

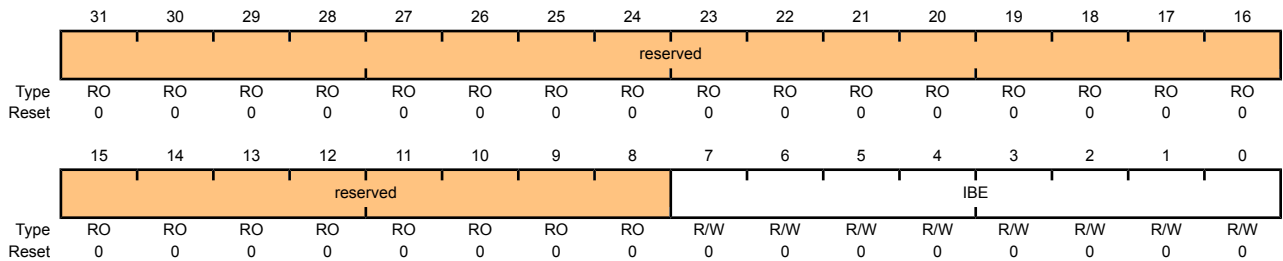

Bit/Field	Name	Type	Reset	Description
31:8	reserved	RO	0x00	Software should not rely on the value of a reserved bit. To provide compatibility with future products, the value of a reserved bit should be preserved across a read-modify-write operation.
7:0	IBE	R/W	0x00	GPIO Interrupt Both Edges

The IBE values are defined as follows:

- | | |
|-------|--|
| Value | Description |
| 0 | Interrupt generation is controlled by the GPIO Interrupt Event (GPIOIEV) register (see page 136). |
| 1 | Both edges on the corresponding pin trigger an interrupt. |

Note: Single edge is determined by the corresponding bit in **GPIOIEV**.

Register 5: GPIO Interrupt Event (GPIOIEV), offset 0x40C

The **GPIOIEV** register is the interrupt event register. Bits set to High in **GPIOIEV** configure the corresponding pin to detect rising edges or high levels, depending on the corresponding bit value in the **GPIO Interrupt Sense (GPIOIS)** register (see page 134). Clearing a bit configures the pin to detect falling edges or low levels, depending on the corresponding bit value in **GPIOIS**. All bits are cleared by a reset.

GPIO Interrupt Event (GPIOIEV)

GPIO Port A base: 0x4000.4000
 GPIO Port B base: 0x4000.5000
 GPIO Port C base: 0x4000.6000
 GPIO Port D base: 0x4000.7000
 GPIO Port E base: 0x4002.4000
 Offset 0x40C
 Type R/W, reset 0x0000.0000

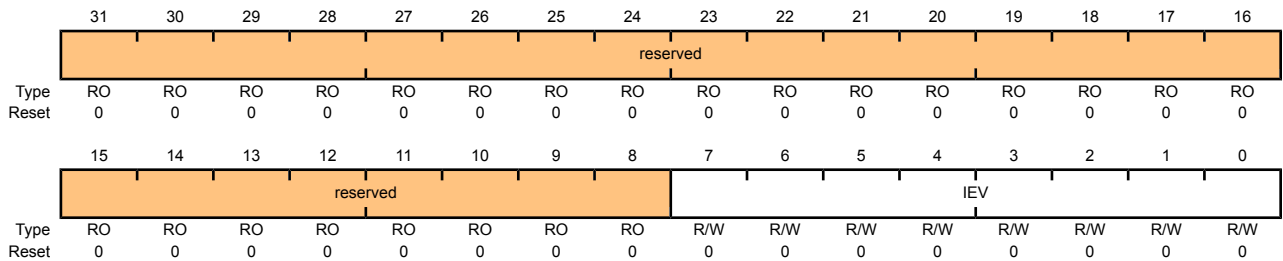

Bit/Field	Name	Type	Reset	Description
31:8	reserved	RO	0x00	Software should not rely on the value of a reserved bit. To provide compatibility with future products, the value of a reserved bit should be preserved across a read-modify-write operation.
7:0	IEV	R/W	0x00	GPIO Interrupt Event

The **IEV** values are defined as follows:

Value	Description
0	Falling edge or Low levels on corresponding pins trigger interrupts.
1	Rising edge or High levels on corresponding pins trigger interrupts.

Register 6: GPIO Interrupt Mask (GPIOIM), offset 0x410

The **GPIOIM** register is the interrupt mask register. Bits set to High in **GPIOIM** allow the corresponding pins to trigger their individual interrupts and the combined **GPIOINTR** line. Clearing a bit disables interrupt triggering on that pin. All bits are cleared by a reset.

GPIO Interrupt Mask (GPIOIM)

GPIO Port A base: 0x4000.4000

GPIO Port B base: 0x4000.5000

GPIO Port C base: 0x4000.6000

GPIO Port D base: 0x4000.7000

GPIO Port E base: 0x4002.4000

Offset 0x410

Type R/W, reset 0x0000.0000

	31	30	29	28	27	26	25	24	23	22	21	20	19	18	17	16
	reserved															
Type	RO	RO	RO	RO	RO	RO	RO	RO	RO	RO	RO	RO	RO	RO	RO	RO
Reset	0	0	0	0	0	0	0	0	0	0	0	0	0	0	0	0
	15	14	13	12	11	10	9	8	7	6	5	4	3	2	1	0
	reserved								IME							
Type	RO	RO	RO	RO	RO	RO	RO	RO	R/W	R/W	R/W	R/W	R/W	R/W	R/W	R/W
Reset	0	0	0	0	0	0	0	0	0	0	0	0	0	0	0	0

Bit/Field	Name	Type	Reset	Description
31:8	reserved	RO	0x00	Software should not rely on the value of a reserved bit. To provide compatibility with future products, the value of a reserved bit should be preserved across a read-modify-write operation.
7:0	IME	R/W	0x00	GPIO Interrupt Mask Enable

The **IME** values are defined as follows:

Value Description

- 0 Corresponding pin interrupt is masked.
- 1 Corresponding pin interrupt is not masked.

Register 7: GPIO Raw Interrupt Status (GPIORIS), offset 0x414

The **GPIORIS** register is the raw interrupt status register. Bits read High in **GPIORIS** reflect the status of interrupt trigger conditions detected (raw, prior to masking), indicating that all the requirements have been met, before they are finally allowed to trigger by the **GPIO Interrupt Mask (GPIOIM)** register (see page 137). Bits read as zero indicate that corresponding input pins have not initiated an interrupt. All bits are cleared by a reset.

GPIO Raw Interrupt Status (GPIORIS)

GPIO Port A base: 0x4000.4000
 GPIO Port B base: 0x4000.5000
 GPIO Port C base: 0x4000.6000
 GPIO Port D base: 0x4000.7000
 GPIO Port E base: 0x4002.4000
 Offset 0x414
 Type RO, reset 0x0000.0000

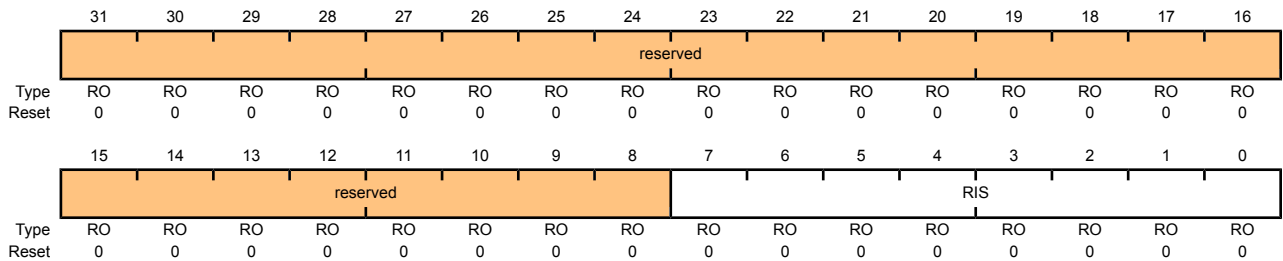

Bit/Field	Name	Type	Reset	Description
31:8	reserved	RO	0x00	Software should not rely on the value of a reserved bit. To provide compatibility with future products, the value of a reserved bit should be preserved across a read-modify-write operation.
7:0	RIS	RO	0x00	GPIO Interrupt Raw Status

Reflects the status of interrupt trigger condition detection on pins (raw, prior to masking).

The RIS values are defined as follows:

Value	Description
0	Corresponding pin interrupt requirements not met.
1	Corresponding pin interrupt has met requirements.

Register 8: GPIO Masked Interrupt Status (GPIOMIS), offset 0x418

The **GPIOMIS** register is the masked interrupt status register. Bits read High in **GPIOMIS** reflect the status of input lines triggering an interrupt. Bits read as Low indicate that either no interrupt has been generated, or the interrupt is masked.

In addition to providing GPIO functionality, **PB4** can also be used as an external trigger for the ADC. If **PB4** is configured as a non-masked interrupt pin (the appropriate bit of **GPIOIM** is set to 1), not only is an interrupt for PortB generated, but an external trigger signal is sent to the ADC. If the **ADC Event Multiplexer Select (ADCEMUX)** register is configured to use the external trigger, an ADC conversion is initiated.

If no other PortB pins are being used to generate interrupts, the ARM Integrated Nested Vectored Interrupt Controller (NVIC) Interrupt Set Enable (SETNA) register can disable the PortB interrupts and the ADC interrupt can be used to read back the converted data. Otherwise, the PortB interrupt handler needs to ignore and clear interrupts on **B4**, and wait for the ADC interrupt or the ADC interrupt needs to be disabled in the SETNA register and the PortB interrupt handler polls the ADC registers until the conversion is completed.

GPIOMIS is the state of the interrupt after masking.

GPIO Masked Interrupt Status (GPIOMIS)

GPIO Port A base: 0x4000.4000
 GPIO Port B base: 0x4000.5000
 GPIO Port C base: 0x4000.6000
 GPIO Port D base: 0x4000.7000
 GPIO Port E base: 0x4002.4000
 Offset 0x418
 Type RO, reset 0x0000.0000

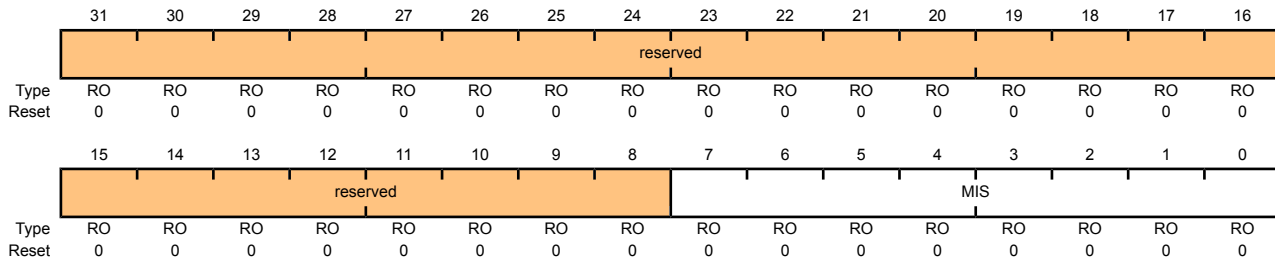

Bit/Field	Name	Type	Reset	Description
31:8	reserved	RO	0x00	Software should not rely on the value of a reserved bit. To provide compatibility with future products, the value of a reserved bit should be preserved across a read-modify-write operation.
7:0	MIS	RO	0x00	GPIO Masked Interrupt Status Masked value of interrupt due to corresponding pin. The MIS values are defined as follows: Value Description 0 Corresponding GPIO line interrupt not active. 1 Corresponding GPIO line asserting interrupt.

Register 9: GPIO Interrupt Clear (GPIOICR), offset 0x41C

The **GPIOICR** register is the interrupt clear register. Writing a 1 to a bit in this register clears the corresponding interrupt edge detection logic register. Writing a 0 has no effect.

GPIO Interrupt Clear (GPIOICR)

GPIO Port A base: 0x4000.4000
 GPIO Port B base: 0x4000.5000
 GPIO Port C base: 0x4000.6000
 GPIO Port D base: 0x4000.7000
 GPIO Port E base: 0x4002.4000
 Offset 0x41C
 Type W1C, reset 0x0000.0000

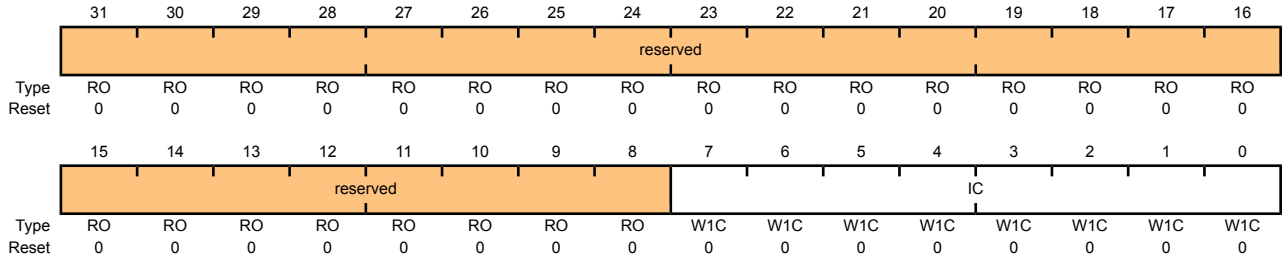

Bit/Field	Name	Type	Reset	Description
31:8	reserved	RO	0x00	Software should not rely on the value of a reserved bit. To provide compatibility with future products, the value of a reserved bit should be preserved across a read-modify-write operation.
7:0	IC	W1C	0x00	GPIO Interrupt Clear

The IC values are defined as follows:

Value	Description
0	Corresponding interrupt is unaffected.
1	Corresponding interrupt is cleared.

Register 10: GPIO Alternate Function Select (GPIOAFSEL), offset 0x420

The **GPIOAFSEL** register is the mode control select register. Writing a 1 to any bit in this register selects the hardware control for the corresponding GPIO line. All bits are cleared by a reset, therefore no GPIO line is set to hardware control by default.

Important: All GPIO pins are inputs by default (**GPDIR=0** and **GPIOAFSEL=0**), with the exception of the five JTAG pins (**PB7** and **PC[3:0]**). The JTAG pins default to their JTAG functionality (**GPIOAFSEL=1**). A Power-On-Reset (\overline{POR}) or asserting an external reset (\overline{RST}) puts both groups of pins back to their default state.

Caution – If the JTAG pins are used as GPIOs in a design, **PB7** and **PC2** cannot have external pull-down resistors connected to both of them at the same time. If both pins are pulled Low during reset, the controller has unpredictable behavior. If this happens, remove one or both of the pull-down resistors, and apply \overline{RST} or power-cycle the part.

It is possible to create a software sequence that prevents the debugger from connecting to the Stellaris® microcontroller. If the program code loaded into flash immediately changes the JTAG pins to their GPIO functionality, the debugger may not have enough time to connect and halt the controller before the JTAG pin functionality switches. This may lock the debugger out of the part. This can be avoided with a software routine that restores JTAG functionality based on an external or software trigger.

GPIO Alternate Function Select (GPIOAFSEL)

GPIO Port A base: 0x4000.4000
 GPIO Port B base: 0x4000.5000
 GPIO Port C base: 0x4000.6000
 GPIO Port D base: 0x4000.7000
 GPIO Port E base: 0x4002.4000
 Offset 0x420
 Type R/W, reset -

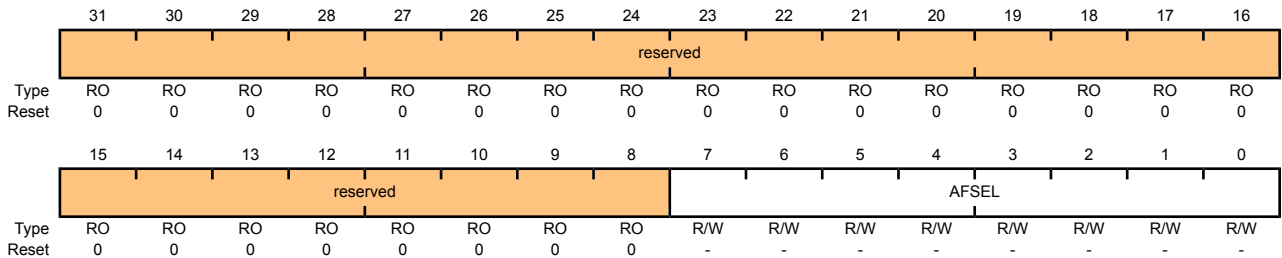

Bit/Field	Name	Type	Reset	Description
31:8	reserved	RO	0x00	Software should not rely on the value of a reserved bit. To provide compatibility with future products, the value of a reserved bit should be preserved across a read-modify-write operation.

Bit/Field	Name	Type	Reset	Description						
7:0	AFSEL	R/W	-	<p>GPIO Alternate Function Select</p> <p>The AFSEL values are defined as follows:</p> <table><thead><tr><th>Value</th><th>Description</th></tr></thead><tbody><tr><td>0</td><td>Software control of corresponding GPIO line (GPIO mode).</td></tr><tr><td>1</td><td>Hardware control of corresponding GPIO line (alternate hardware function).</td></tr></tbody></table> <p>Note: The default reset value for the GPIOAFSEL register is 0x0000.0000 for all GPIO pins, with the exception of the five JTAG pins (PB7 and PC[3:0]). These five pins default to JTAG functionality. Because of this, the default reset value of GPIOAFSEL for GPIO Port B is 0x0000.0080 while the default reset value for Port C is 0x0000.000F.</p>	Value	Description	0	Software control of corresponding GPIO line (GPIO mode).	1	Hardware control of corresponding GPIO line (alternate hardware function).
Value	Description									
0	Software control of corresponding GPIO line (GPIO mode).									
1	Hardware control of corresponding GPIO line (alternate hardware function).									

Register 11: GPIO 2-mA Drive Select (GPIODR2R), offset 0x500

The **GPIODR2R** register is the 2-mA drive control register. It allows for each GPIO signal in the port to be individually configured without affecting the other pads. When writing a **DRV2** bit for a GPIO signal, the corresponding **DRV4** bit in the **GPIODR4R** register and the **DRV8** bit in the **GPIODR8R** register are automatically cleared by hardware.

GPIO 2-mA Drive Select (GPIODR2R)

GPIO Port A base: 0x4000.4000
 GPIO Port B base: 0x4000.5000
 GPIO Port C base: 0x4000.6000
 GPIO Port D base: 0x4000.7000
 GPIO Port E base: 0x4002.4000
 Offset 0x500
 Type R/W, reset 0x0000.00FF

	31	30	29	28	27	26	25	24	23	22	21	20	19	18	17	16
	reserved															
Type	RO	RO	RO	RO	RO	RO	RO	RO	RO	RO	RO	RO	RO	RO	RO	RO
Reset	0	0	0	0	0	0	0	0	0	0	0	0	0	0	0	0
	15	14	13	12	11	10	9	8	7	6	5	4	3	2	1	0
	reserved								DRV2							
Type	RO	RO	RO	RO	RO	RO	RO	RO	R/W	R/W	R/W	R/W	R/W	R/W	R/W	R/W
Reset	0	0	0	0	0	0	0	0	1	1	1	1	1	1	1	1

Bit/Field	Name	Type	Reset	Description
31:8	reserved	RO	0x00	Software should not rely on the value of a reserved bit. To provide compatibility with future products, the value of a reserved bit should be preserved across a read-modify-write operation.
7:0	DRV2	R/W	0xFF	Output Pad 2-mA Drive Enable A write of 1 to either GPIODR4[n] or GPIODR8[n] clears the corresponding 2-mA enable bit. The change is effective on the second clock cycle after the write.

Register 12: GPIO 4-mA Drive Select (GPIODR4R), offset 0x504

The **GPIODR4R** register is the 4-mA drive control register. It allows for each GPIO signal in the port to be individually configured without affecting the other pads. When writing the **DRV4** bit for a GPIO signal, the corresponding **DRV2** bit in the **GPIODR2R** register and the **DRV8** bit in the **GPIODR8R** register are automatically cleared by hardware.

GPIO 4-mA Drive Select (GPIODR4R)

GPIO Port A base: 0x4000.4000
 GPIO Port B base: 0x4000.5000
 GPIO Port C base: 0x4000.6000
 GPIO Port D base: 0x4000.7000
 GPIO Port E base: 0x4002.4000
 Offset 0x504
 Type R/W, reset 0x0000.0000

	31	30	29	28	27	26	25	24	23	22	21	20	19	18	17	16
	reserved															
Type	RO	RO	RO	RO	RO	RO	RO	RO	RO	RO	RO	RO	RO	RO	RO	RO
Reset	0	0	0	0	0	0	0	0	0	0	0	0	0	0	0	0
	15	14	13	12	11	10	9	8	7	6	5	4	3	2	1	0
	reserved								DRV4							
Type	RO	RO	RO	RO	RO	RO	RO	RO	R/W	R/W	R/W	R/W	R/W	R/W	R/W	R/W
Reset	0	0	0	0	0	0	0	0	0	0	0	0	0	0	0	0

Bit/Field	Name	Type	Reset	Description
31:8	reserved	RO	0x00	Software should not rely on the value of a reserved bit. To provide compatibility with future products, the value of a reserved bit should be preserved across a read-modify-write operation.
7:0	DRV4	R/W	0x00	Output Pad 4-mA Drive Enable A write of 1 to either GPIODR2[n] or GPIODR8[n] clears the corresponding 4-mA enable bit. The change is effective on the second clock cycle after the write.

Register 13: GPIO 8-mA Drive Select (GPIODR8R), offset 0x508

The **GPIODR8R** register is the 8-mA drive control register. It allows for each GPIO signal in the port to be individually configured without affecting the other pads. When writing the **DRV8** bit for a GPIO signal, the corresponding **DRV2** bit in the **GPIODR2R** register and the **DRV4** bit in the **GPIODR4R** register are automatically cleared by hardware.

GPIO 8-mA Drive Select (GPIODR8R)

GPIO Port A base: 0x4000.4000
 GPIO Port B base: 0x4000.5000
 GPIO Port C base: 0x4000.6000
 GPIO Port D base: 0x4000.7000
 GPIO Port E base: 0x4002.4000
 Offset 0x508
 Type R/W, reset 0x0000.0000

	31	30	29	28	27	26	25	24	23	22	21	20	19	18	17	16
	reserved															
Type	RO	RO	RO	RO	RO	RO	RO	RO	RO	RO	RO	RO	RO	RO	RO	RO
Reset	0	0	0	0	0	0	0	0	0	0	0	0	0	0	0	0
	15	14	13	12	11	10	9	8	7	6	5	4	3	2	1	0
	reserved								DRV8							
Type	RO	RO	RO	RO	RO	RO	RO	RO	R/W	R/W	R/W	R/W	R/W	R/W	R/W	R/W
Reset	0	0	0	0	0	0	0	0	0	0	0	0	0	0	0	0

Bit/Field	Name	Type	Reset	Description
31:8	reserved	RO	0x00	Software should not rely on the value of a reserved bit. To provide compatibility with future products, the value of a reserved bit should be preserved across a read-modify-write operation.
7:0	DRV8	R/W	0x00	Output Pad 8-mA Drive Enable A write of 1 to either GPIODR2[n] or GPIODR4[n] clears the corresponding 8-mA enable bit. The change is effective on the second clock cycle after the write.

Register 14: GPIO Open Drain Select (GPIOODR), offset 0x50C

The **GPIOODR** register is the open drain control register. Setting a bit in this register enables the open drain configuration of the corresponding GPIO pad. When open drain mode is enabled, the corresponding bit should also be set in the **GPIO Digital Input Enable (GPIODEN)** register (see page 150). Corresponding bits in the drive strength registers (**GPIODR2R**, **GPIODR4R**, **GPIODR8R**, and **GPIOSLR**) can be set to achieve the desired rise and fall times. The GPIO acts as an open drain input if the corresponding bit in the **GPIODIR** register is set to 0; and as an open drain output when set to 1.

When using the I²C module, in addition to configuring the pin to open drain, the **GPIO Alternate Function Select (GPIOAFSEL)** register bit for the I²C clock and data pins should be set to 1 (see examples in “Initialization and Configuration” on page 128).

GPIO Open Drain Select (GPIOODR)

GPIO Port A base: 0x4000.4000
 GPIO Port B base: 0x4000.5000
 GPIO Port C base: 0x4000.6000
 GPIO Port D base: 0x4000.7000
 GPIO Port E base: 0x4002.4000
 Offset 0x50C
 Type R/W, reset 0x0000.0000

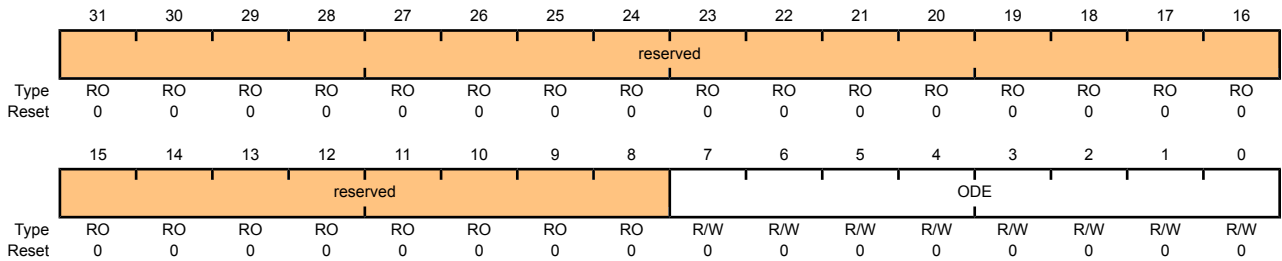

Bit/Field	Name	Type	Reset	Description
31:8	reserved	RO	0x00	Software should not rely on the value of a reserved bit. To provide compatibility with future products, the value of a reserved bit should be preserved across a read-modify-write operation.
7:0	ODE	R/W	0x00	Output Pad Open Drain Enable

The ODE values are defined as follows:

Value	Description
0	Open drain configuration is disabled.
1	Open drain configuration is enabled.

Register 15: GPIO Pull-Up Select (GPIOPUR), offset 0x510

The **GPIOPUR** register is the pull-up control register. When a bit is set to 1, it enables a weak pull-up resistor on the corresponding GPIO signal. Setting a bit in **GPIOPUR** automatically clears the corresponding bit in the **GPIO Pull-Down Select (GPIOPDR)** register (see page 148).

GPIO Pull-Up Select (GPIOPUR)

GPIO Port A base: 0x4000.4000

GPIO Port B base: 0x4000.5000

GPIO Port C base: 0x4000.6000

GPIO Port D base: 0x4000.7000

GPIO Port E base: 0x4002.4000

Offset 0x510

Type R/W, reset 0x0000.00FF

	31	30	29	28	27	26	25	24	23	22	21	20	19	18	17	16
	reserved															
Type	RO	RO	RO	RO	RO	RO	RO	RO	RO	RO	RO	RO	RO	RO	RO	RO
Reset	0	0	0	0	0	0	0	0	0	0	0	0	0	0	0	0
	15	14	13	12	11	10	9	8	7	6	5	4	3	2	1	0
	reserved								PUE							
Type	RO	RO	RO	RO	RO	RO	RO	RO	R/W	R/W	R/W	R/W	R/W	R/W	R/W	R/W
Reset	0	0	0	0	0	0	0	0	1	1	1	1	1	1	1	1

Bit/Field	Name	Type	Reset	Description
31:8	reserved	RO	0x00	Software should not rely on the value of a reserved bit. To provide compatibility with future products, the value of a reserved bit should be preserved across a read-modify-write operation.
7:0	PUE	R/W	0xFF	Pad Weak Pull-Up Enable A write of 1 to GPIOPDR[n] clears the corresponding GPIOPUR[n] enables. The change is effective on the second clock cycle after the write.

Register 16: GPIO Pull-Down Select (GPIOPDR), offset 0x514

The **GPIOPDR** register is the pull-down control register. When a bit is set to 1, it enables a weak pull-down resistor on the corresponding GPIO signal. Setting a bit in **GPIOPDR** automatically clears the corresponding bit in the **GPIO Pull-Up Select (GPIOPUR)** register (see page 147).

GPIO Pull-Down Select (GPIOPDR)

GPIO Port A base: 0x4000.4000
 GPIO Port B base: 0x4000.5000
 GPIO Port C base: 0x4000.6000
 GPIO Port D base: 0x4000.7000
 GPIO Port E base: 0x4002.4000
 Offset 0x514
 Type R/W, reset 0x0000.0000

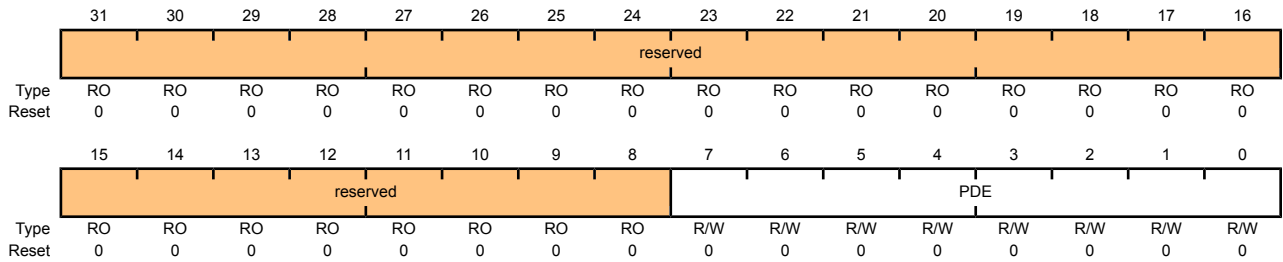

Bit/Field	Name	Type	Reset	Description
31:8	reserved	RO	0x00	Software should not rely on the value of a reserved bit. To provide compatibility with future products, the value of a reserved bit should be preserved across a read-modify-write operation.
7:0	PDE	R/W	0x00	Pad Weak Pull-Down Enable A write of 1 to GPIOPUR[n] clears the corresponding GPIOPDR[n] enables. The change is effective on the second clock cycle after the write.

Register 17: GPIO Slew Rate Control Select (GPIOSLR), offset 0x518

The **GPIOSLR** register is the slew rate control register. Slew rate control is only available when using the 8-mA drive strength option via the **GPIO 8-mA Drive Select (GPIO8R)** register (see page 145).

GPIO Slew Rate Control Select (GPIOSLR)

GPIO Port A base: 0x4000.4000
 GPIO Port B base: 0x4000.5000
 GPIO Port C base: 0x4000.6000
 GPIO Port D base: 0x4000.7000
 GPIO Port E base: 0x4002.4000
 Offset 0x518
 Type R/W, reset 0x0000.0000

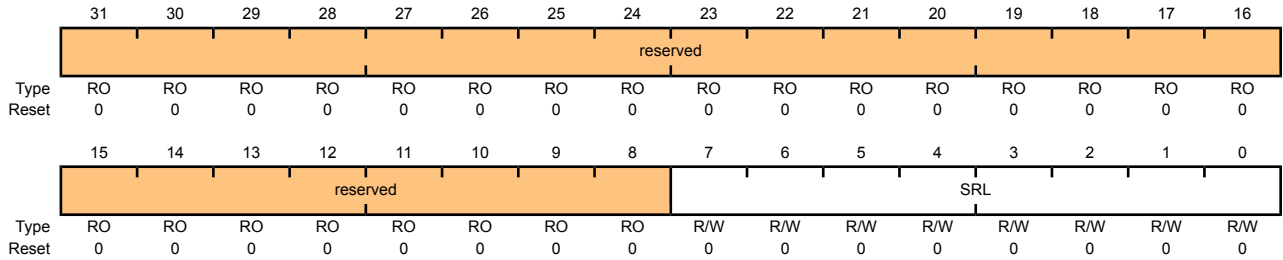

Bit/Field	Name	Type	Reset	Description
31:8	reserved	RO	0x00	Software should not rely on the value of a reserved bit. To provide compatibility with future products, the value of a reserved bit should be preserved across a read-modify-write operation.
7:0	SRL	R/W	0x00	Slew Rate Limit Enable (8-mA drive only)

The SRL values are defined as follows:

Value	Description
0	Slew rate control disabled.
1	Slew rate control enabled.

Register 18: GPIO Digital Enable (GPIODEN), offset 0x51C

Note: Pins configured as digital inputs are Schmitt-triggered.

The **GPIODEN** register is the digital input enable register. By default, all GPIO signals are configured as digital inputs at reset. If a pin is being used as a GPIO or its Alternate Hardware Function, it should be configured as a digital input.

GPIO Digital Enable (GPIODEN)

GPIO Port A base: 0x4000.4000
 GPIO Port B base: 0x4000.5000
 GPIO Port C base: 0x4000.6000
 GPIO Port D base: 0x4000.7000
 GPIO Port E base: 0x4002.4000
 Offset 0x51C
 Type R/W, reset 0x0000.00FF

	31	30	29	28	27	26	25	24	23	22	21	20	19	18	17	16
	reserved															
Type	RO	RO	RO	RO	RO	RO	RO	RO	RO	RO	RO	RO	RO	RO	RO	RO
Reset	0	0	0	0	0	0	0	0	0	0	0	0	0	0	0	0
	15	14	13	12	11	10	9	8	7	6	5	4	3	2	1	0
	reserved								DEN							
Type	RO	RO	RO	RO	RO	RO	RO	RO	R/W	R/W	R/W	R/W	R/W	R/W	R/W	R/W
Reset	0	0	0	0	0	0	0	0	1	1	1	1	1	1	1	1

Bit/Field	Name	Type	Reset	Description
31:8	reserved	RO	0x00	Software should not rely on the value of a reserved bit. To provide compatibility with future products, the value of a reserved bit should be preserved across a read-modify-write operation.
7:0	DEN	R/W	0xFF	Digital Enable

The DEN values are defined as follows:

Value	Description
0	Digital functions disabled.
1	Digital functions enabled.

Register 19: GPIO Peripheral Identification 4 (GPIOPeriphID4), offset 0xFD0

The **GPIOPeriphID4**, **GPIOPeriphID5**, **GPIOPeriphID6**, and **GPIOPeriphID7** registers can conceptually be treated as one 32-bit register; each register contains eight bits of the 32-bit register, used by software to identify the peripheral.

GPIO Peripheral Identification 4 (GPIOPeriphID4)

GPIO Port A base: 0x4000.4000

GPIO Port B base: 0x4000.5000

GPIO Port C base: 0x4000.6000

GPIO Port D base: 0x4000.7000

GPIO Port E base: 0x4002.4000

Offset 0xFD0

Type RO, reset 0x0000.0000

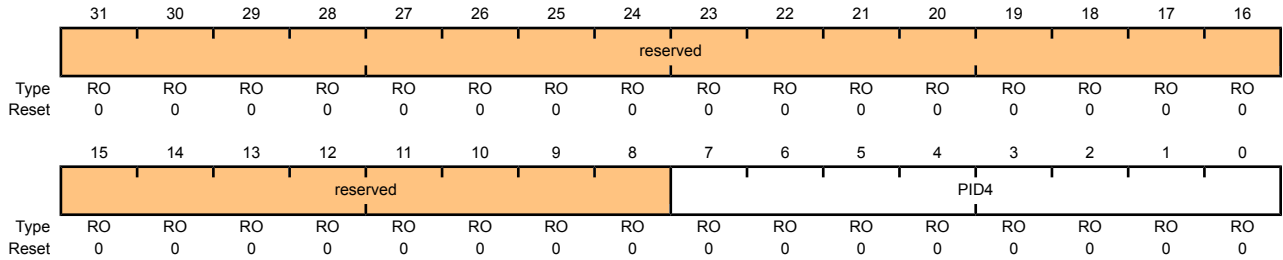

Bit/Field	Name	Type	Reset	Description
31:8	reserved	RO	0x00	Software should not rely on the value of a reserved bit. To provide compatibility with future products, the value of a reserved bit should be preserved across a read-modify-write operation.
7:0	PID4	RO	0x00	GPIO Peripheral ID Register[7:0]

Register 20: GPIO Peripheral Identification 5 (GPIOPeriphID5), offset 0xFD4

The **GPIOPeriphID4**, **GPIOPeriphID5**, **GPIOPeriphID6**, and **GPIOPeriphID7** registers can conceptually be treated as one 32-bit register; each register contains eight bits of the 32-bit register, used by software to identify the peripheral.

GPIO Peripheral Identification 5 (GPIOPeriphID5)

GPIO Port A base: 0x4000.4000
 GPIO Port B base: 0x4000.5000
 GPIO Port C base: 0x4000.6000
 GPIO Port D base: 0x4000.7000
 GPIO Port E base: 0x4002.4000
 Offset 0xFD4
 Type RO, reset 0x0000.0000

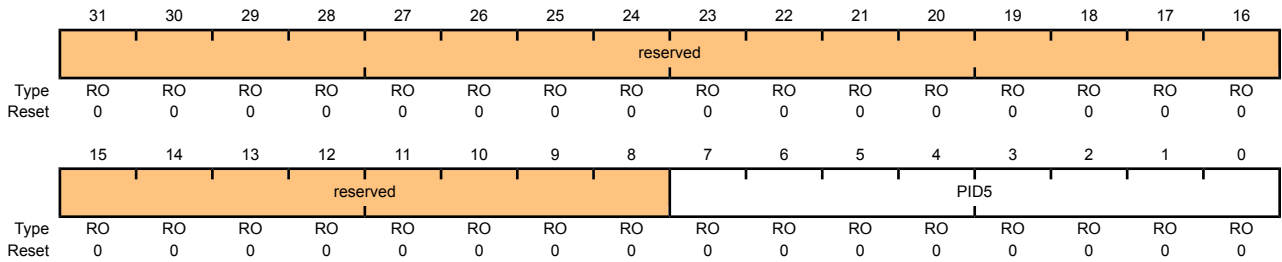

Bit/Field	Name	Type	Reset	Description
31:8	reserved	RO	0x00	Software should not rely on the value of a reserved bit. To provide compatibility with future products, the value of a reserved bit should be preserved across a read-modify-write operation.
7:0	PID5	RO	0x00	GPIO Peripheral ID Register[15:8]

Register 21: GPIO Peripheral Identification 6 (GPIOPeriphID6), offset 0xFD8

The **GPIOPeriphID4**, **GPIOPeriphID5**, **GPIOPeriphID6**, and **GPIOPeriphID7** registers can conceptually be treated as one 32-bit register; each register contains eight bits of the 32-bit register, used by software to identify the peripheral.

GPIO Peripheral Identification 6 (GPIOPeriphID6)

GPIO Port A base: 0x4000.4000

GPIO Port B base: 0x4000.5000

GPIO Port C base: 0x4000.6000

GPIO Port D base: 0x4000.7000

GPIO Port E base: 0x4002.4000

Offset 0xFD8

Type RO, reset 0x0000.0000

	31	30	29	28	27	26	25	24	23	22	21	20	19	18	17	16
	reserved															
Type	RO	RO	RO	RO	RO	RO	RO	RO	RO	RO	RO	RO	RO	RO	RO	RO
Reset	0	0	0	0	0	0	0	0	0	0	0	0	0	0	0	0
	15	14	13	12	11	10	9	8	7	6	5	4	3	2	1	0
	reserved								PID6							
Type	RO	RO	RO	RO	RO	RO	RO	RO	RO	RO	RO	RO	RO	RO	RO	RO
Reset	0	0	0	0	0	0	0	0	0	0	0	0	0	0	0	0

Bit/Field	Name	Type	Reset	Description
31:8	reserved	RO	0x00	Software should not rely on the value of a reserved bit. To provide compatibility with future products, the value of a reserved bit should be preserved across a read-modify-write operation.
7:0	PID6	RO	0x00	GPIO Peripheral ID Register[23:16]

Register 22: GPIO Peripheral Identification 7 (GPIOPeriphID7), offset 0xFDC

The **GPIOPeriphID4**, **GPIOPeriphID5**, **GPIOPeriphID6**, and **GPIOPeriphID7** registers can conceptually be treated as one 32-bit register; each register contains eight bits of the 32-bit register, used by software to identify the peripheral.

GPIO Peripheral Identification 7 (GPIOPeriphID7)

GPIO Port A base: 0x4000.4000
 GPIO Port B base: 0x4000.5000
 GPIO Port C base: 0x4000.6000
 GPIO Port D base: 0x4000.7000
 GPIO Port E base: 0x4002.4000
 Offset 0xFDC
 Type RO, reset 0x0000.0000

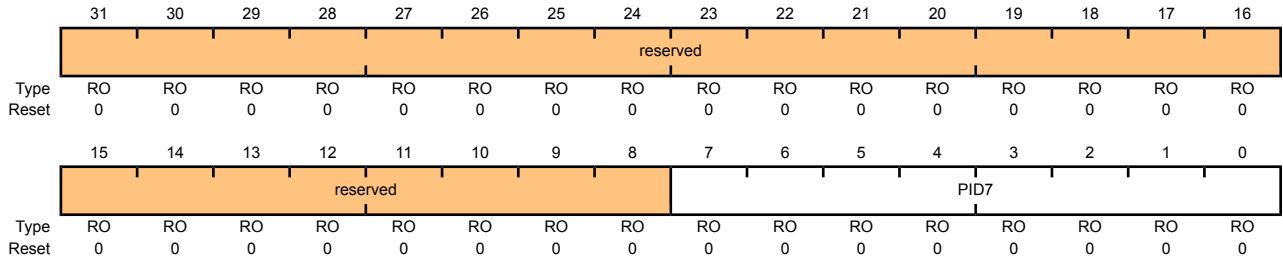

Bit/Field	Name	Type	Reset	Description
31:8	reserved	RO	0x00	Software should not rely on the value of a reserved bit. To provide compatibility with future products, the value of a reserved bit should be preserved across a read-modify-write operation.
7:0	PID7	RO	0x00	GPIO Peripheral ID Register[31:24]

Register 23: GPIO Peripheral Identification 0 (GPIOPeriphID0), offset 0xFE0

The **GPIOPeriphID0**, **GPIOPeriphID1**, **GPIOPeriphID2**, and **GPIOPeriphID3** registers can conceptually be treated as one 32-bit register; each register contains eight bits of the 32-bit register, used by software to identify the peripheral.

GPIO Peripheral Identification 0 (GPIOPeriphID0)

GPIO Port A base: 0x4000.4000

GPIO Port B base: 0x4000.5000

GPIO Port C base: 0x4000.6000

GPIO Port D base: 0x4000.7000

GPIO Port E base: 0x4002.4000

Offset 0xFE0

Type RO, reset 0x0000.0061

	31	30	29	28	27	26	25	24	23	22	21	20	19	18	17	16
	reserved															
Type	RO	RO	RO	RO	RO	RO	RO	RO	RO	RO	RO	RO	RO	RO	RO	RO
Reset	0	0	0	0	0	0	0	0	0	0	0	0	0	0	0	0
	15	14	13	12	11	10	9	8	7	6	5	4	3	2	1	0
	reserved								PID0							
Type	RO	RO	RO	RO	RO	RO	RO	RO	RO	RO	RO	RO	RO	RO	RO	RO
Reset	0	0	0	0	0	0	0	0	0	1	1	0	0	0	0	1

Bit/Field	Name	Type	Reset	Description
31:8	reserved	RO	0x00	Software should not rely on the value of a reserved bit. To provide compatibility with future products, the value of a reserved bit should be preserved across a read-modify-write operation.
7:0	PID0	RO	0x61	GPIO Peripheral ID Register[7:0] Can be used by software to identify the presence of this peripheral.

Register 24: GPIO Peripheral Identification 1 (GPIOPeriphID1), offset 0xFE4

The **GPIOPeriphID0**, **GPIOPeriphID1**, **GPIOPeriphID2**, and **GPIOPeriphID3** registers can conceptually be treated as one 32-bit register; each register contains eight bits of the 32-bit register, used by software to identify the peripheral.

GPIO Peripheral Identification 1 (GPIOPeriphID1)

GPIO Port A base: 0x4000.4000
 GPIO Port B base: 0x4000.5000
 GPIO Port C base: 0x4000.6000
 GPIO Port D base: 0x4000.7000
 GPIO Port E base: 0x4002.4000
 Offset 0xFE4
 Type RO, reset 0x0000.0000

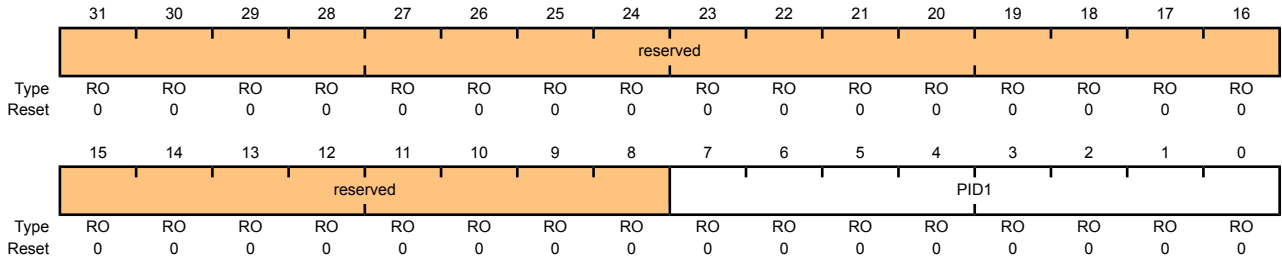

Bit/Field	Name	Type	Reset	Description
31:8	reserved	RO	0x00	Software should not rely on the value of a reserved bit. To provide compatibility with future products, the value of a reserved bit should be preserved across a read-modify-write operation.
7:0	PID1	RO	0x00	GPIO Peripheral ID Register[15:8] Can be used by software to identify the presence of this peripheral.

Register 25: GPIO Peripheral Identification 2 (GPIOPeriphID2), offset 0xFE8

The **GPIOPeriphID0**, **GPIOPeriphID1**, **GPIOPeriphID2**, and **GPIOPeriphID3** registers can conceptually be treated as one 32-bit register; each register contains eight bits of the 32-bit register, used by software to identify the peripheral.

GPIO Peripheral Identification 2 (GPIOPeriphID2)

GPIO Port A base: 0x4000.4000

GPIO Port B base: 0x4000.5000

GPIO Port C base: 0x4000.6000

GPIO Port D base: 0x4000.7000

GPIO Port E base: 0x4002.4000

Offset 0xFE8

Type RO, reset 0x0000.0018

	31	30	29	28	27	26	25	24	23	22	21	20	19	18	17	16
	reserved															
Type	RO	RO	RO	RO	RO	RO	RO	RO	RO	RO	RO	RO	RO	RO	RO	RO
Reset	0	0	0	0	0	0	0	0	0	0	0	0	0	0	0	0
	15	14	13	12	11	10	9	8	7	6	5	4	3	2	1	0
	reserved								PID2							
Type	RO	RO	RO	RO	RO	RO	RO	RO	RO	RO	RO	RO	RO	RO	RO	RO
Reset	0	0	0	0	0	0	0	0	0	0	0	1	1	0	0	0

Bit/Field	Name	Type	Reset	Description
31:8	reserved	RO	0x00	Software should not rely on the value of a reserved bit. To provide compatibility with future products, the value of a reserved bit should be preserved across a read-modify-write operation.
7:0	PID2	RO	0x18	GPIO Peripheral ID Register[23:16] Can be used by software to identify the presence of this peripheral.

Register 26: GPIO Peripheral Identification 3 (GPIOPeriphID3), offset 0xFEC

The **GPIOPeriphID0**, **GPIOPeriphID1**, **GPIOPeriphID2**, and **GPIOPeriphID3** registers can conceptually be treated as one 32-bit register; each register contains eight bits of the 32-bit register, used by software to identify the peripheral.

GPIO Peripheral Identification 3 (GPIOPeriphID3)

GPIO Port A base: 0x4000.4000
 GPIO Port B base: 0x4000.5000
 GPIO Port C base: 0x4000.6000
 GPIO Port D base: 0x4000.7000
 GPIO Port E base: 0x4002.4000
 Offset 0xFEC
 Type RO, reset 0x0000.0001

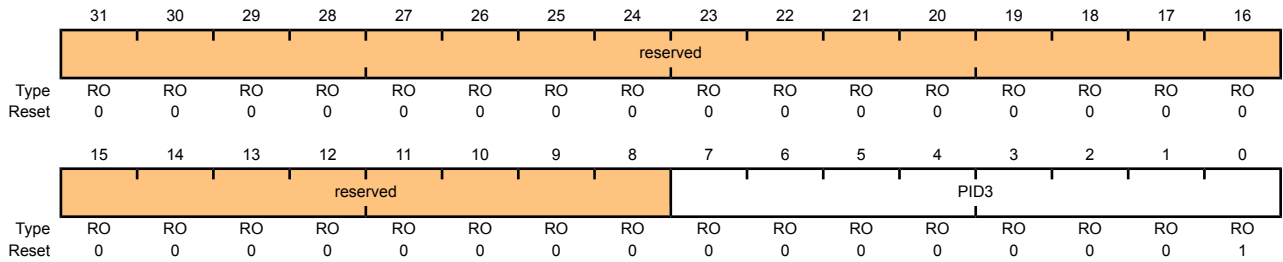

Bit/Field	Name	Type	Reset	Description
31:8	reserved	RO	0x00	Software should not rely on the value of a reserved bit. To provide compatibility with future products, the value of a reserved bit should be preserved across a read-modify-write operation.
7:0	PID3	RO	0x01	GPIO Peripheral ID Register[31:24] Can be used by software to identify the presence of this peripheral.

Register 27: GPIO PrimeCell Identification 0 (GPIOCellID0), offset 0xFF0

The **GPIOCellID0**, **GPIOCellID1**, **GPIOCellID2**, and **GPIOCellID3** registers are four 8-bit wide registers, that can conceptually be treated as one 32-bit register. The register is used as a standard cross-peripheral identification system.

GPIO PrimeCell Identification 0 (GPIOCellID0)

GPIO Port A base: 0x4000.4000

GPIO Port B base: 0x4000.5000

GPIO Port C base: 0x4000.6000

GPIO Port D base: 0x4000.7000

GPIO Port E base: 0x4002.4000

Offset 0xFF0

Type RO, reset 0x0000.000D

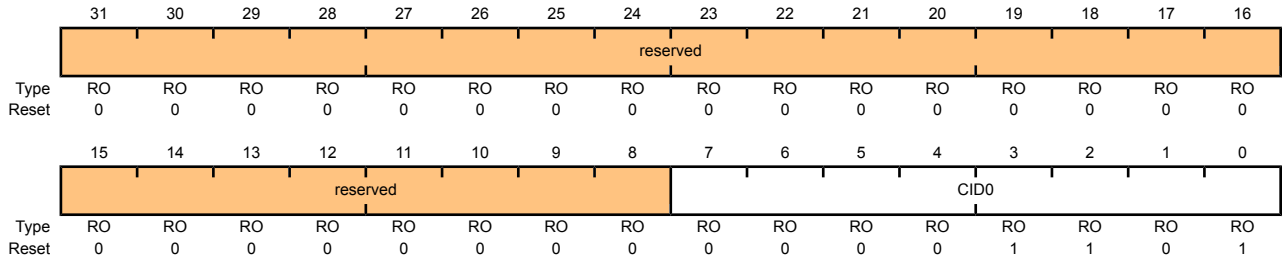

Bit/Field	Name	Type	Reset	Description
31:8	reserved	RO	0x00	Software should not rely on the value of a reserved bit. To provide compatibility with future products, the value of a reserved bit should be preserved across a read-modify-write operation.
7:0	CID0	RO	0x0D	GPIO PrimeCell ID Register[7:0] Provides software a standard cross-peripheral identification system.

Register 28: GPIO PrimeCell Identification 1 (GPIOCellID1), offset 0xFF4

The **GPIOCellID0**, **GPIOCellID1**, **GPIOCellID2**, and **GPIOCellID3** registers are four 8-bit wide registers, that can conceptually be treated as one 32-bit register. The register is used as a standard cross-peripheral identification system.

GPIO PrimeCell Identification 1 (GPIOCellID1)

GPIO Port A base: 0x4000.4000
 GPIO Port B base: 0x4000.5000
 GPIO Port C base: 0x4000.6000
 GPIO Port D base: 0x4000.7000
 GPIO Port E base: 0x4002.4000
 Offset 0xFF4
 Type RO, reset 0x0000.00F0

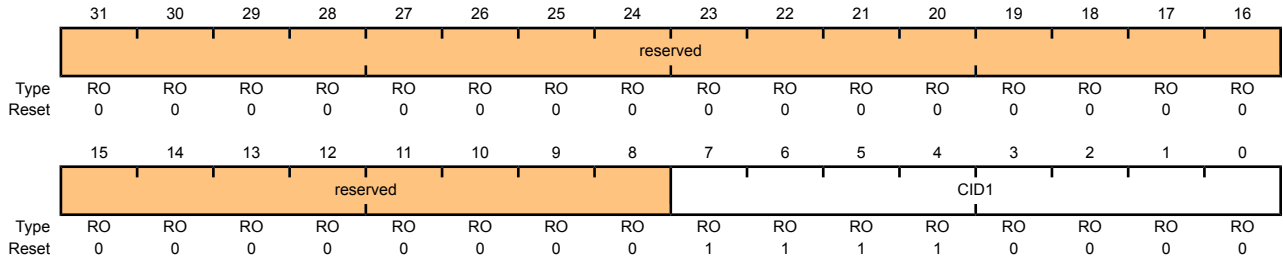

Bit/Field	Name	Type	Reset	Description
31:8	reserved	RO	0x00	Software should not rely on the value of a reserved bit. To provide compatibility with future products, the value of a reserved bit should be preserved across a read-modify-write operation.
7:0	CID1	RO	0xF0	GPIO PrimeCell ID Register[15:8] Provides software a standard cross-peripheral identification system.

Register 29: GPIO PrimeCell Identification 2 (GPIOCellID2), offset 0xFF8

The **GPIOCellID0**, **GPIOCellID1**, **GPIOCellID2**, and **GPIOCellID3** registers are four 8-bit wide registers, that can conceptually be treated as one 32-bit register. The register is used as a standard cross-peripheral identification system.

GPIO PrimeCell Identification 2 (GPIOCellID2)

GPIO Port A base: 0x4000.4000
 GPIO Port B base: 0x4000.5000
 GPIO Port C base: 0x4000.6000
 GPIO Port D base: 0x4000.7000
 GPIO Port E base: 0x4002.4000
 Offset 0xFF8
 Type RO, reset 0x0000.0005

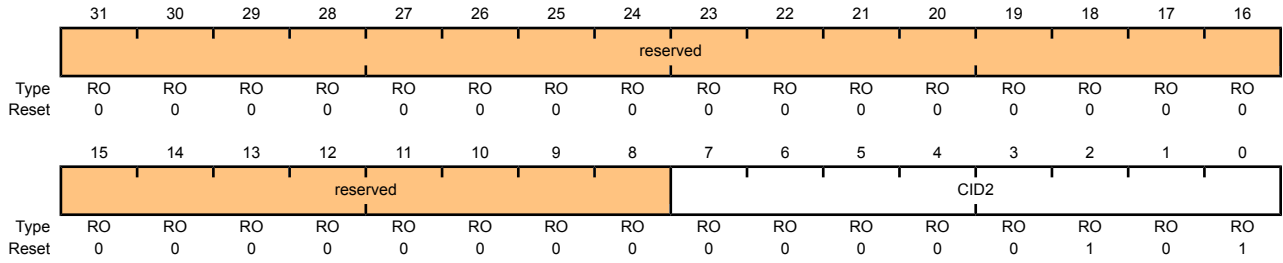

Bit/Field	Name	Type	Reset	Description
31:8	reserved	RO	0x00	Software should not rely on the value of a reserved bit. To provide compatibility with future products, the value of a reserved bit should be preserved across a read-modify-write operation.
7:0	CID2	RO	0x05	GPIO PrimeCell ID Register[23:16] Provides software a standard cross-peripheral identification system.

Register 30: GPIO PrimeCell Identification 3 (GPIOCellID3), offset 0xFFC

The **GPIOCellID0**, **GPIOCellID1**, **GPIOCellID2**, and **GPIOCellID3** registers are four 8-bit wide registers, that can conceptually be treated as one 32-bit register. The register is used as a standard cross-peripheral identification system.

GPIO PrimeCell Identification 3 (GPIOCellID3)

GPIO Port A base: 0x4000.4000
 GPIO Port B base: 0x4000.5000
 GPIO Port C base: 0x4000.6000
 GPIO Port D base: 0x4000.7000
 GPIO Port E base: 0x4002.4000
 Offset 0xFFC
 Type RO, reset 0x0000.00B1

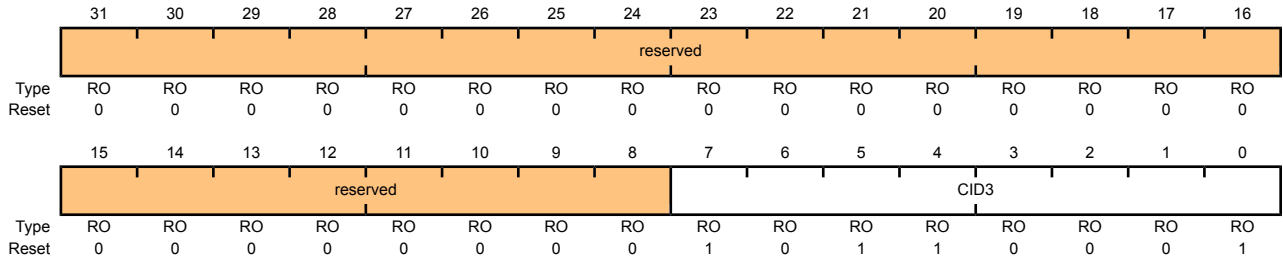

Bit/Field	Name	Type	Reset	Description
31:8	reserved	RO	0x00	Software should not rely on the value of a reserved bit. To provide compatibility with future products, the value of a reserved bit should be preserved across a read-modify-write operation.
7:0	CID3	RO	0xB1	GPIO PrimeCell ID Register[31:24] Provides software a standard cross-peripheral identification system.

9 General-Purpose Timers

Programmable timers can be used to count or time external events that drive the Timer input pins. The Stellaris[®] General-Purpose Timer Module (GPTM) contains three GPTM blocks (Timer0, Timer1, and Timer 2). Each GPTM block provides two 16-bit timers/counters (referred to as TimerA and TimerB) that can be configured to operate independently as timers or event counters, or configured to operate as one 32-bit timer or one 32-bit Real-Time Clock (RTC). Timers can also be used to trigger analog-to-digital (ADC) conversions. The trigger signals from all of the general-purpose timers are ORed together before reaching the ADC module, so only one timer should be used to trigger ADC events.

The General-Purpose Timer Module is one timing resource available on the Stellaris[®] microcontrollers. Other timer resources include the System Timer (SysTick) (see “System Timer (SysTick)” on page 34).

The following modes are supported:

- 32-bit Timer modes
 - Programmable one-shot timer
 - Programmable periodic timer
 - Real-Time Clock using 32.768-KHz input clock
 - Software-controlled event stalling (excluding RTC mode)
- 16-bit Timer modes
 - General-purpose timer function with an 8-bit prescaler (for one-shot and periodic modes only)
 - Programmable one-shot timer
 - Programmable periodic timer
 - Software-controlled event stalling
- 16-bit Input Capture modes
 - Input edge count capture
 - Input edge time capture
- 16-bit PWM mode
 - Simple PWM mode with software-programmable output inversion of the PWM signal

9.1 Block Diagram

Note: In Figure 9-1 on page 164, the specific CCP pins available depend on the Stellaris[®] device. See Table 9-1 on page 164 for the available CCPs.

Figure 9-1. GPTM Module Block Diagram

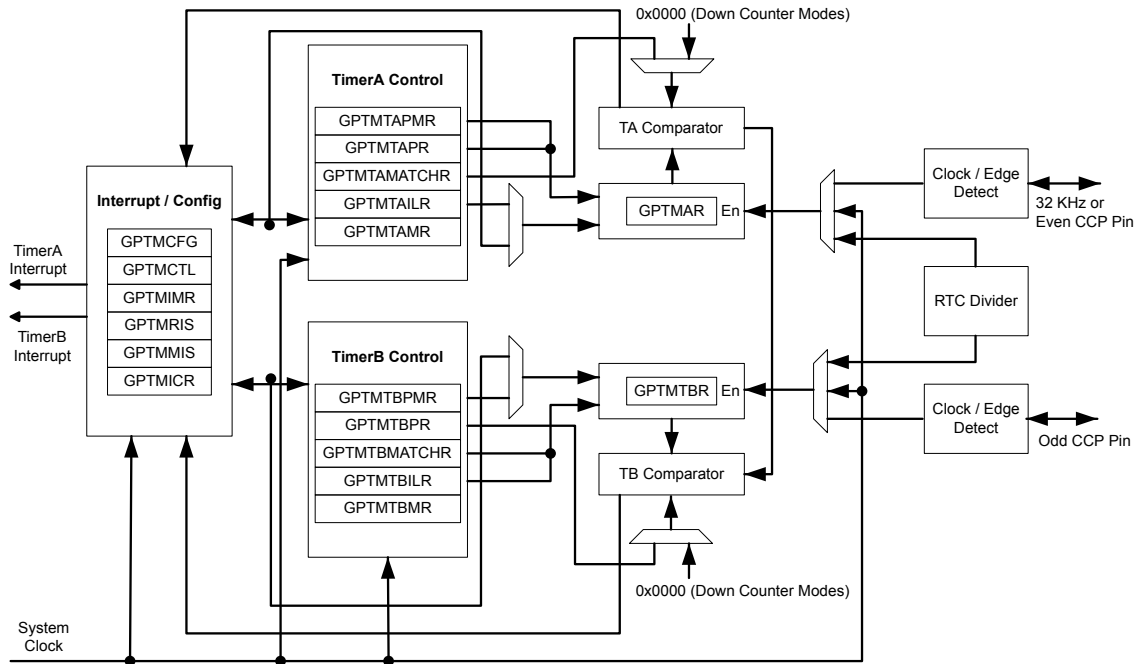

Table 9-1. Available CCP Pins

Timer	16-Bit Up/Down Counter	Even CCP Pin	Odd CCP Pin
Timer 0	TimerA	CCP0	-
	TimerB	-	CCP1
Timer 1	TimerA	CCP2	-
	TimerB	-	CCP3
Timer 2	TimerA	CCP4	-
	TimerB	-	CCP5

9.2 Functional Description

The main components of each GPTM block are two free-running 16-bit up/down counters (referred to as TimerA and TimerB), two 16-bit match registers, two prescaler match registers, and two 16-bit load/initialization registers and their associated control functions. The exact functionality of each GPTM is controlled by software and configured through the register interface.

Software configures the GPTM using the **GPTM Configuration (GPTMCFG)** register (see page 175), the **GPTM TimerA Mode (GPTMTAMR)** register (see page 176), and the **GPTM TimerB Mode (GPTMTBMR)** register (see page 178). When in one of the 32-bit modes, the timer can only act as a 32-bit timer. However, when configured in 16-bit mode, the GPTM can have its two 16-bit timers configured in any combination of the 16-bit modes.

9.2.1 GPTM Reset Conditions

After reset has been applied to the GPTM module, the module is in an inactive state, and all control registers are cleared and in their default states. Counters TimerA and TimerB are initialized to 0xFFFF, along with their corresponding load registers: the **GPTM TimerA Interval Load**

(**GPTMTAILR**) register (see page 189) and the **GPTM TimerB Interval Load (GPTMTBILR)** register (see page 190). The prescale counters are initialized to 0x00: the **GPTM TimerA Prescale (GPTMTAPR)** register (see page 193) and the **GPTM TimerB Prescale (GPTMTBPR)** register (see page 194).

9.2.2 32-Bit Timer Operating Modes

This section describes the three GPTM 32-bit timer modes (One-Shot, Periodic, and RTC) and their configuration.

The GPTM is placed into 32-bit mode by writing a 0 (One-Shot/Periodic 32-bit timer mode) or a 1 (RTC mode) to the **GPTM Configuration (GPTMCFG)** register. In both configurations, certain GPTM registers are concatenated to form pseudo 32-bit registers. These registers include:

- **GPTM TimerA Interval Load (GPTMTAILR)** register [15:0], see page 189
- **GPTM TimerB Interval Load (GPTMTBILR)** register [15:0], see page 190
- **GPTM TimerA (GPTMTAR)** register [15:0], see page 197
- **GPTM TimerB (GPTMTBR)** register [15:0], see page 198

In the 32-bit modes, the GPTM translates a 32-bit write access to **GPTMTAILR** into a write access to both **GPTMTAILR** and **GPTMTBILR**. The resulting word ordering for such a write operation is:

```
GPTMTBILR[15:0]:GPTMTAILR[15:0]
```

Likewise, a read access to **GPTMTAR** returns the value:

```
GPTMTBR[15:0]:GPTMTAR[15:0]
```

9.2.2.1 32-Bit One-Shot/Periodic Timer Mode

In 32-bit one-shot and periodic timer modes, the concatenated versions of the TimerA and TimerB registers are configured as a 32-bit down-counter. The selection of one-shot or periodic mode is determined by the value written to the **TAMR** field of the **GPTM TimerA Mode (GPTMTAMR)** register (see page 176), and there is no need to write to the **GPTM TimerB Mode (GPTMTBMR)** register.

When software writes the **TAEN** bit in the **GPTM Control (GPTMCTL)** register (see page 180), the timer begins counting down from its preloaded value. Once the 0x0000.0000 state is reached, the timer reloads its start value from the concatenated **GPTMTAILR** on the next cycle. If configured to be a one-shot timer, the timer stops counting and clears the **TAEN** bit in the **GPTMCTL** register. If configured as a periodic timer, it continues counting.

In addition to reloading the count value, the GPTM generates interrupts and triggers when it reaches the 0x000.0000 state. The GPTM sets the **TATORIS** bit in the **GPTM Raw Interrupt Status (GPTMRIS)** register (see page 185), and holds it until it is cleared by writing the **GPTM Interrupt Clear (GPTMICR)** register (see page 187). If the time-out interrupt is enabled in the **GPTM Interrupt Mask (GPTIMR)** register (see page 183), the GPTM also sets the **TATOMIS** bit in the **GPTM Masked Interrupt Status (GPTMMIS)** register (see page 186). The trigger is enabled by setting the **TAOTE** bit in **GPTMCTL**, and can trigger SoC-level events such as ADC conversions.

If software reloads the **GPTMTAILR** register while the counter is running, the counter loads the new value on the next clock cycle and continues counting from the new value.

If the **TASTALL** bit in the **GPTMCTL** register is asserted, the timer freezes counting until the signal is deasserted.

9.2.2.2 32-Bit Real-Time Clock Timer Mode

In Real-Time Clock (RTC) mode, the concatenated versions of the TimerA and TimerB registers are configured as a 32-bit up-counter. When RTC mode is selected for the first time, the counter is loaded with a value of 0x0000.0001. All subsequent load values must be written to the **GPTM TimerA Match (GPTMTAMATCHR)** register (see page 191) by the controller.

The input clock on the CCP0, CCP2, or CCP4 pins is required to be 32.768 KHz in RTC mode. The clock signal is then divided down to a 1 Hz rate and is passed along to the input of the 32-bit counter.

When software writes the TAEN bit in the **GPTMCTL** register, the counter starts counting up from its preloaded value of 0x0000.0001. When the current count value matches the preloaded value in the **GPTMTAMATCHR** register, it rolls over to a value of 0x0000.0000 and continues counting until either a hardware reset, or it is disabled by software (clearing the TAEN bit). When a match occurs, the GPTM asserts the RTCRIS bit in **GPTMRIS**. If the RTC interrupt is enabled in **GPTIMR**, the GPTM also sets the RTCMIS bit in **GPTMISR** and generates a controller interrupt. The status flags are cleared by writing the RTCCINT bit in **GPTMICR**.

If the TASTALL and/or TBSTALL bits in the **GPTMCTL** register are set, the timer does not freeze if the RTCEN bit is set in **GPTMCTL**.

9.2.3 16-Bit Timer Operating Modes

The GPTM is placed into global 16-bit mode by writing a value of 0x4 to the **GPTM Configuration (GPTMCFG)** register (see page 175). This section describes each of the GPTM 16-bit modes of operation. TimerA and TimerB have identical modes, so a single description is given using an *n* to reference both.

9.2.3.1 16-Bit One-Shot/Periodic Timer Mode

In 16-bit one-shot and periodic timer modes, the timer is configured as a 16-bit down-counter with an optional 8-bit prescaler that effectively extends the counting range of the timer to 24 bits. The selection of one-shot or periodic mode is determined by the value written to the TnMR field of the **GPTMTnMR** register. The optional prescaler is loaded into the **GPTM Timern Prescale (GPTMTnPR)** register.

When software writes the TnEN bit in the **GPTMCTL** register, the timer begins counting down from its preloaded value. Once the 0x0000 state is reached, the timer reloads its start value from **GPTMTnILR** and **GPTMTnPR** on the next cycle. If configured to be a one-shot timer, the timer stops counting and clears the TnEN bit in the **GPTMCTL** register. If configured as a periodic timer, it continues counting.

In addition to reloading the count value, the timer generates interrupts and triggers when it reaches the 0x0000 state. The GPTM sets the TnTORIS bit in the **GPTMRIS** register, and holds it until it is cleared by writing the **GPTMICR** register. If the time-out interrupt is enabled in **GPTIMR**, the GPTM also sets the TnTOMIS bit in **GPTMISR** and generates a controller interrupt. The trigger is enabled by setting the TnOTE bit in the **GPTMCTL** register, and can trigger SoC-level events such as ADC conversions.

If software reloads the **GPTMTAILR** register while the counter is running, the counter loads the new value on the next clock cycle and continues counting from the new value.

If the TnSTALL bit in the **GPTMCTL** register is enabled, the timer freezes counting until the signal is deasserted.

The following example shows a variety of configurations for a 16-bit free running timer while using the prescaler. All values assume a 50-MHz clock with Tc=20 ns (clock period).

Table 9-2. 16-Bit Timer With Prescaler Configurations

Prescale	#Clock (T _c) ^a	Max Time	Units
00000000	1	1.3107	mS
00000001	2	2.6214	mS
00000010	3	3.9321	mS
-----	--	--	--
11111100	254	332.9229	mS
11111110	255	334.2336	mS
11111111	256	335.5443	mS

a. T_c is the clock period.

9.2.3.2 16-Bit Input Edge Count Mode

Note: For rising-edge detection, the input signal must be High for at least two system clock periods following the rising edge. Similarly, for falling-edge detection, the input signal must be Low for at least two system clock periods following the falling edge. Based on this criteria, the maximum input frequency for edge detection is 1/4 of the system frequency.

Note: The prescaler is not available in 16-Bit Input Edge Count mode.

In Edge Count mode, the timer is configured as a down-counter capable of capturing three types of events: rising edge, falling edge, or both. To place the timer in Edge Count mode, the T_nCMR bit of the **GPTMTnMR** register must be set to 0. The type of edge that the timer counts is determined by the T_nEVENT fields of the **GPTMCTL** register. During initialization, the **GPTM Timern Match (GPTMTnMATCHR)** register is configured so that the difference between the value in the **GPTMTnILR** register and the **GPTMTnMATCHR** register equals the number of edge events that must be counted.

When software writes the T_nEN bit in the **GPTM Control (GPTMCTL)** register, the timer is enabled for event capture. Each input event on the CCP pin decrements the counter by 1 until the event count matches **GPTMTnMATCHR**. When the counts match, the GPTM asserts the C_nMRIS bit in the **GPTMRIS** register (and the C_nMMIS bit, if the interrupt is not masked). The counter is then reloaded using the value in **GPTMTnILR**, and stopped since the GPTM automatically clears the T_nEN bit in the **GPTMCTL** register. Once the event count has been reached, all further events are ignored until T_nEN is re-enabled by software.

Figure 9-2 on page 168 shows how input edge count mode works. In this case, the timer start value is set to **GPTMnILR** = 0x000A and the match value is set to **GPTMnMATCHR** = 0x0006 so that four edge events are counted. The counter is configured to detect both edges of the input signal.

Note that the last two edges are not counted since the timer automatically clears the T_nEN bit after the current count matches the value in the **GPTMnMR** register.

Figure 9-2. 16-Bit Input Edge Count Mode Example

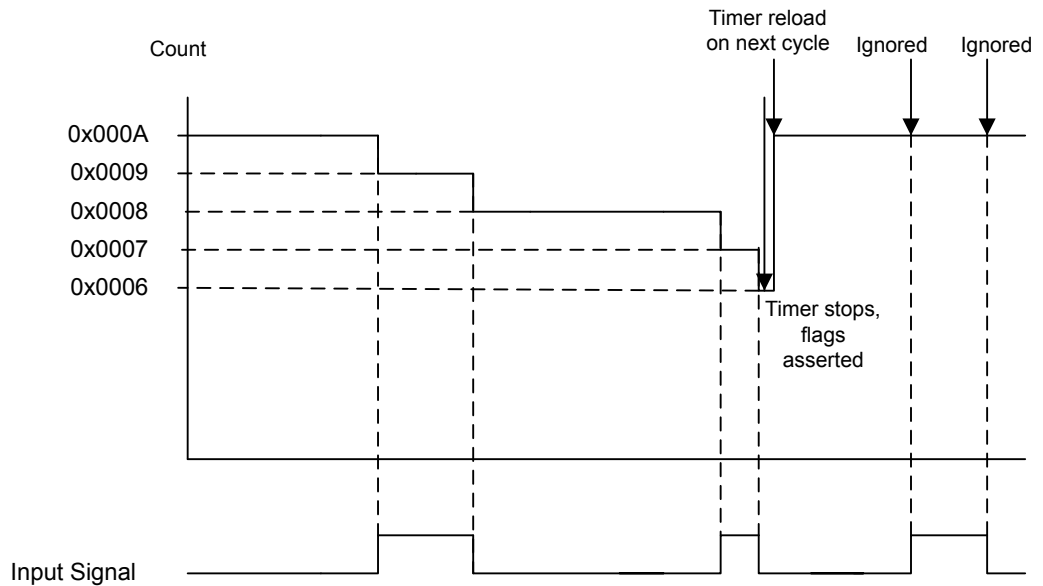

9.2.3.3 16-Bit Input Edge Time Mode

Note: For rising-edge detection, the input signal must be High for at least two system clock periods following the rising edge. Similarly, for falling edge detection, the input signal must be Low for at least two system clock periods following the falling edge. Based on this criteria, the maximum input frequency for edge detection is 1/4 of the system frequency.

Note: The prescaler is not available in 16-Bit Input Edge Time mode.

In Edge Time mode, the timer is configured as a free-running down-counter initialized to the value loaded in the **GPTMTnILR** register (or 0xFFFF at reset). This mode allows for event capture of either rising or falling edges, but not both. The timer is placed into Edge Time mode by setting the **TnCMR** bit in the **GPTMTnMR** register, and the type of event that the timer captures is determined by the **TnEVENT** fields of the **GPTMCnTL** register.

When software writes the **TnEN** bit in the **GPTMCTL** register, the timer is enabled for event capture. When the selected input event is detected, the current **Tn** counter value is captured in the **GPTMTnR** register and is available to be read by the controller. The GPTM then asserts the **CnERIS** bit (and the **CnEMIS** bit, if the interrupt is not masked).

After an event has been captured, the timer does not stop counting. It continues to count until the **TnEN** bit is cleared. When the timer reaches the 0x0000 state, it is reloaded with the value from the **GPTMnILR** register.

Figure 9-3 on page 169 shows how input edge timing mode works. In the diagram, it is assumed that the start value of the timer is the default value of 0xFFFF, and the timer is configured to capture rising edge events.

Each time a rising edge event is detected, the current count value is loaded into the **GPTMTnR** register, and is held there until another rising edge is detected (at which point the new count value is loaded into **GPTMTnR**).

Figure 9-3. 16-Bit Input Edge Time Mode Example

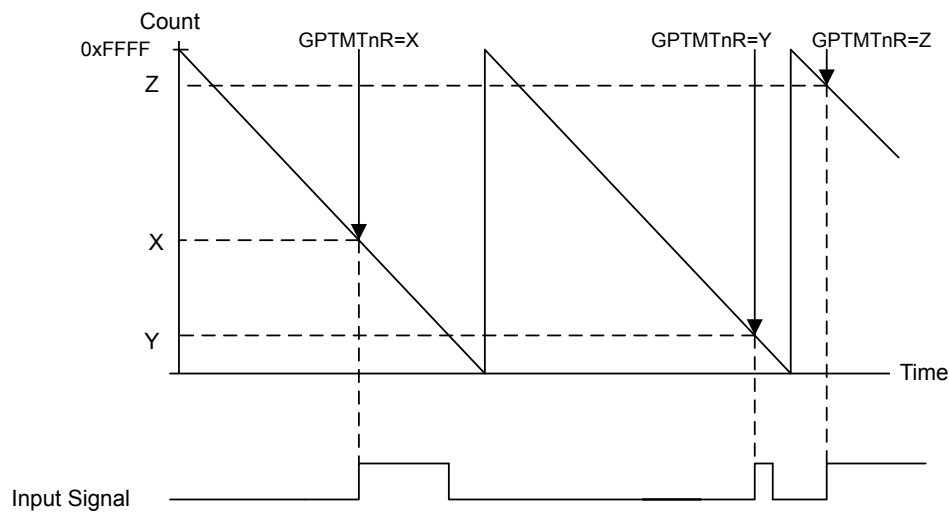

9.2.3.4 16-Bit PWM Mode

Note: The prescaler is not available in 16-Bit PWM mode.

The GPTM supports a simple PWM generation mode. In PWM mode, the timer is configured as a down-counter with a start value (and thus period) defined by **GPTMTnILR**. PWM mode is enabled with the **GPTMTnMR** register by setting the T_nAMS bit to 0x1, the T_nCMR bit to 0x0, and the T_nMR field to 0x2.

When software writes the T_nEN bit in the **GPTMCTL** register, the counter begins counting down until it reaches the 0x0000 state. On the next counter cycle, the counter reloads its start value from **GPTMTnILR** and continues counting until disabled by software clearing the T_nEN bit in the **GPTMCTL** register. No interrupts or status bits are asserted in PWM mode.

The output PWM signal asserts when the counter is at the value of the **GPTMTnILR** register (its start state), and is deasserted when the counter value equals the value in the **GPTM Timern Match Register (GPTMnMATCHR)**. Software has the capability of inverting the output PWM signal by setting the T_nPWML bit in the **GPTMCTL** register.

Figure 9-4 on page 170 shows how to generate an output PWM with a 1-ms period and a 66% duty cycle assuming a 50-MHz input clock and $T_nPWML = 0$ (duty cycle would be 33% for the $T_nPWML = 1$ configuration). For this example, the start value is **GPTMnILR=0xC350** and the match value is **GPTMnMR=0x411A**.

Figure 9-4. 16-Bit PWM Mode Example

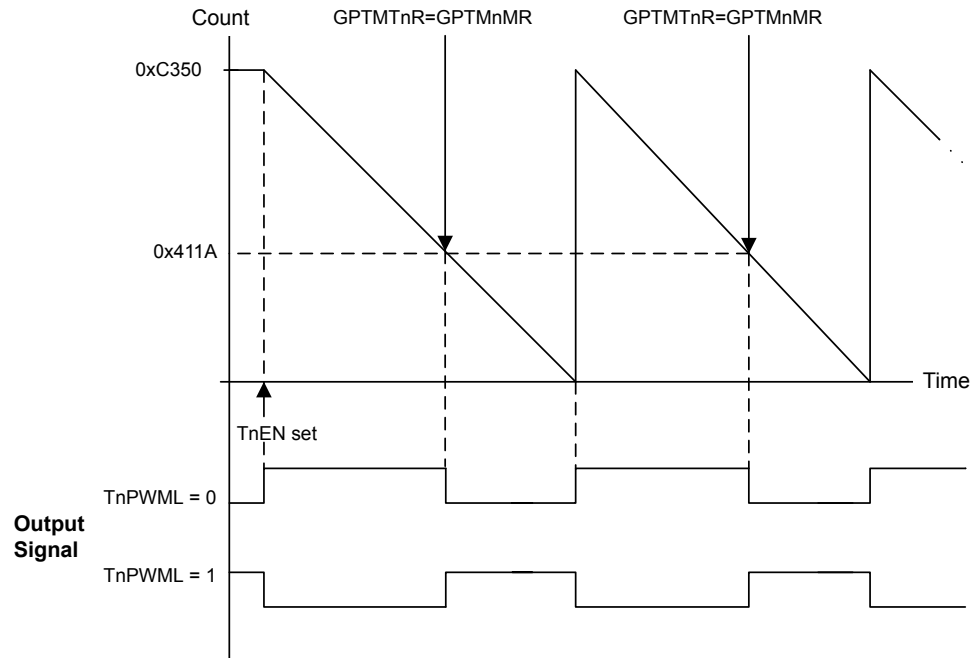

9.3 Initialization and Configuration

To use the general-purpose timers, the peripheral clock must be enabled by setting the `TIMER0`, `TIMER1`, and `TIMER2` bits in the `RCGC1` register.

This section shows module initialization and configuration examples for each of the supported timer modes.

9.3.1 32-Bit One-Shot/Periodic Timer Mode

The GPTM is configured for 32-bit One-Shot and Periodic modes by the following sequence:

1. Ensure the timer is disabled (the `TAEN` bit in the `GPTMCTL` register is cleared) before making any changes.
2. Write the **GPTM Configuration Register (GPTMCFG)** with a value of 0x0.
3. Set the `TAMR` field in the **GPTM TimerA Mode Register (GPTMTAMR)**:
 - a. Write a value of 0x1 for One-Shot mode.
 - b. Write a value of 0x2 for Periodic mode.
4. Load the start value into the **GPTM TimerA Interval Load Register (GPTMTAILR)**.
5. If interrupts are required, set the `TATOIM` bit in the **GPTM Interrupt Mask Register (GPTMIMR)**.
6. Set the `TAEN` bit in the `GPTMCTL` register to enable the timer and start counting.

7. Poll the `TATORIS` bit in the **GPTMRIS** register or wait for the interrupt to be generated (if enabled). In both cases, the status flags are cleared by writing a 1 to the `TATOCINT` bit of the **GPTM Interrupt Clear Register (GPTMICR)**.

In One-Shot mode, the timer stops counting after step 7 on page 171. To re-enable the timer, repeat the sequence. A timer configured in Periodic mode does not stop counting after it times out.

9.3.2 32-Bit Real-Time Clock (RTC) Mode

To use the RTC mode, the timer must have a 32.768-KHz input signal on its `CCP0`, `CCP2`, or `CCP4` pins. To enable the RTC feature, follow these steps:

1. Ensure the timer is disabled (the `TAEN` bit is cleared) before making any changes.
2. Write the **GPTM Configuration Register (GPTMCFG)** with a value of `0x1`.
3. Write the desired match value to the **GPTM TimerA Match Register (GPTMTAMATCHR)**.
4. Set/clear the `RTCEN` bit in the **GPTM Control Register (GPTMCTL)** as desired.
5. If interrupts are required, set the `RTCIM` bit in the **GPTM Interrupt Mask Register (GPTMIMR)**.
6. Set the `TAEN` bit in the **GPTMCTL** register to enable the timer and start counting.

When the timer count equals the value in the **GPTMTAMATCHR** register, the counter is re-loaded with `0x0000.0000` and begins counting. If an interrupt is enabled, it does not have to be cleared.

9.3.3 16-Bit One-Shot/Periodic Timer Mode

A timer is configured for 16-bit One-Shot and Periodic modes by the following sequence:

1. Ensure the timer is disabled (the `TnEN` bit is cleared) before making any changes.
2. Write the **GPTM Configuration Register (GPTMCFG)** with a value of `0x4`.
3. Set the `TnMR` field in the **GPTM Timer Mode (GPTMTnMR)** register:
 - a. Write a value of `0x1` for One-Shot mode.
 - b. Write a value of `0x2` for Periodic mode.
4. If a prescaler is to be used, write the prescale value to the **GPTM Timern Prescale Register (GPTMTnPR)**.
5. Load the start value into the **GPTM Timer Interval Load Register (GPTMTnILR)**.
6. If interrupts are required, set the `TnTOIM` bit in the **GPTM Interrupt Mask Register (GPTMIMR)**.
7. Set the `TnEN` bit in the **GPTM Control Register (GPTMCTL)** to enable the timer and start counting.
8. Poll the `TnTORIS` bit in the **GPTMRIS** register or wait for the interrupt to be generated (if enabled). In both cases, the status flags are cleared by writing a 1 to the `TnTOCINT` bit of the **GPTM Interrupt Clear Register (GPTMICR)**.

In One-Shot mode, the timer stops counting after step 8 on page 171. To re-enable the timer, repeat the sequence. A timer configured in Periodic mode does not stop counting after it times out.

9.3.4 16-Bit Input Edge Count Mode

A timer is configured to Input Edge Count mode by the following sequence:

1. Ensure the timer is disabled (the $TnEN$ bit is cleared) before making any changes.
2. Write the **GPTM Configuration (GPTMCFG)** register with a value of 0x4.
3. In the **GPTM Timer Mode (GPTMTnMR)** register, write the $TnCMR$ field to 0x0 and the $TnMR$ field to 0x3.
4. Configure the type of event(s) that the timer captures by writing the $TnEVENT$ field of the **GPTM Control (GPTMCTL)** register.
5. Load the timer start value into the **GPTM Timern Interval Load (GPTMTnILR)** register.
6. Load the desired event count into the **GPTM Timern Match (GPTMTnMATCHR)** register.
7. If interrupts are required, set the $CnMIM$ bit in the **GPTM Interrupt Mask (GPTMIMR)** register.
8. Set the $TnEN$ bit in the **GPTMCTL** register to enable the timer and begin waiting for edge events.
9. Poll the $CnMRIS$ bit in the **GPTMRIS** register or wait for the interrupt to be generated (if enabled). In both cases, the status flags are cleared by writing a 1 to the $CnMCINT$ bit of the **GPTM Interrupt Clear (GPTMICR)** register.

In Input Edge Count Mode, the timer stops after the desired number of edge events has been detected. To re-enable the timer, ensure that the $TnEN$ bit is cleared and repeat step 4 on page 172 through step 9 on page 172.

9.3.5 16-Bit Input Edge Timing Mode

A timer is configured to Input Edge Timing mode by the following sequence:

1. Ensure the timer is disabled (the $TnEN$ bit is cleared) before making any changes.
2. Write the **GPTM Configuration (GPTMCFG)** register with a value of 0x4.
3. In the **GPTM Timer Mode (GPTMTnMR)** register, write the $TnCMR$ field to 0x1 and the $TnMR$ field to 0x3.
4. Configure the type of event that the timer captures by writing the $TnEVENT$ field of the **GPTM Control (GPTMCTL)** register.
5. Load the timer start value into the **GPTM Timern Interval Load (GPTMTnILR)** register.
6. If interrupts are required, set the $CnEIM$ bit in the **GPTM Interrupt Mask (GPTMIMR)** register.
7. Set the $TnEN$ bit in the **GPTM Control (GPTMCTL)** register to enable the timer and start counting.
8. Poll the $CnERIS$ bit in the **GPTMRIS** register or wait for the interrupt to be generated (if enabled). In both cases, the status flags are cleared by writing a 1 to the $CnECINT$ bit of the **GPTM**

Interrupt Clear (GPTMICR) register. The time at which the event happened can be obtained by reading the **GPTM Timern (GPTMTnR)** register.

In Input Edge Timing mode, the timer continues running after an edge event has been detected, but the timer interval can be changed at any time by writing the **GPTMTnILR** register. The change takes effect at the next cycle after the write.

9.3.6 16-Bit PWM Mode

A timer is configured to PWM mode using the following sequence:

1. Ensure the timer is disabled (the $TnEN$ bit is cleared) before making any changes.
2. Write the **GPTM Configuration (GPTMCFG)** register with a value of 0x4.
3. In the **GPTM Timer Mode (GPTMTnMR)** register, set the $TnAMS$ bit to 0x1, the $TnCMR$ bit to 0x0, and the $TnMR$ field to 0x2.
4. Configure the output state of the PWM signal (whether or not it is inverted) in the $TnEVENT$ field of the **GPTM Control (GPTMCTL)** register.
5. Load the timer start value into the **GPTM Timern Interval Load (GPTMTnILR)** register.
6. Load the **GPTM Timern Match (GPTMTnMATCHR)** register with the desired value.
7. Set the $TnEN$ bit in the **GPTM Control (GPTMCTL)** register to enable the timer and begin generation of the output PWM signal.

In PWM Timing mode, the timer continues running after the PWM signal has been generated. The PWM period can be adjusted at any time by writing the **GPTMTnILR** register, and the change takes effect at the next cycle after the write.

9.4 Register Map

Table 9-3 on page 173 lists the GPTM registers. The offset listed is a hexadecimal increment to the register's address, relative to that timer's base address:

- Timer0: 0x4003.0000
- Timer1: 0x4003.1000
- Timer2: 0x4003.2000

Table 9-3. Timers Register Map

Offset	Name	Type	Reset	Description	See page
0x000	GPTMCFG	R/W	0x0000.0000	GPTM Configuration	175
0x004	GPTMTAMR	R/W	0x0000.0000	GPTM TimerA Mode	176
0x008	GPTMTBMR	R/W	0x0000.0000	GPTM TimerB Mode	178
0x00C	GPTMCTL	R/W	0x0000.0000	GPTM Control	180
0x018	GPTMIMR	R/W	0x0000.0000	GPTM Interrupt Mask	183

Offset	Name	Type	Reset	Description	See page
0x01C	GPTMRIS	RO	0x0000.0000	GPTM Raw Interrupt Status	185
0x020	GPTMMIS	RO	0x0000.0000	GPTM Masked Interrupt Status	186
0x024	GPTMICR	W1C	0x0000.0000	GPTM Interrupt Clear	187
0x028	GPTMTAILR	R/W	0x0000.FFFF (16-bit mode) 0xFFFF.FFFF (32-bit mode)	GPTM TimerA Interval Load	189
0x02C	GPTMTBILR	R/W	0x0000.FFFF	GPTM TimerB Interval Load	190
0x030	GPTMTAMATCHR	R/W	0x0000.FFFF (16-bit mode) 0xFFFF.FFFF (32-bit mode)	GPTM TimerA Match	191
0x034	GPTMTBMATCHR	R/W	0x0000.FFFF	GPTM TimerB Match	192
0x038	GPTMTAPR	R/W	0x0000.0000	GPTM TimerA Prescale	193
0x03C	GPTMTBPR	R/W	0x0000.0000	GPTM TimerB Prescale	194
0x040	GPTMTAPMR	R/W	0x0000.0000	GPTM TimerA Prescale Match	195
0x044	GPTMTBPMR	R/W	0x0000.0000	GPTM TimerB Prescale Match	196
0x048	GPTMTAR	RO	0x0000.FFFF (16-bit mode) 0xFFFF.FFFF (32-bit mode)	GPTM TimerA	197
0x04C	GPTMTBR	RO	0x0000.FFFF	GPTM TimerB	198

9.5 Register Descriptions

The remainder of this section lists and describes the GPTM registers, in numerical order by address offset.

Register 1: GPTM Configuration (GPTMCFG), offset 0x000

This register configures the global operation of the GPTM module. The value written to this register determines whether the GPTM is in 32- or 16-bit mode.

GPTM Configuration (GPTMCFG)

Timer0 base: 0x4003.0000
 Timer1 base: 0x4003.1000
 Timer2 base: 0x4003.2000
 Offset 0x000
 Type R/W, reset 0x0000.0000

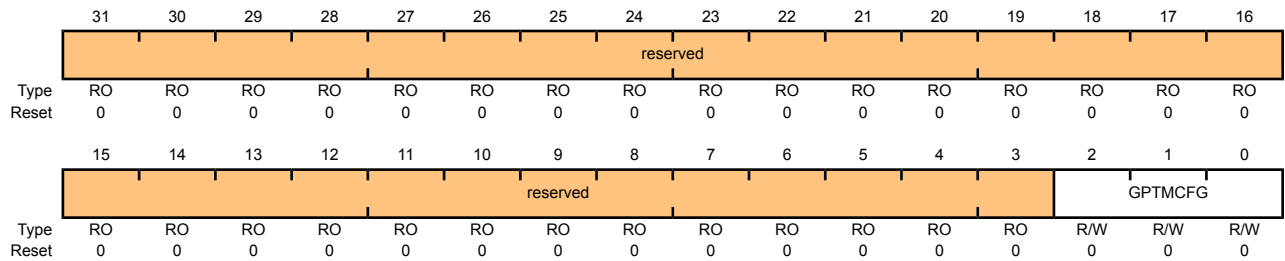

Bit/Field	Name	Type	Reset	Description
31:3	reserved	RO	0x00	Software should not rely on the value of a reserved bit. To provide compatibility with future products, the value of a reserved bit should be preserved across a read-modify-write operation.
2:0	GPTMCFG	R/W	0x0	GPTM Configuration

The GPTMCFG values are defined as follows:

Value	Description
0x0	32-bit timer configuration.
0x1	32-bit real-time clock (RTC) counter configuration.
0x2	Reserved
0x3	Reserved
0x4-0x7	16-bit timer configuration, function is controlled by bits 1:0 of GPTMTAMR and GPTMTBMR .

Register 2: GPTM TimerA Mode (GPTMTAMR), offset 0x004

This register configures the GPTM based on the configuration selected in the **GPTMCFG** register. When in 16-bit PWM mode, set the **TAAMS** bit to 0x1, the **TACMR** bit to 0x0, and the **TAMR** field to 0x2.

GPTM TimerA Mode (GPTMTAMR)

Timer0 base: 0x4003.0000
 Timer1 base: 0x4003.1000
 Timer2 base: 0x4003.2000
 Offset 0x004
 Type R/W, reset 0x0000.0000

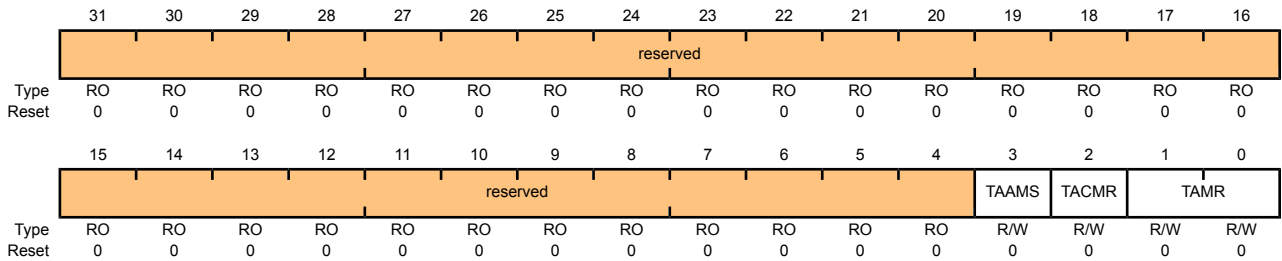

Bit/Field	Name	Type	Reset	Description
31:4	reserved	RO	0x00	Software should not rely on the value of a reserved bit. To provide compatibility with future products, the value of a reserved bit should be preserved across a read-modify-write operation.

3	TAAMS	R/W	0	GPTM TimerA Alternate Mode Select The TAAMS values are defined as follows:
---	-------	-----	---	--

Value	Description
0	Capture mode is enabled.
1	PWM mode is enabled.

Note: To enable PWM mode, you must also clear the **TACMR** bit and set the **TAMR** field to 0x2.

2	TACMR	R/W	0	GPTM TimerA Capture Mode The TACMR values are defined as follows:
---	-------	-----	---	---

Value	Description
0	Edge-Count mode
1	Edge-Time mode

Bit/Field	Name	Type	Reset	Description										
1:0	TAMR	R/W	0x0	<p>GPTM TimerA Mode</p> <p>The TAMR values are defined as follows:</p> <table><thead><tr><th>Value</th><th>Description</th></tr></thead><tbody><tr><td>0x0</td><td>Reserved</td></tr><tr><td>0x1</td><td>One-Shot Timer mode</td></tr><tr><td>0x2</td><td>Periodic Timer mode</td></tr><tr><td>0x3</td><td>Capture mode</td></tr></tbody></table> <p>The Timer mode is based on the timer configuration defined by bits 2:0 in the GPTMCFG register (16-or 32-bit).</p> <p>In 16-bit timer configuration, TAMR controls the 16-bit timer modes for TimerA.</p> <p>In 32-bit timer configuration, this register controls the mode and the contents of GPTMTBMR are ignored.</p>	Value	Description	0x0	Reserved	0x1	One-Shot Timer mode	0x2	Periodic Timer mode	0x3	Capture mode
Value	Description													
0x0	Reserved													
0x1	One-Shot Timer mode													
0x2	Periodic Timer mode													
0x3	Capture mode													

Register 3: GPTM TimerB Mode (GPTMTBMR), offset 0x008

This register configures the GPTM based on the configuration selected in the **GPTMCFG** register. When in 16-bit PWM mode, set the **TBAMS** bit to 0x1, the **TBCMR** bit to 0x0, and the **TBMR** field to 0x2.

GPTM TimerB Mode (GPTMTBMR)

Timer0 base: 0x4003.0000
 Timer1 base: 0x4003.1000
 Timer2 base: 0x4003.2000
 Offset 0x008
 Type R/W, reset 0x0000.0000

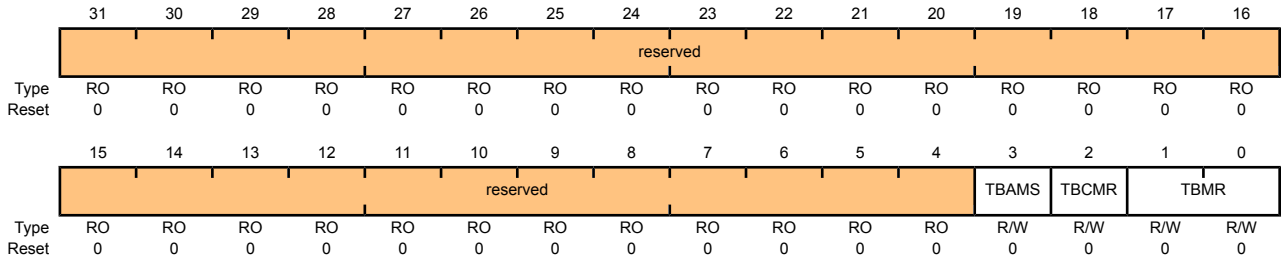

Bit/Field	Name	Type	Reset	Description
31:4	reserved	RO	0x00	Software should not rely on the value of a reserved bit. To provide compatibility with future products, the value of a reserved bit should be preserved across a read-modify-write operation.

3	TBAMS	R/W	0	GPTM TimerB Alternate Mode Select
---	-------	-----	---	-----------------------------------

The **TBAMS** values are defined as follows:

Value	Description
0	Capture mode is enabled.
1	PWM mode is enabled.

Note: To enable PWM mode, you must also clear the **TBCMR** bit and set the **TBMR** field to 0x2.

2	TBCMR	R/W	0	GPTM TimerB Capture Mode
---	-------	-----	---	--------------------------

The **TBCMR** values are defined as follows:

Value	Description
0	Edge-Count mode
1	Edge-Time mode

Bit/Field	Name	Type	Reset	Description										
1:0	TBMR	R/W	0x0	<p>GPTM TimerB Mode</p> <p>The TBMR values are defined as follows:</p> <table><thead><tr><th>Value</th><th>Description</th></tr></thead><tbody><tr><td>0x0</td><td>Reserved</td></tr><tr><td>0x1</td><td>One-Shot Timer mode</td></tr><tr><td>0x2</td><td>Periodic Timer mode</td></tr><tr><td>0x3</td><td>Capture mode</td></tr></tbody></table> <p>The timer mode is based on the timer configuration defined by bits 2:0 in the GPTMCFG register.</p> <p>In 16-bit timer configuration, these bits control the 16-bit timer modes for TimerB.</p> <p>In 32-bit timer configuration, this register's contents are ignored and GPTMTAMR is used.</p>	Value	Description	0x0	Reserved	0x1	One-Shot Timer mode	0x2	Periodic Timer mode	0x3	Capture mode
Value	Description													
0x0	Reserved													
0x1	One-Shot Timer mode													
0x2	Periodic Timer mode													
0x3	Capture mode													

Register 4: GPTM Control (GPTMCTL), offset 0x00C

This register is used alongside the **GPTMCFG** and **GMTMTnMR** registers to fine-tune the timer configuration, and to enable other features such as timer stall and the output trigger. The output trigger can be used to initiate transfers on the ADC module.

GPTM Control (GPTMCTL)

Timer0 base: 0x4003.0000
 Timer1 base: 0x4003.1000
 Timer2 base: 0x4003.2000
 Offset 0x00C
 Type R/W, reset 0x0000.0000

	31	30	29	28	27	26	25	24	23	22	21	20	19	18	17	16
	reserved															
Type	RO	RO	RO	RO	RO	RO	RO	RO	RO	RO	RO	RO	RO	RO	RO	RO
Reset	0	0	0	0	0	0	0	0	0	0	0	0	0	0	0	0
	15	14	13	12	11	10	9	8	7	6	5	4	3	2	1	0
	reserved	TBPWML	TBOTE	reserved	TBEVENT	TBSTALL	TBEN	reserved	TAPWML	TAOTE	RTCEN	TAEVENT	TASTALL	TAEN		
Type	RO	R/W	R/W	RO	R/W	R/W	R/W	R/W	RO	R/W	R/W	R/W	R/W	R/W	R/W	R/W
Reset	0	0	0	0	0	0	0	0	0	0	0	0	0	0	0	0

Bit/Field	Name	Type	Reset	Description
31:15	reserved	RO	0x00	Software should not rely on the value of a reserved bit. To provide compatibility with future products, the value of a reserved bit should be preserved across a read-modify-write operation.
14	TBPWML	R/W	0	GPTM TimerB PWM Output Level The TBPWML values are defined as follows: Value Description 0 Output is unaffected. 1 Output is inverted.
13	TBOTE	R/W	0	GPTM TimerB Output Trigger Enable The TBOTE values are defined as follows: Value Description 0 The output TimerB trigger is disabled. 1 The output TimerB trigger is enabled.
12	reserved	RO	0	Software should not rely on the value of a reserved bit. To provide compatibility with future products, the value of a reserved bit should be preserved across a read-modify-write operation.

Bit/Field	Name	Type	Reset	Description										
11:10	TBEVENT	R/W	0x0	<p>GPTM TimerB Event Mode</p> <p>The TBEVENT values are defined as follows:</p> <table border="1"> <thead> <tr> <th>Value</th> <th>Description</th> </tr> </thead> <tbody> <tr> <td>0x0</td> <td>Positive edge</td> </tr> <tr> <td>0x1</td> <td>Negative edge</td> </tr> <tr> <td>0x2</td> <td>Reserved</td> </tr> <tr> <td>0x3</td> <td>Both edges</td> </tr> </tbody> </table>	Value	Description	0x0	Positive edge	0x1	Negative edge	0x2	Reserved	0x3	Both edges
Value	Description													
0x0	Positive edge													
0x1	Negative edge													
0x2	Reserved													
0x3	Both edges													
9	TBSTALL	R/W	0	<p>GPTM TimerB Stall Enable</p> <p>The TBSTALL values are defined as follows:</p> <table border="1"> <thead> <tr> <th>Value</th> <th>Description</th> </tr> </thead> <tbody> <tr> <td>0</td> <td>TimerB stalling is disabled.</td> </tr> <tr> <td>1</td> <td>TimerB stalling is enabled.</td> </tr> </tbody> </table>	Value	Description	0	TimerB stalling is disabled.	1	TimerB stalling is enabled.				
Value	Description													
0	TimerB stalling is disabled.													
1	TimerB stalling is enabled.													
8	TBEN	R/W	0	<p>GPTM TimerB Enable</p> <p>The TBEN values are defined as follows:</p> <table border="1"> <thead> <tr> <th>Value</th> <th>Description</th> </tr> </thead> <tbody> <tr> <td>0</td> <td>TimerB is disabled.</td> </tr> <tr> <td>1</td> <td>TimerB is enabled and begins counting or the capture logic is enabled based on the GPTMCFG register.</td> </tr> </tbody> </table>	Value	Description	0	TimerB is disabled.	1	TimerB is enabled and begins counting or the capture logic is enabled based on the GPTMCFG register.				
Value	Description													
0	TimerB is disabled.													
1	TimerB is enabled and begins counting or the capture logic is enabled based on the GPTMCFG register.													
7	reserved	RO	0	Software should not rely on the value of a reserved bit. To provide compatibility with future products, the value of a reserved bit should be preserved across a read-modify-write operation.										
6	TAPWML	R/W	0	<p>GPTM TimerA PWM Output Level</p> <p>The TAPWML values are defined as follows:</p> <table border="1"> <thead> <tr> <th>Value</th> <th>Description</th> </tr> </thead> <tbody> <tr> <td>0</td> <td>Output is unaffected.</td> </tr> <tr> <td>1</td> <td>Output is inverted.</td> </tr> </tbody> </table>	Value	Description	0	Output is unaffected.	1	Output is inverted.				
Value	Description													
0	Output is unaffected.													
1	Output is inverted.													
5	TAOTE	R/W	0	<p>GPTM TimerA Output Trigger Enable</p> <p>The TAOTE values are defined as follows:</p> <table border="1"> <thead> <tr> <th>Value</th> <th>Description</th> </tr> </thead> <tbody> <tr> <td>0</td> <td>The output TimerA trigger is disabled.</td> </tr> <tr> <td>1</td> <td>The output TimerA trigger is enabled.</td> </tr> </tbody> </table>	Value	Description	0	The output TimerA trigger is disabled.	1	The output TimerA trigger is enabled.				
Value	Description													
0	The output TimerA trigger is disabled.													
1	The output TimerA trigger is enabled.													

Bit/Field	Name	Type	Reset	Description
4	RTCEN	R/W	0	GPTM RTC Enable The <code>RTCEN</code> values are defined as follows: Value Description 0 RTC counting is disabled. 1 RTC counting is enabled.
3:2	TAEVENT	R/W	0x0	GPTM TimerA Event Mode The <code>TAEVENT</code> values are defined as follows: Value Description 0x0 Positive edge 0x1 Negative edge 0x2 Reserved 0x3 Both edges
1	TASTALL	R/W	0	GPTM TimerA Stall Enable The <code>TASTALL</code> values are defined as follows: Value Description 0 TimerA stalling is disabled. 1 TimerA stalling is enabled.
0	TAEN	R/W	0	GPTM TimerA Enable The <code>TAEN</code> values are defined as follows: Value Description 0 TimerA is disabled. 1 TimerA is enabled and begins counting or the capture logic is enabled based on the <code>GPTMCFG</code> register.

Register 5: GPTM Interrupt Mask (GPTMIMR), offset 0x018

This register allows software to enable/disable GPTM controller-level interrupts. Writing a 1 enables the interrupt, while writing a 0 disables it.

GPTM Interrupt Mask (GPTMIMR)

Timer0 base: 0x4003.0000
 Timer1 base: 0x4003.1000
 Timer2 base: 0x4003.2000
 Offset 0x018
 Type R/W, reset 0x0000.0000

	31	30	29	28	27	26	25	24	23	22	21	20	19	18	17	16
	reserved															
Type	RO	RO	RO	RO	RO	RO	RO	RO	RO	RO	RO	RO	RO	RO	RO	RO
Reset	0	0	0	0	0	0	0	0	0	0	0	0	0	0	0	0
	15	14	13	12	11	10	9	8	7	6	5	4	3	2	1	0
	reserved				CBEIM	CBMIM	TBTOIM	reserved				RTCIM	CAEIM	CAMIM	TATOIM	
Type	RO	RO	RO	RO	RO	R/W	R/W	R/W	RO	RO	RO	RO	R/W	R/W	R/W	R/W
Reset	0	0	0	0	0	0	0	0	0	0	0	0	0	0	0	0

Bit/Field	Name	Type	Reset	Description
31:11	reserved	RO	0x00	Software should not rely on the value of a reserved bit. To provide compatibility with future products, the value of a reserved bit should be preserved across a read-modify-write operation.
10	CBEIM	R/W	0	GPTM CaptureB Event Interrupt Mask The CBEIM values are defined as follows: Value Description 0 Interrupt is disabled. 1 Interrupt is enabled.
9	CBMIM	R/W	0	GPTM CaptureB Match Interrupt Mask The CBMIM values are defined as follows: Value Description 0 Interrupt is disabled. 1 Interrupt is enabled.
8	TBTOIM	R/W	0	GPTM TimerB Time-Out Interrupt Mask The TBTOIM values are defined as follows: Value Description 0 Interrupt is disabled. 1 Interrupt is enabled.
7:4	reserved	RO	0	Software should not rely on the value of a reserved bit. To provide compatibility with future products, the value of a reserved bit should be preserved across a read-modify-write operation.

Bit/Field	Name	Type	Reset	Description
3	RTCIM	R/W	0	GPTM RTC Interrupt Mask The RTCIM values are defined as follows: Value Description 0 Interrupt is disabled. 1 Interrupt is enabled.
2	CAEIM	R/W	0	GPTM CaptureA Event Interrupt Mask The CAEIM values are defined as follows: Value Description 0 Interrupt is disabled. 1 Interrupt is enabled.
1	CAMIM	R/W	0	GPTM CaptureA Match Interrupt Mask The CAMIM values are defined as follows: Value Description 0 Interrupt is disabled. 1 Interrupt is enabled.
0	TATOIM	R/W	0	GPTM TimerA Time-Out Interrupt Mask The TATOIM values are defined as follows: Value Description 0 Interrupt is disabled. 1 Interrupt is enabled.

Register 6: GPTM Raw Interrupt Status (GPTMRIS), offset 0x01C

This register shows the state of the GPTM's internal interrupt signal. These bits are set whether or not the interrupt is masked in the **GPTMIMR** register. Each bit can be cleared by writing a 1 to its corresponding bit in **GPTMICR**.

GPTM Raw Interrupt Status (GPTMRIS)

Timer0 base: 0x4003.0000
 Timer1 base: 0x4003.1000
 Timer2 base: 0x4003.2000
 Offset 0x01C
 Type RO, reset 0x0000.0000

	31	30	29	28	27	26	25	24	23	22	21	20	19	18	17	16
	reserved															
Type	RO	RO	RO	RO	RO	RO	RO	RO	RO	RO	RO	RO	RO	RO	RO	RO
Reset	0	0	0	0	0	0	0	0	0	0	0	0	0	0	0	0
	15	14	13	12	11	10	9	8	7	6	5	4	3	2	1	0
	reserved				CBERIS	CBMRIS	TBTORIS	reserved				RTCRIS	CAERIS	CAMRIS	TATORIS	
Type	RO	RO	RO	RO	RO	RO	RO	RO	RO	RO	RO	RO	RO	RO	RO	RO
Reset	0	0	0	0	0	0	0	0	0	0	0	0	0	0	0	0

Bit/Field	Name	Type	Reset	Description
31:11	reserved	RO	0x00	Software should not rely on the value of a reserved bit. To provide compatibility with future products, the value of a reserved bit should be preserved across a read-modify-write operation.
10	CBERIS	RO	0	GPTM CaptureB Event Raw Interrupt This is the CaptureB Event interrupt status prior to masking.
9	CBMRIS	RO	0	GPTM CaptureB Match Raw Interrupt This is the CaptureB Match interrupt status prior to masking.
8	TBTORIS	RO	0	GPTM TimerB Time-Out Raw Interrupt This is the TimerB time-out interrupt status prior to masking.
7:4	reserved	RO	0x0	Software should not rely on the value of a reserved bit. To provide compatibility with future products, the value of a reserved bit should be preserved across a read-modify-write operation.
3	RTCRIS	RO	0	GPTM RTC Raw Interrupt This is the RTC Event interrupt status prior to masking.
2	CAERIS	RO	0	GPTM CaptureA Event Raw Interrupt This is the CaptureA Event interrupt status prior to masking.
1	CAMRIS	RO	0	GPTM CaptureA Match Raw Interrupt This is the CaptureA Match interrupt status prior to masking.
0	TATORIS	RO	0	GPTM TimerA Time-Out Raw Interrupt This the TimerA time-out interrupt status prior to masking.

Register 7: GPTM Masked Interrupt Status (GPTMMIS), offset 0x020

This register show the state of the GPTM's controller-level interrupt. If an interrupt is unmasked in **GPTMIMR**, and there is an event that causes the interrupt to be asserted, the corresponding bit is set in this register. All bits are cleared by writing a 1 to the corresponding bit in **GPTMICR**.

GPTM Masked Interrupt Status (GPTMMIS)

Timer0 base: 0x4003.0000
 Timer1 base: 0x4003.1000
 Timer2 base: 0x4003.2000
 Offset 0x020
 Type RO, reset 0x0000.0000

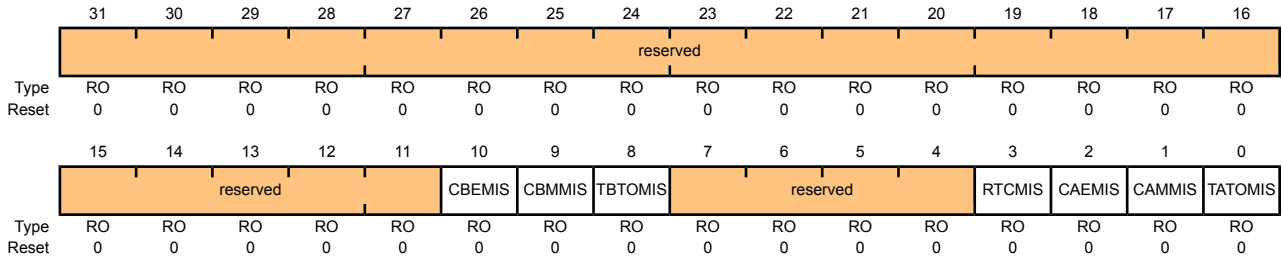

Bit/Field	Name	Type	Reset	Description
31:11	reserved	RO	0x00	Software should not rely on the value of a reserved bit. To provide compatibility with future products, the value of a reserved bit should be preserved across a read-modify-write operation.
10	CBEMIS	RO	0	GPTM CaptureB Event Masked Interrupt This is the CaptureB event interrupt status after masking.
9	CBMMIS	RO	0	GPTM CaptureB Match Masked Interrupt This is the CaptureB match interrupt status after masking.
8	TBTOMIS	RO	0	GPTM TimerB Time-Out Masked Interrupt This is the TimerB time-out interrupt status after masking.
7:4	reserved	RO	0x0	Software should not rely on the value of a reserved bit. To provide compatibility with future products, the value of a reserved bit should be preserved across a read-modify-write operation.
3	RTCMIS	RO	0	GPTM RTC Masked Interrupt This is the RTC event interrupt status after masking.
2	CAEMIS	RO	0	GPTM CaptureA Event Masked Interrupt This is the CaptureA event interrupt status after masking.
1	CAMMIS	RO	0	GPTM CaptureA Match Masked Interrupt This is the CaptureA match interrupt status after masking.
0	TATOMIS	RO	0	GPTM TimerA Time-Out Masked Interrupt This is the TimerA time-out interrupt status after masking.

Register 8: GPTM Interrupt Clear (GPTMICR), offset 0x024

This register is used to clear the status bits in the **GPTMRIS** and **GPTMMIS** registers. Writing a 1 to a bit clears the corresponding bit in the **GPTMRIS** and **GPTMMIS** registers.

GPTM Interrupt Clear (GPTMICR)

Timer0 base: 0x4003.0000
 Timer1 base: 0x4003.1000
 Timer2 base: 0x4003.2000
 Offset 0x024
 Type W1C, reset 0x0000.0000

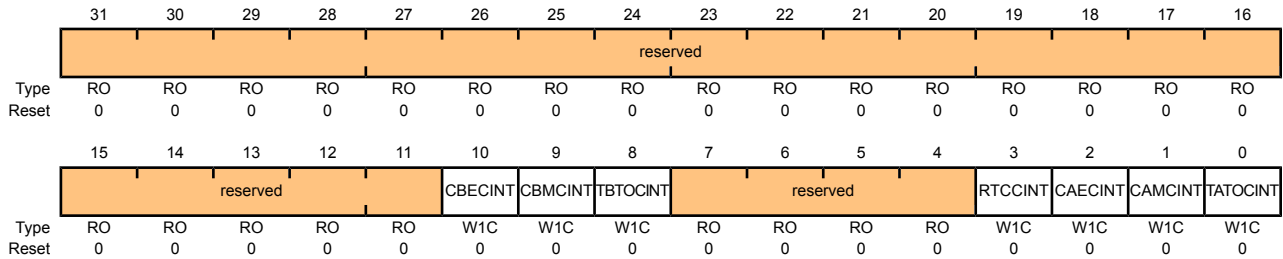

Bit/Field	Name	Type	Reset	Description
31:11	reserved	RO	0x00	Software should not rely on the value of a reserved bit. To provide compatibility with future products, the value of a reserved bit should be preserved across a read-modify-write operation.
10	CBECINT	W1C	0	GPTM CaptureB Event Interrupt Clear The CBECINT values are defined as follows: Value Description 0 The interrupt is unaffected. 1 The interrupt is cleared.
9	CBMCINT	W1C	0	GPTM CaptureB Match Interrupt Clear The CBMCINT values are defined as follows: Value Description 0 The interrupt is unaffected. 1 The interrupt is cleared.
8	TBOCINT	W1C	0	GPTM TimerB Time-Out Interrupt Clear The TBOCINT values are defined as follows: Value Description 0 The interrupt is unaffected. 1 The interrupt is cleared.
7:4	reserved	RO	0x0	Software should not rely on the value of a reserved bit. To provide compatibility with future products, the value of a reserved bit should be preserved across a read-modify-write operation.

Bit/Field	Name	Type	Reset	Description
3	RTCCINT	W1C	0	GPTM RTC Interrupt Clear The RTCCINT values are defined as follows: Value Description 0 The interrupt is unaffected. 1 The interrupt is cleared.
2	CAECINT	W1C	0	GPTM CaptureA Event Interrupt Clear The CAECINT values are defined as follows: Value Description 0 The interrupt is unaffected. 1 The interrupt is cleared.
1	CAMCINT	W1C	0	GPTM CaptureA Match Raw Interrupt This is the CaptureA match interrupt status after masking.
0	TATOCINT	W1C	0	GPTM TimerA Time-Out Raw Interrupt The TATOCINT values are defined as follows: Value Description 0 The interrupt is unaffected. 1 The interrupt is cleared.

Register 9: GPTM TimerA Interval Load (GPTMTAILR), offset 0x028

This register is used to load the starting count value into the timer. When GPTM is configured to one of the 32-bit modes, **GPTMTAILR** appears as a 32-bit register (the upper 16-bits correspond to the contents of the **GPTM TimerB Interval Load (GPTMTBILR)** register). In 16-bit mode, the upper 16 bits of this register read as 0s and have no effect on the state of **GPTMTBILR**.

GPTM TimerA Interval Load (GPTMTAILR)

Timer0 base: 0x4003.0000

Timer1 base: 0x4003.1000

Timer2 base: 0x4003.2000

Offset 0x028

Type R/W, reset 0x0000.FFFF (16-bit mode) and 0xFFFF.FFFF (32-bit mode)

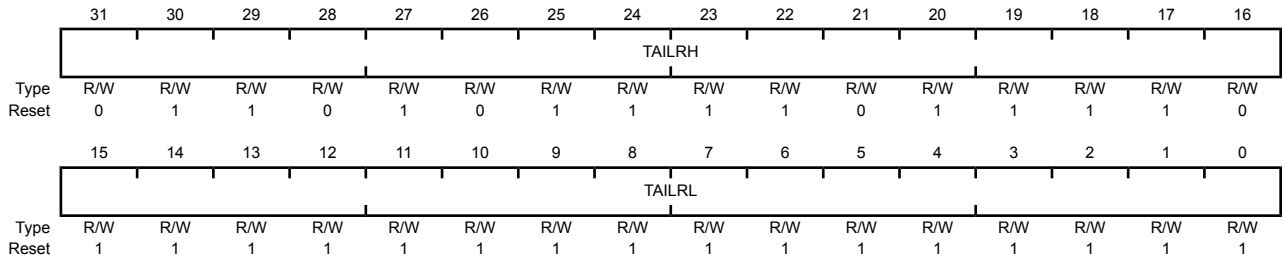

Bit/Field	Name	Type	Reset	Description
31:16	TAILRH	R/W	0xFFFF (32-bit mode) 0x0000 (16-bit mode)	GPTM TimerA Interval Load Register High When configured for 32-bit mode via the GPTMCFG register, the GPTM TimerB Interval Load (GPTMTBILR) register loads this value on a write. A read returns the current value of GPTMTBILR . In 16-bit mode, this field reads as 0 and does not have an effect on the state of GPTMTBILR .
15:0	TAILRL	R/W	0xFFFF	GPTM TimerA Interval Load Register Low For both 16- and 32-bit modes, writing this field loads the counter for TimerA. A read returns the current value of GPTMTAILR .

Register 10: GPTM TimerB Interval Load (GPTMTBILR), offset 0x02C

This register is used to load the starting count value into TimerB. When the GPTM is configured to a 32-bit mode, **GPTMTBILR** returns the current value of TimerB and ignores writes.

GPTM TimerB Interval Load (GPTMTBILR)

Timer0 base: 0x4003.0000
 Timer1 base: 0x4003.1000
 Timer2 base: 0x4003.2000
 Offset 0x02C
 Type R/W, reset 0x0000.FFFF

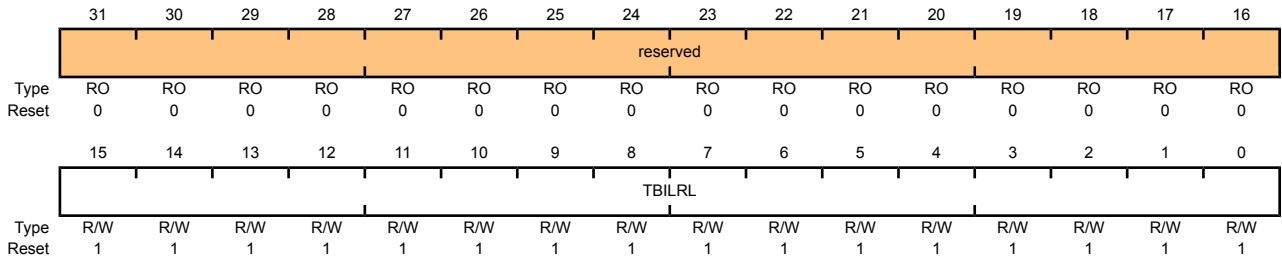

Bit/Field	Name	Type	Reset	Description
31:16	reserved	RO	0x0000	Software should not rely on the value of a reserved bit. To provide compatibility with future products, the value of a reserved bit should be preserved across a read-modify-write operation.
15:0	TBILRL	R/W	0xFFFF	GPTM TimerB Interval Load Register

When the GPTM is not configured as a 32-bit timer, a write to this field updates **GPTMTBILR**. In 32-bit mode, writes are ignored, and reads return the current value of **GPTMTBILR**.

Register 11: GPTM TimerA Match (GPTMTAMATCHR), offset 0x030

This register is used in 32-bit Real-Time Clock mode and 16-bit PWM and Input Edge Count modes.

GPTM TimerA Match (GPTMTAMATCHR)

Timer0 base: 0x4003.0000

Timer1 base: 0x4003.1000

Timer2 base: 0x4003.2000

Offset 0x030

Type R/W, reset 0x0000.FFFF (16-bit mode) and 0xFFFF.FFFF (32-bit mode)

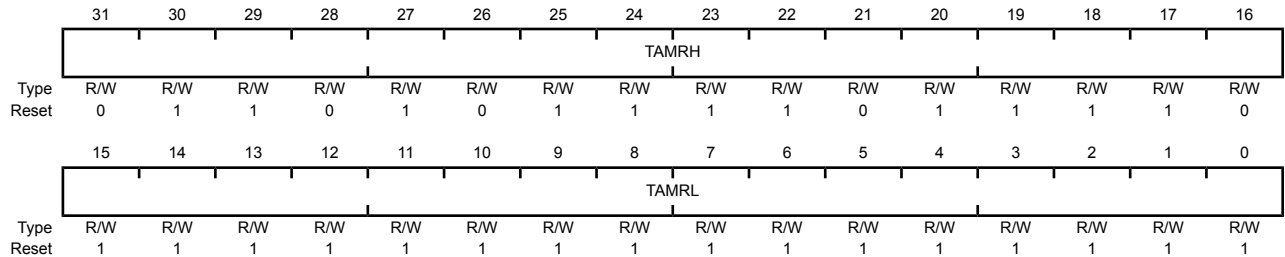

Bit/Field	Name	Type	Reset	Description
31:16	TAMRH	R/W	0xFFFF (32-bit mode) 0x0000 (16-bit mode)	GPTM TimerA Match Register High When configured for 32-bit Real-Time Clock (RTC) mode via the GPTMCFG register, this value is compared to the upper half of GPTMTAR , to determine match events. In 16-bit mode, this field reads as 0 and does not have an effect on the state of GPTMTBMATCHR .
15:0	TAMRL	R/W	0xFFFF	GPTM TimerA Match Register Low When configured for 32-bit Real-Time Clock (RTC) mode via the GPTMCFG register, this value is compared to the lower half of GPTMTAR , to determine match events. When configured for PWM mode, this value along with GPTMTAILR , determines the duty cycle of the output PWM signal. When configured for Edge Count mode, this value along with GPTMTAILR , determines how many edge events are counted. The total number of edge events counted is equal to the value in GPTMTAILR minus this value.

Register 12: GPTM TimerB Match (GPTMTBMATCHR), offset 0x034

This register is used in 16-bit PWM and Input Edge Count modes.

GPTM TimerB Match (GPTMTBMATCHR)

Timer0 base: 0x4003.0000
 Timer1 base: 0x4003.1000
 Timer2 base: 0x4003.2000
 Offset 0x034
 Type R/W, reset 0x0000.FFFF

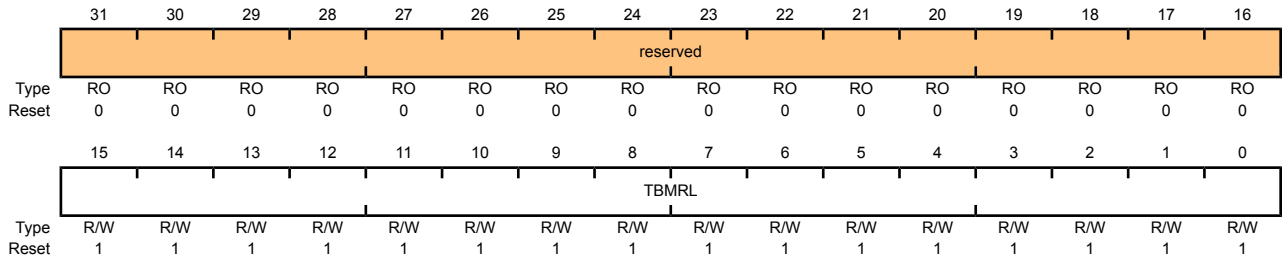

Bit/Field	Name	Type	Reset	Description
31:16	reserved	RO	0x0000	Software should not rely on the value of a reserved bit. To provide compatibility with future products, the value of a reserved bit should be preserved across a read-modify-write operation.
15:0	TBMRL	R/W	0xFFFF	GPTM TimerB Match Register Low When configured for PWM mode, this value along with GPTMTBILR , determines the duty cycle of the output PWM signal. When configured for Edge Count mode, this value along with GPTMTBILR , determines how many edge events are counted. The total number of edge events counted is equal to the value in GPTMTBILR minus this value.

Register 13: GPTM TimerA Prescale (GPTMTAPR), offset 0x038

This register allows software to extend the range of the 16-bit timers when operating in one-shot or periodic mode.

GPTM TimerA Prescale (GPTMTAPR)

Timer0 base: 0x4003.0000
 Timer1 base: 0x4003.1000
 Timer2 base: 0x4003.2000
 Offset 0x038
 Type R/W, reset 0x0000.0000

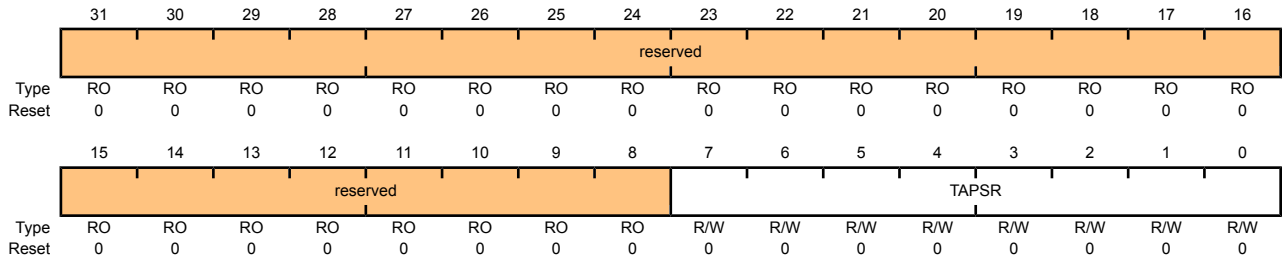

Bit/Field	Name	Type	Reset	Description
31:8	reserved	RO	0x00	Software should not rely on the value of a reserved bit. To provide compatibility with future products, the value of a reserved bit should be preserved across a read-modify-write operation.
7:0	TAPSR	R/W	0x00	GPTM TimerA Prescale The register loads this value on a write. A read returns the current value of the register. Refer to Table 9-2 on page 167 for more details and an example.

Register 14: GPTM TimerB Prescale (GPTMTBPR), offset 0x03C

This register allows software to extend the range of the 16-bit timers when operating in one-shot or periodic mode.

GPTM TimerB Prescale (GPTMTBPR)

Timer0 base: 0x4003.0000
 Timer1 base: 0x4003.1000
 Timer2 base: 0x4003.2000
 Offset 0x03C
 Type R/W, reset 0x0000.0000

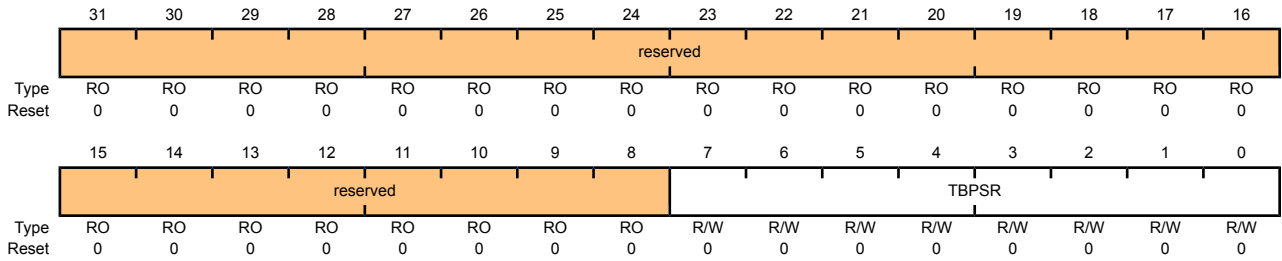

Bit/Field	Name	Type	Reset	Description
31:8	reserved	RO	0x00	Software should not rely on the value of a reserved bit. To provide compatibility with future products, the value of a reserved bit should be preserved across a read-modify-write operation.
7:0	TBPSR	R/W	0x00	GPTM TimerB Prescale The register loads this value on a write. A read returns the current value of this register. Refer to Table 9-2 on page 167 for more details and an example.

Register 15: GPTM TimerA Prescale Match (GPTMTAPMR), offset 0x040

This register effectively extends the range of **GPTMTAMATCHR** to 24 bits when operating in 16-bit one-shot or periodic mode.

GPTM TimerA Prescale Match (GPTMTAPMR)

Timer0 base: 0x4003.0000
 Timer1 base: 0x4003.1000
 Timer2 base: 0x4003.2000
 Offset 0x040
 Type R/W, reset 0x0000.0000

	31	30	29	28	27	26	25	24	23	22	21	20	19	18	17	16
	reserved															
Type	RO	RO	RO	RO	RO	RO	RO	RO	RO	RO	RO	RO	RO	RO	RO	RO
Reset	0	0	0	0	0	0	0	0	0	0	0	0	0	0	0	0
	15	14	13	12	11	10	9	8	7	6	5	4	3	2	1	0
	reserved								TAPSMR							
Type	RO	RO	RO	RO	RO	RO	RO	RO	R/W	R/W	R/W	R/W	R/W	R/W	R/W	R/W
Reset	0	0	0	0	0	0	0	0	0	0	0	0	0	0	0	0

Bit/Field	Name	Type	Reset	Description
31:8	reserved	RO	0x00	Software should not rely on the value of a reserved bit. To provide compatibility with future products, the value of a reserved bit should be preserved across a read-modify-write operation.
7:0	TAPSMR	R/W	0x00	GPTM TimerA Prescale Match This value is used alongside GPTMTAMATCHR to detect timer match events while using a prescaler.

Register 16: GPTM TimerB Prescale Match (GPTMTBPMR), offset 0x044

This register effectively extends the range of **GPTMTBMATCHR** to 24 bits when operating in 16-bit one-shot or periodic mode.

GPTM TimerB Prescale Match (GPTMTBPMR)

Timer0 base: 0x4003.0000
 Timer1 base: 0x4003.1000
 Timer2 base: 0x4003.2000
 Offset 0x044
 Type R/W, reset 0x0000.0000

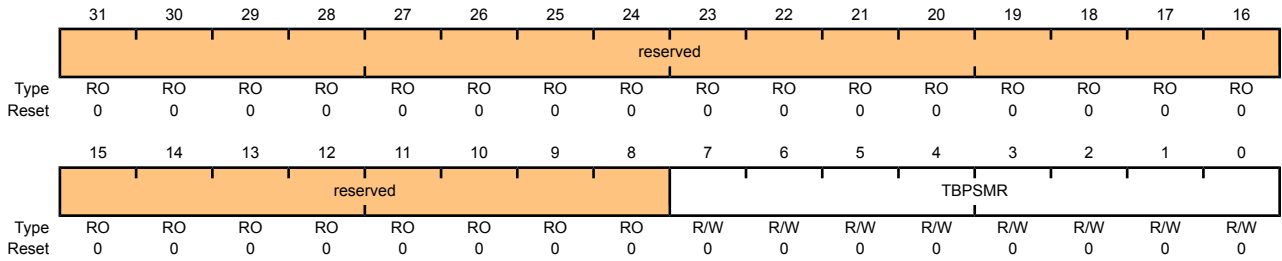

Bit/Field	Name	Type	Reset	Description
31:8	reserved	RO	0x00	Software should not rely on the value of a reserved bit. To provide compatibility with future products, the value of a reserved bit should be preserved across a read-modify-write operation.
7:0	TBPSMR	R/W	0x00	GPTM TimerB Prescale Match This value is used alongside GPTMTBMATCHR to detect timer match events while using a prescaler.

Register 17: GPTM TimerA (GPTMTAR), offset 0x048

This register shows the current value of the TimerA counter in all cases except for Input Edge Count mode. When in this mode, this register contains the time at which the last edge event took place.

GPTM TimerA (GPTMTAR)

Timer0 base: 0x4003.0000

Timer1 base: 0x4003.1000

Timer2 base: 0x4003.2000

Offset 0x048

Type RO, reset 0x0000.FFFF (16-bit mode) and 0xFFFF.FFFF (32-bit mode)

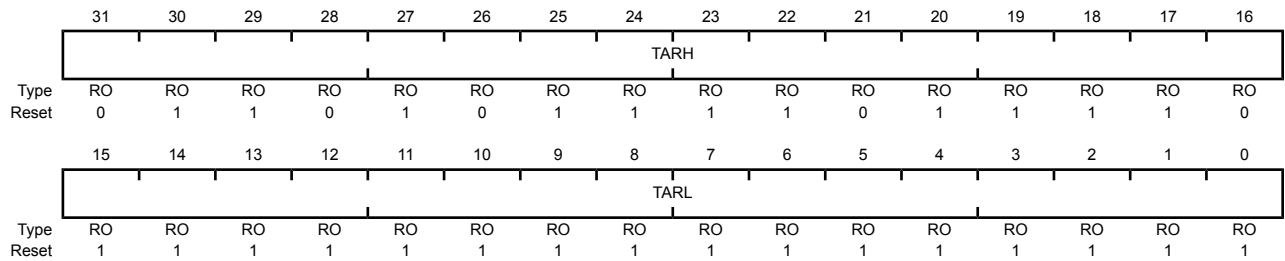

Bit/Field	Name	Type	Reset	Description
31:16	TARH	RO	0xFFFF (32-bit mode) 0x0000 (16-bit mode)	GPTM TimerA Register High If the GPTMCFG is in a 32-bit mode, TimerB value is read. If the GPTMCFG is in a 16-bit mode, this is read as zero.
15:0	TARL	RO	0xFFFF	GPTM TimerA Register Low

A read returns the current value of the **GPTM TimerA Count Register**, except in Input Edge Count mode, when it returns the timestamp from the last edge event.

Register 18: GPTM TimerB (GPTMTBR), offset 0x04C

This register shows the current value of the TimerB counter in all cases except for Input Edge Count mode. When in this mode, this register contains the time at which the last edge event took place.

GPTM TimerB (GPTMTBR)

Timer0 base: 0x4003.0000
 Timer1 base: 0x4003.1000
 Timer2 base: 0x4003.2000
 Offset 0x04C
 Type RO, reset 0x0000.FFFF

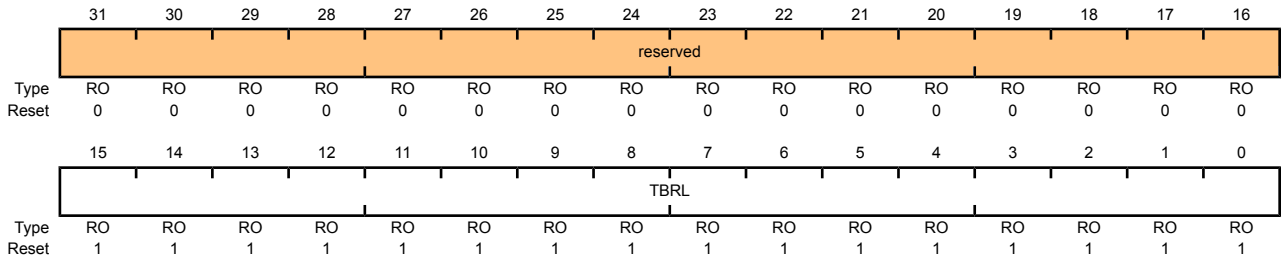

Bit/Field	Name	Type	Reset	Description
31:16	reserved	RO	0x0000	Software should not rely on the value of a reserved bit. To provide compatibility with future products, the value of a reserved bit should be preserved across a read-modify-write operation.
15:0	TBRL	RO	0xFFFF	GPTM TimerB

A read returns the current value of the **GPTM TimerB Count Register**, except in Input Edge Count mode, when it returns the timestamp from the last edge event.

10 Watchdog Timer

A watchdog timer can generate nonmaskable interrupts (NMIs) or a reset when a time-out value is reached. The watchdog timer is used to regain control when a system has failed due to a software error or due to the failure of an external device to respond in the expected way.

The Stellaris® Watchdog Timer module consists of a 32-bit down counter, a programmable load register, interrupt generation logic, a locking register, and user-enabled stalling.

The Watchdog Timer can be configured to generate an interrupt to the controller on its first time-out, and to generate a reset signal on its second time-out. Once the Watchdog Timer has been configured, the lock register can be written to prevent the timer configuration from being inadvertently altered.

10.1 Block Diagram

Figure 10-1. WDT Module Block Diagram

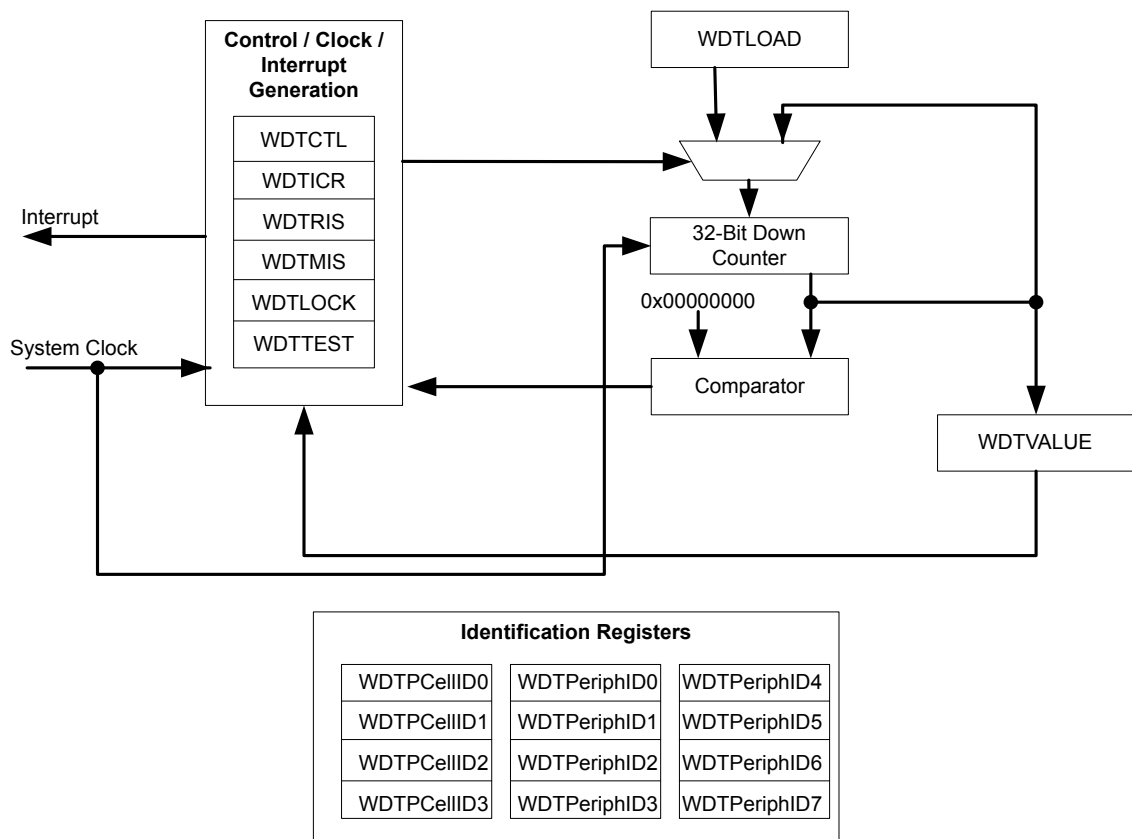

10.2 Functional Description

The Watchdog Timer module generates the first time-out signal when the 32-bit counter reaches the zero state after being enabled; enabling the counter also enables the watchdog timer interrupt. After the first time-out event, the 32-bit counter is re-loaded with the value of the **Watchdog Timer Load (WDTLOAD)** register, and the timer resumes counting down from that value. Once the

Watchdog Timer has been configured, the **Watchdog Timer Lock (WDTLOCK)** register is written, which prevents the timer configuration from being inadvertently altered by software.

If the timer counts down to its zero state again before the first time-out interrupt is cleared, and the reset signal has been enabled (via the `WatchdogResetEnable` function), the Watchdog timer asserts its reset signal to the system. If the interrupt is cleared before the 32-bit counter reaches its second time-out, the 32-bit counter is loaded with the value in the **WDTLOAD** register, and counting resumes from that value.

If **WDTLOAD** is written with a new value while the Watchdog Timer counter is counting, then the counter is loaded with the new value and continues counting.

Writing to **WDTLOAD** does not clear an active interrupt. An interrupt must be specifically cleared by writing to the **Watchdog Interrupt Clear (WDTICR)** register.

The Watchdog module interrupt and reset generation can be enabled or disabled as required. When the interrupt is re-enabled, the 32-bit counter is preloaded with the load register value and not its last state.

10.3 Initialization and Configuration

To use the WDT, its peripheral clock must be enabled by setting the `WDT` bit in the **RCGC0** register. The Watchdog Timer is configured using the following sequence:

1. Load the **WDTLOAD** register with the desired timer load value.
2. If the Watchdog is configured to trigger system resets, set the `RESEN` bit in the **WDTCTL** register.
3. Set the `INTEN` bit in the **WDTCTL** register to enable the Watchdog and lock the control register.

If software requires that all of the watchdog registers are locked, the Watchdog Timer module can be fully locked by writing any value to the **WDTLOCK** register. To unlock the Watchdog Timer, write a value of `0x1ACC.E551`.

10.4 Register Map

Table 10-1 on page 200 lists the Watchdog registers. The offset listed is a hexadecimal increment to the register's address, relative to the Watchdog Timer base address of `0x4000.0000`.

Table 10-1. Watchdog Timer Register Map

Offset	Name	Type	Reset	Description	See page
0x000	WDTLOAD	R/W	0xFFFF.FFFF	Watchdog Load	202
0x004	WDTVALUE	RO	0xFFFF.FFFF	Watchdog Value	203
0x008	WDTCTL	R/W	0x0000.0000	Watchdog Control	204
0x00C	WDTICR	WO	-	Watchdog Interrupt Clear	205
0x010	WDTRIS	RO	0x0000.0000	Watchdog Raw Interrupt Status	206
0x014	WDTMIS	RO	0x0000.0000	Watchdog Masked Interrupt Status	207
0x418	WDTTEST	R/W	0x0000.0000	Watchdog Test	208
0xC00	WDTLOCK	R/W	0x0000.0000	Watchdog Lock	209

Offset	Name	Type	Reset	Description	See page
0xFD0	WDTPeriphID4	RO	0x0000.0000	Watchdog Peripheral Identification 4	210
0xFD4	WDTPeriphID5	RO	0x0000.0000	Watchdog Peripheral Identification 5	211
0xFD8	WDTPeriphID6	RO	0x0000.0000	Watchdog Peripheral Identification 6	212
0xFDC	WDTPeriphID7	RO	0x0000.0000	Watchdog Peripheral Identification 7	213
0xFE0	WDTPeriphID0	RO	0x0000.0005	Watchdog Peripheral Identification 0	214
0xFE4	WDTPeriphID1	RO	0x0000.0018	Watchdog Peripheral Identification 1	215
0xFE8	WDTPeriphID2	RO	0x0000.0018	Watchdog Peripheral Identification 2	216
0xFEC	WDTPeriphID3	RO	0x0000.0001	Watchdog Peripheral Identification 3	217
0xFF0	WDTPCellID0	RO	0x0000.000D	Watchdog PrimeCell Identification 0	218
0xFF4	WDTPCellID1	RO	0x0000.00F0	Watchdog PrimeCell Identification 1	219
0xFF8	WDTPCellID2	RO	0x0000.0005	Watchdog PrimeCell Identification 2	220
0xFFC	WDTPCellID3	RO	0x0000.00B1	Watchdog PrimeCell Identification 3	221

10.5 Register Descriptions

The remainder of this section lists and describes the WDT registers, in numerical order by address offset.

Register 1: Watchdog Load (WDTLOAD), offset 0x000

This register is the 32-bit interval value used by the 32-bit counter. When this register is written, the value is immediately loaded and the counter restarts counting down from the new value. If the **WDTLOAD** register is loaded with 0x0000.0000, an interrupt is immediately generated.

Watchdog Load (WDTLOAD)

Base 0x4000.0000
 Offset 0x000
 Type R/W, reset 0xFFFF.FFFF

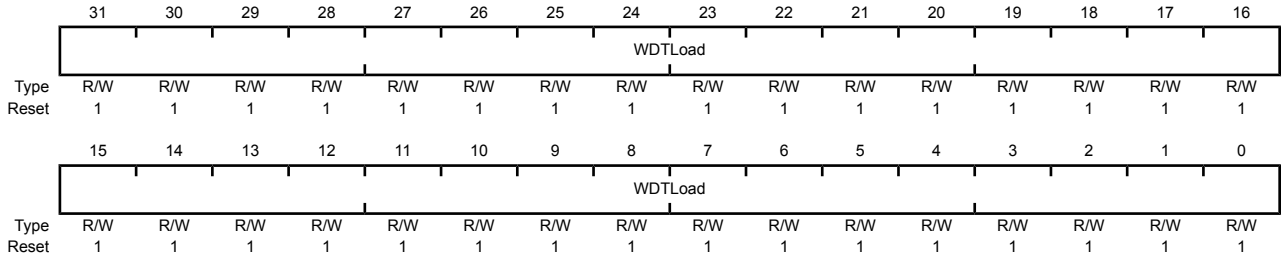

Bit/Field	Name	Type	Reset	Description
31:0	WDTLoad	R/W	0xFFFF.FFFF	Watchdog Load Value

Register 2: Watchdog Value (WDTVALUE), offset 0x004

This register contains the current count value of the timer.

Watchdog Value (WDTVALUE)

Base 0x4000.0000

Offset 0x004

Type RO, reset 0xFFFF.FFFF

	31	30	29	28	27	26	25	24	23	22	21	20	19	18	17	16
	WDTValue															
Type	RO	RO	RO	RO	RO	RO	RO	RO	RO	RO	RO	RO	RO	RO	RO	RO
Reset	1	1	1	1	1	1	1	1	1	1	1	1	1	1	1	1
	15	14	13	12	11	10	9	8	7	6	5	4	3	2	1	0
	WDTValue															
Type	RO	RO	RO	RO	RO	RO	RO	RO	RO	RO	RO	RO	RO	RO	RO	RO
Reset	1	1	1	1	1	1	1	1	1	1	1	1	1	1	1	1

Bit/Field	Name	Type	Reset	Description
31:0	WDTValue	RO	0xFFFF.FFFF	Watchdog Value Current value of the 32-bit down counter.

Register 3: Watchdog Control (WDTCTL), offset 0x008

This register is the watchdog control register. The watchdog timer can be configured to generate a reset signal (on second time-out) or an interrupt on time-out.

When the watchdog interrupt has been enabled, all subsequent writes to the control register are ignored. The only mechanism that can re-enable writes is a hardware reset.

Watchdog Control (WDTCTL)

Base 0x4000.0000
 Offset 0x008
 Type R/W, reset 0x0000.0000

	31	30	29	28	27	26	25	24	23	22	21	20	19	18	17	16	
	reserved																
Type	RO	RO	RO	RO	RO	RO	RO	RO	RO	RO	RO	RO	RO	RO	RO	RO	
Reset	0	0	0	0	0	0	0	0	0	0	0	0	0	0	0	0	
	15	14	13	12	11	10	9	8	7	6	5	4	3	2	1	0	
	reserved															RESEN	INTEN
Type	RO	RO	RO	RO	RO	RO	RO	RO	RO	RO	RO	RO	RO	RO	RO	R/W	R/W
Reset	0	0	0	0	0	0	0	0	0	0	0	0	0	0	0	0	0

Bit/Field	Name	Type	Reset	Description						
31:2	reserved	RO	0x00	Software should not rely on the value of a reserved bit. To provide compatibility with future products, the value of a reserved bit should be preserved across a read-modify-write operation.						
1	RESEN	R/W	0	Watchdog Reset Enable The RESEN values are defined as follows: <table border="1"> <thead> <tr> <th>Value</th> <th>Description</th> </tr> </thead> <tbody> <tr> <td>0</td> <td>Disabled.</td> </tr> <tr> <td>1</td> <td>Enable the Watchdog module reset output.</td> </tr> </tbody> </table>	Value	Description	0	Disabled.	1	Enable the Watchdog module reset output.
Value	Description									
0	Disabled.									
1	Enable the Watchdog module reset output.									
0	INTEN	R/W	0	Watchdog Interrupt Enable The INTEN values are defined as follows: <table border="1"> <thead> <tr> <th>Value</th> <th>Description</th> </tr> </thead> <tbody> <tr> <td>0</td> <td>Interrupt event disabled (once this bit is set, it can only be cleared by a hardware reset).</td> </tr> <tr> <td>1</td> <td>Interrupt event enabled. Once enabled, all writes are ignored.</td> </tr> </tbody> </table>	Value	Description	0	Interrupt event disabled (once this bit is set, it can only be cleared by a hardware reset).	1	Interrupt event enabled. Once enabled, all writes are ignored.
Value	Description									
0	Interrupt event disabled (once this bit is set, it can only be cleared by a hardware reset).									
1	Interrupt event enabled. Once enabled, all writes are ignored.									

Register 4: Watchdog Interrupt Clear (WDTICR), offset 0x00C

This register is the interrupt clear register. A write of any value to this register clears the Watchdog interrupt and reloads the 32-bit counter from the **WDTLOAD** register. Value for a read or reset is indeterminate.

Watchdog Interrupt Clear (WDTICR)

Base 0x4000.0000

Offset 0x00C

Type WO, reset -

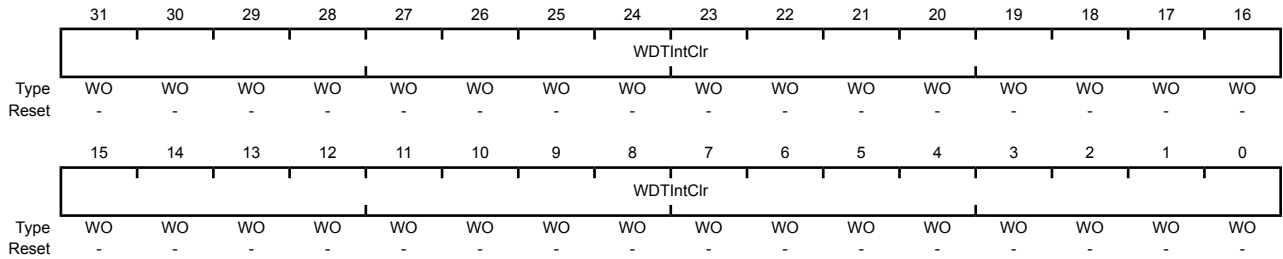

Bit/Field	Name	Type	Reset	Description
31:0	WDTIntClr	WO	-	Watchdog Interrupt Clear

Register 5: Watchdog Raw Interrupt Status (WDTRIS), offset 0x010

This register is the raw interrupt status register. Watchdog interrupt events can be monitored via this register if the controller interrupt is masked.

Watchdog Raw Interrupt Status (WDTRIS)

Base 0x4000.0000
 Offset 0x010
 Type RO, reset 0x0000.0000

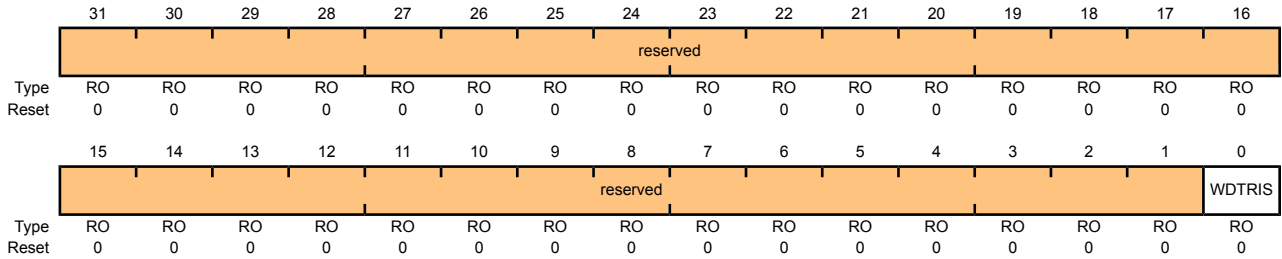

Bit/Field	Name	Type	Reset	Description
31:1	reserved	RO	0x00	Software should not rely on the value of a reserved bit. To provide compatibility with future products, the value of a reserved bit should be preserved across a read-modify-write operation.
0	WDTRIS	RO	0	Watchdog Raw Interrupt Status Gives the raw interrupt state (prior to masking) of WDTINTR .

Register 6: Watchdog Masked Interrupt Status (WDTMIS), offset 0x014

This register is the masked interrupt status register. The value of this register is the logical AND of the raw interrupt bit and the Watchdog interrupt enable bit.

Watchdog Masked Interrupt Status (WDTMIS)

Base 0x4000.0000

Offset 0x014

Type RO, reset 0x0000.0000

	31	30	29	28	27	26	25	24	23	22	21	20	19	18	17	16
	reserved															
Type	RO	RO	RO	RO	RO	RO	RO	RO	RO	RO	RO	RO	RO	RO	RO	RO
Reset	0	0	0	0	0	0	0	0	0	0	0	0	0	0	0	0
	15	14	13	12	11	10	9	8	7	6	5	4	3	2	1	0
	reserved															
Type	RO	RO	RO	RO	RO	RO	RO	RO	RO	RO	RO	RO	RO	RO	RO	RO
Reset	0	0	0	0	0	0	0	0	0	0	0	0	0	0	0	0

Bit/Field	Name	Type	Reset	Description
31:1	reserved	RO	0x00	Software should not rely on the value of a reserved bit. To provide compatibility with future products, the value of a reserved bit should be preserved across a read-modify-write operation.
0	WDTMIS	RO	0	Watchdog Masked Interrupt Status Gives the masked interrupt state (after masking) of the WDTINTR interrupt.

Register 7: Watchdog Test (WDTTEST), offset 0x418

This register provides user-enabled stalling when the microcontroller asserts the CPU halt flag during debug.

Watchdog Test (WDTTEST)

Base 0x4000.0000
 Offset 0x418
 Type R/W, reset 0x0000.0000

	31	30	29	28	27	26	25	24	23	22	21	20	19	18	17	16
	reserved															
Type	RO	RO	RO	RO	RO	RO	RO	RO	RO	RO	RO	RO	RO	RO	RO	RO
Reset	0	0	0	0	0	0	0	0	0	0	0	0	0	0	0	0
	15	14	13	12	11	10	9	8	7	6	5	4	3	2	1	0
	reserved							STALL	reserved							
Type	RO	RO	RO	RO	RO	RO	RO	R/W	RO	RO	RO	RO	RO	RO	RO	RO
Reset	0	0	0	0	0	0	0	0	0	0	0	0	0	0	0	0

Bit/Field	Name	Type	Reset	Description
31:9	reserved	RO	0x00	Software should not rely on the value of a reserved bit. To provide compatibility with future products, the value of a reserved bit should be preserved across a read-modify-write operation.
8	STALL	R/W	0	Watchdog Stall Enable When set to 1, if the Stellaris® microcontroller is stopped with a debugger, the watchdog timer stops counting. Once the microcontroller is restarted, the watchdog timer resumes counting.
7:0	reserved	RO	0x00	Software should not rely on the value of a reserved bit. To provide compatibility with future products, the value of a reserved bit should be preserved across a read-modify-write operation.

Register 8: Watchdog Lock (WDTLOCK), offset 0xC00

Writing 0x1ACC.E551 to the **WDTLOCK** register enables write access to all other registers. Writing any other value to the **WDTLOCK** register re-enables the locked state for register writes to all the other registers. Reading the **WDTLOCK** register returns the lock status rather than the 32-bit value written. Therefore, when write accesses are disabled, reading the **WDTLOCK** register returns 0x0000.0001 (when locked; otherwise, the returned value is 0x0000.0000 (unlocked)).

Watchdog Lock (WDTLOCK)

Base 0x4000.0000
 Offset 0xC00
 Type R/W, reset 0x0000.0000

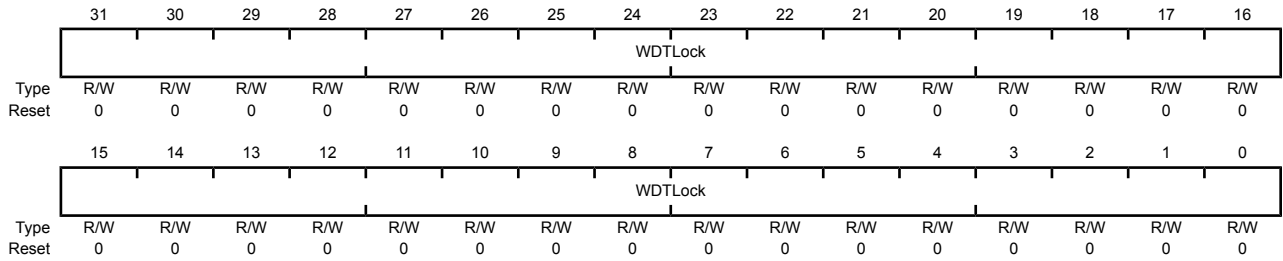

Bit/Field	Name	Type	Reset	Description
-----------	------	------	-------	-------------

31:0	WDTLock	R/W	0x0000	Watchdog Lock
------	---------	-----	--------	---------------

A write of the value 0x1ACC.E551 unlocks the watchdog registers for write access. A write of any other value reapplies the lock, preventing any register updates.

A read of this register returns the following values:

Value	Description
0x0000.0001	Locked
0x0000.0000	Unlocked

Register 9: Watchdog Peripheral Identification 4 (WDTPeriphID4), offset 0xFD0

The **WDTPeriphIDn** registers are hard-coded and the fields within the register determine the reset value.

Watchdog Peripheral Identification 4 (WDTPeriphID4)

Base 0x4000.0000
 Offset 0xFD0
 Type RO, reset 0x0000.0000

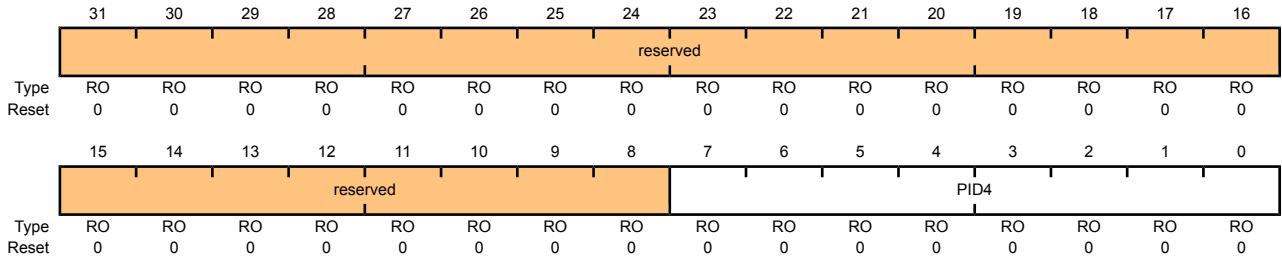

Bit/Field	Name	Type	Reset	Description
31:8	reserved	RO	0x00	Software should not rely on the value of a reserved bit. To provide compatibility with future products, the value of a reserved bit should be preserved across a read-modify-write operation.
7:0	PID4	RO	0x00	WDT Peripheral ID Register[7:0]

Register 10: Watchdog Peripheral Identification 5 (WDTPeriphID5), offset 0xFD4

The **WDTPeriphIDn** registers are hard-coded and the fields within the register determine the reset value.

Watchdog Peripheral Identification 5 (WDTPeriphID5)

Base 0x4000.0000

Offset 0xFD4

Type RO, reset 0x0000.0000

	31	30	29	28	27	26	25	24	23	22	21	20	19	18	17	16
	reserved															
Type	RO	RO	RO	RO	RO	RO	RO	RO	RO	RO	RO	RO	RO	RO	RO	RO
Reset	0	0	0	0	0	0	0	0	0	0	0	0	0	0	0	0
	15	14	13	12	11	10	9	8	7	6	5	4	3	2	1	0
	reserved								PID5							
Type	RO	RO	RO	RO	RO	RO	RO	RO	RO	RO	RO	RO	RO	RO	RO	RO
Reset	0	0	0	0	0	0	0	0	0	0	0	0	0	0	0	0

Bit/Field	Name	Type	Reset	Description
31:8	reserved	RO	0x00	Software should not rely on the value of a reserved bit. To provide compatibility with future products, the value of a reserved bit should be preserved across a read-modify-write operation.
7:0	PID5	RO	0x00	WDT Peripheral ID Register[15:8]

Register 11: Watchdog Peripheral Identification 6 (WDTPeriphID6), offset 0xFD8

The **WDTPeriphIDn** registers are hard-coded and the fields within the register determine the reset value.

Watchdog Peripheral Identification 6 (WDTPeriphID6)

Base 0x4000.0000
 Offset 0xFD8
 Type RO, reset 0x0000.0000

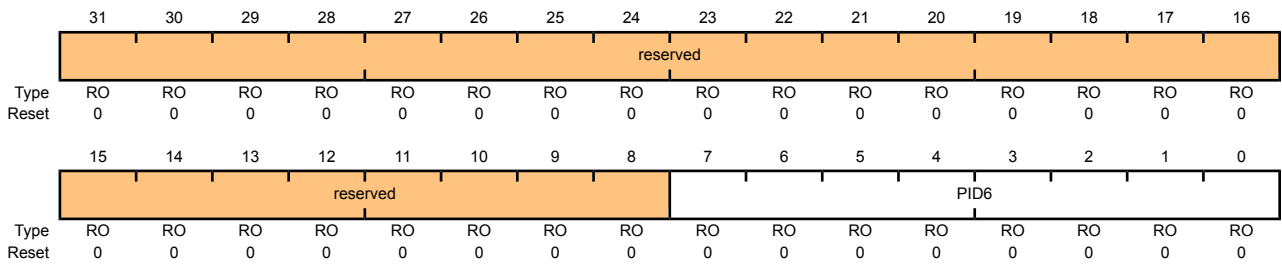

Bit/Field	Name	Type	Reset	Description
31:8	reserved	RO	0x00	Software should not rely on the value of a reserved bit. To provide compatibility with future products, the value of a reserved bit should be preserved across a read-modify-write operation.
7:0	PID6	RO	0x00	WDT Peripheral ID Register[23:16]

Register 12: Watchdog Peripheral Identification 7 (WDTPeriphID7), offset 0xFDC

The **WDTPeriphIDn** registers are hard-coded and the fields within the register determine the reset value.

Watchdog Peripheral Identification 7 (WDTPeriphID7)

Base 0x4000.0000

Offset 0xFDC

Type RO, reset 0x0000.0000

	31	30	29	28	27	26	25	24	23	22	21	20	19	18	17	16
	reserved															
Type	RO	RO	RO	RO	RO	RO	RO	RO	RO	RO	RO	RO	RO	RO	RO	RO
Reset	0	0	0	0	0	0	0	0	0	0	0	0	0	0	0	0
	15	14	13	12	11	10	9	8	7	6	5	4	3	2	1	0
	reserved								PID7							
Type	RO	RO	RO	RO	RO	RO	RO	RO	RO	RO	RO	RO	RO	RO	RO	RO
Reset	0	0	0	0	0	0	0	0	0	0	0	0	0	0	0	0

Bit/Field	Name	Type	Reset	Description
31:8	reserved	RO	0x00	Software should not rely on the value of a reserved bit. To provide compatibility with future products, the value of a reserved bit should be preserved across a read-modify-write operation.
7:0	PID7	RO	0x00	WDT Peripheral ID Register[31:24]

Register 13: Watchdog Peripheral Identification 0 (WDTPeriphID0), offset 0xFE0

The **WDTPeriphIDn** registers are hard-coded and the fields within the register determine the reset value.

Watchdog Peripheral Identification 0 (WDTPeriphID0)

Base 0x4000.0000
 Offset 0xFE0
 Type RO, reset 0x0000.0005

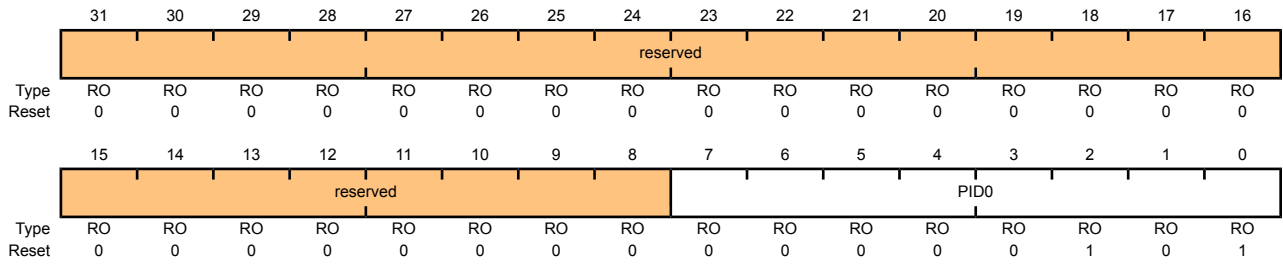

Bit/Field	Name	Type	Reset	Description
31:8	reserved	RO	0x00	Software should not rely on the value of a reserved bit. To provide compatibility with future products, the value of a reserved bit should be preserved across a read-modify-write operation.
7:0	PID0	RO	0x05	Watchdog Peripheral ID Register[7:0]

Register 14: Watchdog Peripheral Identification 1 (WDTPeriphID1), offset 0xFE4

The **WDTPeriphIDn** registers are hard-coded and the fields within the register determine the reset value.

Watchdog Peripheral Identification 1 (WDTPeriphID1)

Base 0x4000.0000

Offset 0xFE4

Type RO, reset 0x0000.0018

	31	30	29	28	27	26	25	24	23	22	21	20	19	18	17	16
	reserved															
Type	RO	RO	RO	RO	RO	RO	RO	RO	RO	RO	RO	RO	RO	RO	RO	RO
Reset	0	0	0	0	0	0	0	0	0	0	0	0	0	0	0	0
	15	14	13	12	11	10	9	8	7	6	5	4	3	2	1	0
	reserved								PID1							
Type	RO	RO	RO	RO	RO	RO	RO	RO	RO	RO	RO	RO	RO	RO	RO	RO
Reset	0	0	0	0	0	0	0	0	0	0	0	1	1	0	0	0

Bit/Field	Name	Type	Reset	Description
31:8	reserved	RO	0x00	Software should not rely on the value of a reserved bit. To provide compatibility with future products, the value of a reserved bit should be preserved across a read-modify-write operation.
7:0	PID1	RO	0x18	Watchdog Peripheral ID Register[15:8]

Register 15: Watchdog Peripheral Identification 2 (WDTPeriphID2), offset 0xFE8

The **WDTPeriphIDn** registers are hard-coded and the fields within the register determine the reset value.

Watchdog Peripheral Identification 2 (WDTPeriphID2)

Base 0x4000.0000
 Offset 0xFE8
 Type RO, reset 0x0000.0018

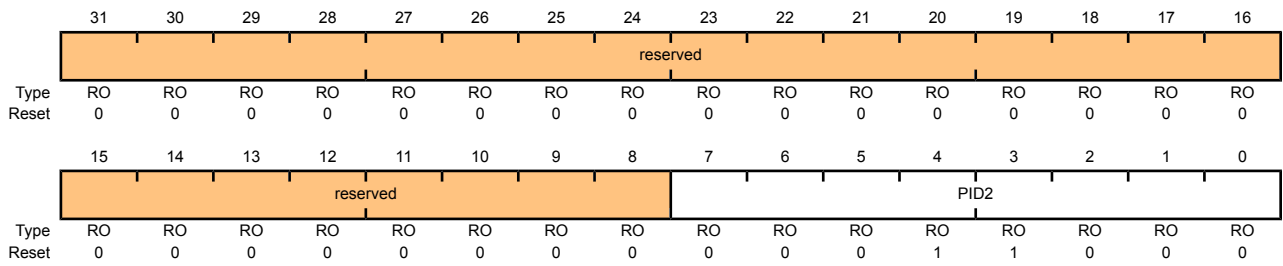

Bit/Field	Name	Type	Reset	Description
31:8	reserved	RO	0x00	Software should not rely on the value of a reserved bit. To provide compatibility with future products, the value of a reserved bit should be preserved across a read-modify-write operation.
7:0	PID2	RO	0x18	Watchdog Peripheral ID Register[23:16]

Register 16: Watchdog Peripheral Identification 3 (WDTPeriphID3), offset 0xFEC

The **WDTPeriphIDn** registers are hard-coded and the fields within the register determine the reset value.

Watchdog Peripheral Identification 3 (WDTPeriphID3)

Base 0x4000.0000

Offset 0xFEC

Type RO, reset 0x0000.0001

	31	30	29	28	27	26	25	24	23	22	21	20	19	18	17	16
	reserved															
Type	RO	RO	RO	RO	RO	RO	RO	RO	RO	RO	RO	RO	RO	RO	RO	RO
Reset	0	0	0	0	0	0	0	0	0	0	0	0	0	0	0	0
	15	14	13	12	11	10	9	8	7	6	5	4	3	2	1	0
	reserved								PID3							
Type	RO	RO	RO	RO	RO	RO	RO	RO	RO	RO	RO	RO	RO	RO	RO	RO
Reset	0	0	0	0	0	0	0	0	0	0	0	0	0	0	0	1

Bit/Field	Name	Type	Reset	Description
31:8	reserved	RO	0x00	Software should not rely on the value of a reserved bit. To provide compatibility with future products, the value of a reserved bit should be preserved across a read-modify-write operation.
7:0	PID3	RO	0x01	Watchdog Peripheral ID Register[31:24]

Register 17: Watchdog PrimeCell Identification 0 (WDTPCellID0), offset 0xFF0

The **WDTPCellIDn** registers are hard-coded and the fields within the register determine the reset value.

Watchdog PrimeCell Identification 0 (WDTPCellID0)

Base 0x4000.0000
 Offset 0xFF0
 Type RO, reset 0x0000.000D

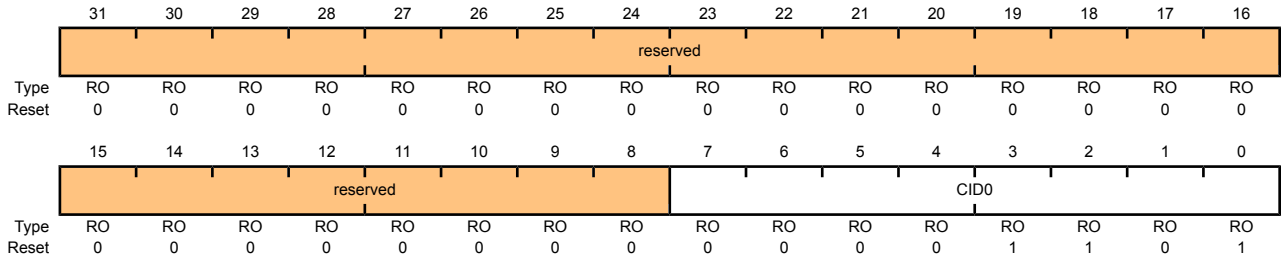

Bit/Field	Name	Type	Reset	Description
31:8	reserved	RO	0x00	Software should not rely on the value of a reserved bit. To provide compatibility with future products, the value of a reserved bit should be preserved across a read-modify-write operation.
7:0	CID0	RO	0x0D	Watchdog PrimeCell ID Register[7:0]

Register 18: Watchdog PrimeCell Identification 1 (WDTPCellID1), offset 0xFF4

The **WDTPCellIDn** registers are hard-coded and the fields within the register determine the reset value.

Watchdog PrimeCell Identification 1 (WDTPCellID1)

Base 0x4000.0000

Offset 0xFF4

Type RO, reset 0x0000.00F0

	31	30	29	28	27	26	25	24	23	22	21	20	19	18	17	16
	reserved															
Type	RO	RO	RO	RO	RO	RO	RO	RO	RO	RO	RO	RO	RO	RO	RO	RO
Reset	0	0	0	0	0	0	0	0	0	0	0	0	0	0	0	0
	15	14	13	12	11	10	9	8	7	6	5	4	3	2	1	0
	reserved								CID1							
Type	RO	RO	RO	RO	RO	RO	RO	RO	RO	RO	RO	RO	RO	RO	RO	RO
Reset	0	0	0	0	0	0	0	0	1	1	1	1	0	0	0	0

Bit/Field	Name	Type	Reset	Description
31:8	reserved	RO	0x00	Software should not rely on the value of a reserved bit. To provide compatibility with future products, the value of a reserved bit should be preserved across a read-modify-write operation.
7:0	CID1	RO	0xF0	Watchdog PrimeCell ID Register[15:8]

Register 19: Watchdog PrimeCell Identification 2 (WDTPCellID2), offset 0xFF8

The **WDTPCellIDn** registers are hard-coded and the fields within the register determine the reset value.

Watchdog PrimeCell Identification 2 (WDTPCellID2)

Base 0x4000.0000
 Offset 0xFF8
 Type RO, reset 0x0000.0005

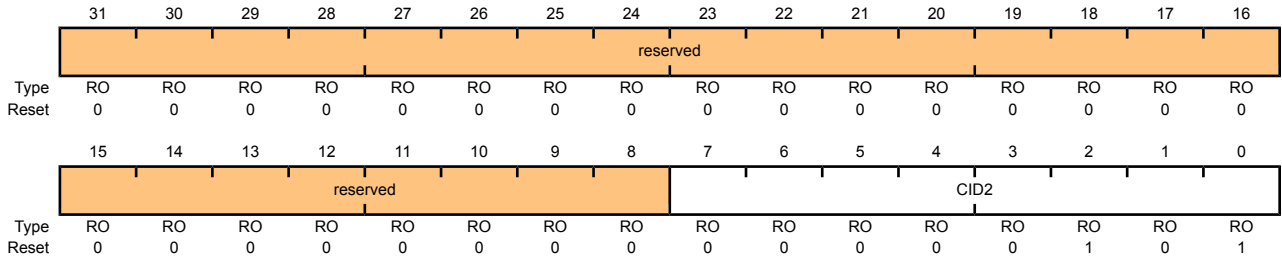

Bit/Field	Name	Type	Reset	Description
31:8	reserved	RO	0x00	Software should not rely on the value of a reserved bit. To provide compatibility with future products, the value of a reserved bit should be preserved across a read-modify-write operation.
7:0	CID2	RO	0x05	Watchdog PrimeCell ID Register[23:16]

Register 20: Watchdog PrimeCell Identification 3 (WDTPCellID3), offset 0xFFC

The **WDTPCellIDn** registers are hard-coded and the fields within the register determine the reset value.

Watchdog PrimeCell Identification 3 (WDTPCellID3)

Base 0x4000.0000

Offset 0xFFC

Type RO, reset 0x0000.00B1

	31	30	29	28	27	26	25	24	23	22	21	20	19	18	17	16
	reserved															
Type	RO	RO	RO	RO	RO	RO	RO	RO	RO	RO	RO	RO	RO	RO	RO	RO
Reset	0	0	0	0	0	0	0	0	0	0	0	0	0	0	0	0
	15	14	13	12	11	10	9	8	7	6	5	4	3	2	1	0
	reserved								CID3							
Type	RO	RO	RO	RO	RO	RO	RO	RO	RO	RO	RO	RO	RO	RO	RO	RO
Reset	0	0	0	0	0	0	0	0	1	0	1	1	0	0	0	1

Bit/Field	Name	Type	Reset	Description
31:8	reserved	RO	0x00	Software should not rely on the value of a reserved bit. To provide compatibility with future products, the value of a reserved bit should be preserved across a read-modify-write operation.
7:0	CID3	RO	0xB1	Watchdog PrimeCell ID Register[31:24]

11 Analog-to-Digital Converter (ADC)

An analog-to-digital converter (ADC) is a peripheral that converts a continuous analog voltage to a discrete digital number.

The Stellaris[®] ADC module features 10-bit conversion resolution and supports eight input channels, plus an internal temperature sensor. The ADC module contains a programmable sequencer which allows for the sampling of multiple analog input sources without controller intervention. Each sample sequence provides flexible programming with fully configurable input source, trigger events, interrupt generation, and sequence priority.

The Stellaris[®] ADC provides the following features:

- Eight analog input channels
- Single-ended and differential-input configurations
- Internal temperature sensor
- Sample rate of one million samples/second
- Four programmable sample conversion sequences from one to eight entries long, with corresponding conversion result FIFOs
- Flexible trigger control
 - Controller (software)
 - Timers
 - GPIO
- Hardware averaging of up to 64 samples for improved accuracy
- An internal 3-V reference is used by the converter.

11.1 Block Diagram

Figure 11-1. ADC Module Block Diagram

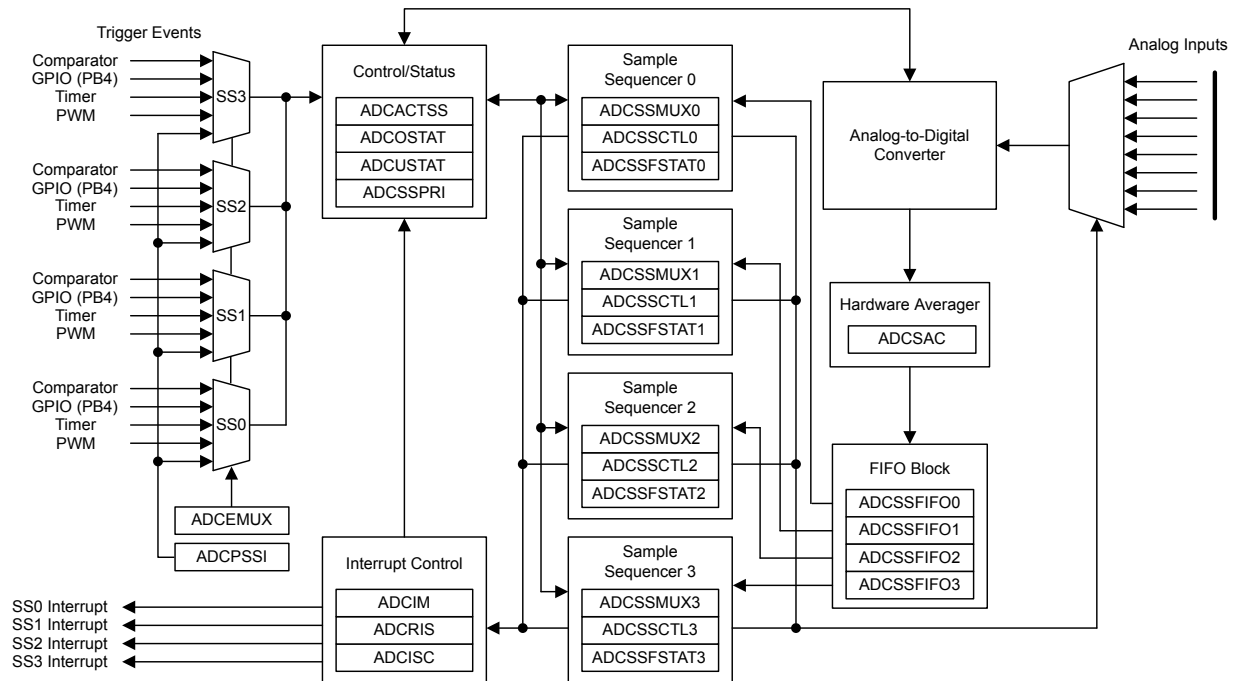

11.2 Functional Description

The Stellaris[®] ADC collects sample data by using a programmable sequence-based approach instead of the traditional single or double-sampling approach found on many ADC modules. Each *sample sequence* is a fully programmed series of consecutive (back-to-back) samples, allowing the ADC to collect data from multiple input sources without having to be re-configured or serviced by the controller. The programming of each sample in the sample sequence includes parameters such as the input source and mode (differential versus single-ended input), interrupt generation on sample completion, and the indicator for the last sample in the sequence.

11.2.1 Sample Sequencers

The sampling control and data capture is handled by the Sample Sequencers. All of the sequencers are identical in implementation except for the number of samples that can be captured and the depth of the FIFO. Table 11-1 on page 223 shows the maximum number of samples that each Sequencer can capture and its corresponding FIFO depth. In this implementation, each FIFO entry is a 32-bit word, with the lower 10 bits containing the conversion result.

Table 11-1. Samples and FIFO Depth of Sequencers

Sequencer	Number of Samples	Depth of FIFO
SS3	1	1
SS2	4	4
SS1	4	4
SS0	8	8

For a given sample sequence, each sample is defined by two 4-bit nibbles in the **ADC Sample Sequence Input Multiplexer Select (ADCSSMUXn)** and **ADC Sample Sequence Control (ADCSSCTLn)** registers, where "n" corresponds to the sequence number. The **ADCSSMUXn** nibbles select the input pin, while the **ADCSSCTLn** nibbles contain the sample control bits corresponding to parameters such as temperature sensor selection, interrupt enable, end of sequence, and differential input mode. Sample Sequencers are enabled by setting the respective **ASENn** bit in the **ADC Active Sample Sequencer (ADCACTSS)** register, but can be configured before being enabled.

When configuring a sample sequence, multiple uses of the same input pin within the same sequence is allowed. In the **ADCSSCTLn** register, the **Interrupt Enable (IE)** bits can be set for any combination of samples, allowing interrupts to be generated after every sample in the sequence if necessary. Also, the **END** bit can be set at any point within a sample sequence. For example, if Sequencer 0 is used, the **END** bit can be set in the nibble associated with the fifth sample, allowing Sequencer 0 to complete execution of the sample sequence after the fifth sample.

After a sample sequence completes execution, the result data can be retrieved from the **ADC Sample Sequence Result FIFO (ADCSSFIFO)** registers. The FIFOs are simple circular buffers that read a single address to "pop" result data. For software debug purposes, the positions of the FIFO head and tail pointers are visible in the **ADC Sample Sequence FIFO Status (ADCSSFSTATn)** registers along with **FULL** and **EMPTY** status flags. Overflow and underflow conditions are monitored using the **ADCSTAT** and **ADCUSTAT** registers.

11.2.2 Module Control

Outside of the Sample Sequencers, the remainder of the control logic is responsible for tasks such as interrupt generation, sequence prioritization, and trigger configuration.

Most of the ADC control logic runs at the ADC clock rate of 14-18 MHz. The internal ADC divider is configured automatically by hardware when the system **XTAL** is selected. The automatic clock divider configuration targets 16.667 MHz operation for all Stellaris[®] devices.

11.2.2.1 Interrupts

The Sample Sequencers dictate the events that cause interrupts, but they don't have control over whether the interrupt is actually sent to the interrupt controller. The ADC module's interrupt signal is controlled by the state of the **MASK** bits in the **ADC Interrupt Mask (ADCIM)** register. Interrupt status can be viewed at two locations: the **ADC Raw Interrupt Status (ADCRIS)** register, which shows the raw status of a Sample Sequencer's interrupt signal, and the **ADC Interrupt Status and Clear (ADCISC)** register, which shows the logical AND of the **ADCRIS** register's **INR** bit and the **ADCIM** register's **MASK** bits. Interrupts are cleared by writing a 1 to the corresponding **IN** bit in **ADCISC**.

11.2.2.2 Prioritization

When sampling events (triggers) happen concurrently, they are prioritized for processing by the values in the **ADC Sample Sequencer Priority (ADCSSPRI)** register. Valid priority values are in the range of 0-3, with 0 being the highest priority and 3 being the lowest. Multiple active Sample Sequencer units with the same priority do not provide consistent results, so software must ensure that all active Sample Sequencer units have a unique priority value.

11.2.2.3 Sampling Events

Sample triggering for each Sample Sequencer is defined in the **ADC Event Multiplexer Select (ADCEMUX)** register. The external peripheral triggering sources vary by Stellaris[®] family member,

but all devices share the "Controller" and "Always" triggers. Software can initiate sampling by setting the `CH` bits in the **ADC Processor Sample Sequence Initiate (ADCPSSI)** register.

When using the "Always" trigger, care must be taken. If a sequence's priority is too high, it is possible to starve other lower priority sequences.

11.2.3 Hardware Sample Averaging Circuit

Higher precision results can be generated using the hardware averaging circuit, however, the improved results are at the cost of throughput. Up to 64 samples can be accumulated and averaged to form a single data entry in the sequencer FIFO. Throughput is decreased proportionally to the number of samples in the averaging calculation. For example, if the averaging circuit is configured to average 16 samples, the throughput is decreased by a factor of 16.

By default the averaging circuit is off and all data from the converter passes through to the sequencer FIFO. The averaging hardware is controlled by the **ADC Sample Averaging Control (ADCSAC)** register (see page 241). There is a single averaging circuit and all input channels receive the same amount of averaging whether they are single-ended or differential.

11.2.4 Analog-to-Digital Converter

The converter itself generates a 10-bit output value for selected analog input. Special analog pads are used to minimize the distortion on the input. An internal 3 V reference is used by the converter resulting in sample values ranging from 0x000 at 0 V input to 0x3FF at 3 V input when in single-ended input mode.

11.2.5 Differential Sampling

In addition to traditional single-ended sampling, the ADC module supports differential sampling of two analog input channels. To enable differential sampling, software must set the `D` bit (in the **ADCSSCTL0** register) in a step's configuration nibble.

When a sequence step is configured for differential sampling, its corresponding value in the **ADCSSMUX** register must be set to one of the four differential pairs, numbered 0-3. Differential pair 0 samples analog inputs 0 and 1; differential pair 1 samples analog inputs 2 and 3; and so on (see Table 11-2 on page 225). The ADC does not support other differential pairings such as analog input 0 with analog input 3. The number of differential pairs supported is dependent on the number of analog inputs (see Table 11-2 on page 225).

Table 11-2. Differential Sampling Pairs

Differential Pair	Analog Inputs
0	0 and 1
1	2 and 3
2	4 and 5
3	6 and 7

The voltage sampled in differential mode is the difference between the odd and even channels:

ΔV (differential voltage) = V_{IN_EVEN} (even channels) – V_{IN_ODD} (odd channels), therefore:

- If $\Delta V = 0$, then the conversion result = 0x1FF
- If $\Delta V > 0$, then the conversion result > 0x1FF (range is 0x1FF–0x3FF)
- If $\Delta V < 0$, then the conversion result < 0x1FF (range is 0–0x1FF)

The differential pairs assign polarities to the analog inputs: the even-numbered input is always positive, and the odd-numbered input is always negative. In order for a valid conversion result to appear, the negative input must be in the range of ± 1.5 V of the positive input. If an analog input is greater than 3 V or less than 0 V (the valid range for analog inputs), the input voltage is clipped, meaning it appears as either 3 V or 0 V, respectively, to the ADC.

Figure 11-2 on page 226 shows an example of the negative input centered at 1.5 V. In this configuration, the differential range spans from -1.5 V to 1.5 V. Figure 11-3 on page 226 shows an example where the negative input is centered at -0.75 V, meaning inputs on the positive input saturate past a differential voltage of -0.75 V since the input voltage is less than 0 V. Figure 11-4 on page 227 shows an example of the negative input centered at 2.25 V, where inputs on the positive channel saturate past a differential voltage of 0.75 V since the input voltage would be greater than 3 V.

Figure 11-2. Differential Sampling Range, $V_{IN_ODD} = 1.5$ V

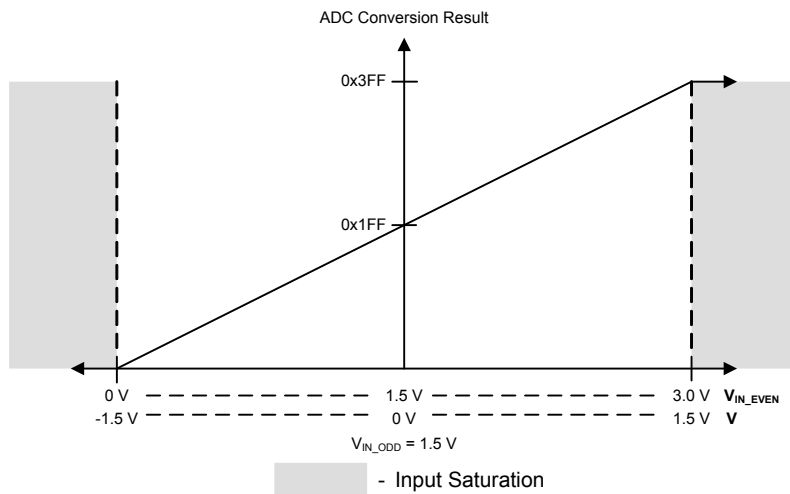

Figure 11-3. Differential Sampling Range, $V_{IN_ODD} = 0.75$ V

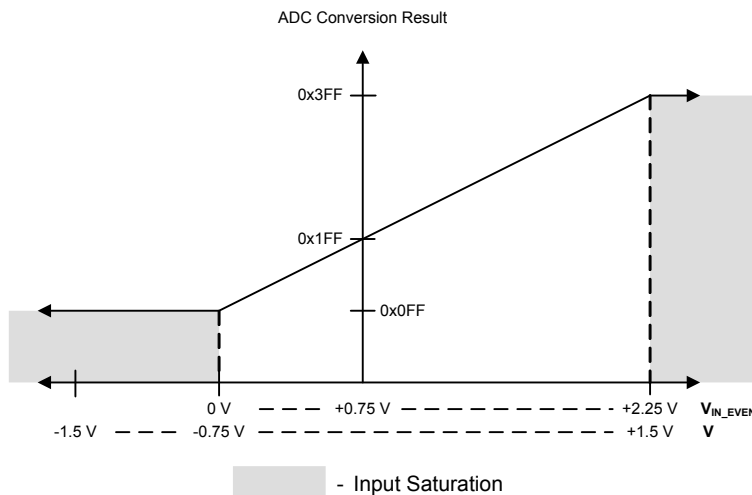
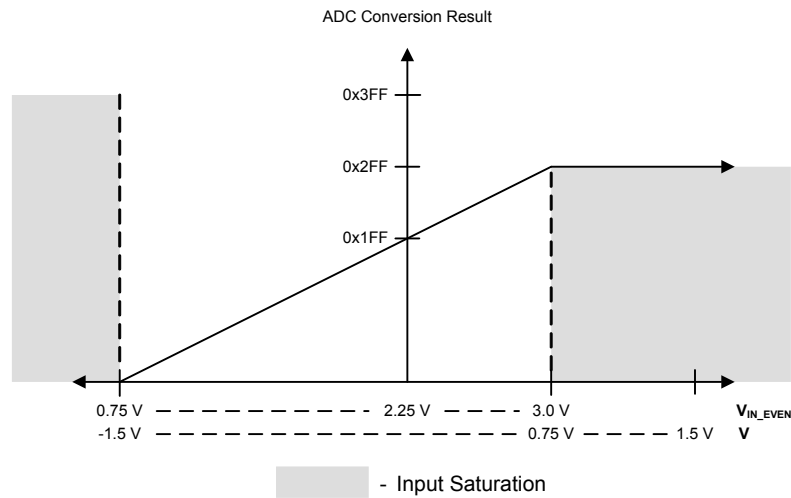

Figure 11-4. Differential Sampling Range, $V_{IN_ODD} = 2.25\text{ V}$



11.2.6 Test Modes

There is a user-available test mode that allows for loopback operation within the digital portion of the ADC module. This can be useful for debugging software without having to provide actual analog stimulus. This mode is available through the **ADC Test Mode Loopback (ADCTMLB)** register (see page 254).

11.2.7 Internal Temperature Sensor

The internal temperature sensor provides an analog temperature reading as well as a reference voltage. The voltage at the output terminal SENS0 is given by the following equation:

$$SENS0 = 2.7 - ((T + 55) / 75)$$

This relation is shown in Figure 11-5 on page 227.

Figure 11-5. Internal Temperature Sensor Characteristic

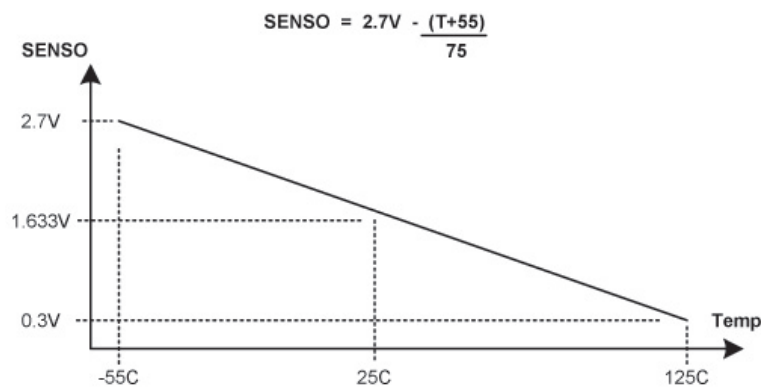

11.3 Initialization and Configuration

In order for the ADC module to be used, the PLL must be enabled and using a supported crystal frequency (see the **RCC** register). Using unsupported frequencies can cause faulty operation in the ADC module.

11.3.1 Module Initialization

Initialization of the ADC module is a simple process with very few steps. The main steps include enabling the clock to the ADC and reconfiguring the Sample Sequencer priorities (if needed).

The initialization sequence for the ADC is as follows:

1. Enable the ADC clock by writing a value of 0x0001.0000 to the **RCGC1** register (see page 93).
2. If required by the application, reconfigure the Sample Sequencer priorities in the **ADCSSPRI** register. The default configuration has Sample Sequencer 0 with the highest priority, and Sample Sequencer 3 as the lowest priority.

11.3.2 Sample Sequencer Configuration

Configuration of the Sample Sequencers is slightly more complex than the module initialization since each sample sequence is completely programmable.

The configuration for each Sample Sequencer should be as follows:

1. Ensure that the Sample Sequencer is disabled by writing a 0 to the corresponding **ASEN** bit in the **ADCACTSS** register. Programming of the Sample Sequencers is allowed without having them enabled. Disabling the Sequencer during programming prevents erroneous execution if a trigger event were to occur during the configuration process.
2. Configure the trigger event for the Sample Sequencer in the **ADCEMUX** register.
3. For each sample in the sample sequence, configure the corresponding input source in the **ADCSSMUXn** register.
4. For each sample in the sample sequence, configure the sample control bits in the corresponding nibble in the **ADCSSCTLn** register. When programming the last nibble, ensure that the **END** bit is set. Failure to set the **END** bit causes unpredictable behavior.
5. If interrupts are to be used, write a 1 to the corresponding **MASK** bit in the **ADCIM** register.
6. Enable the Sample Sequencer logic by writing a 1 to the corresponding **ASEN** bit in the **ADCACTSS** register.

11.4 Register Map

Table 11-3 on page 228 lists the ADC registers. The offset listed is a hexadecimal increment to the register's address, relative to the ADC base address of 0x4003.8000.

Table 11-3. ADC Register Map

Offset	Name	Type	Reset	Description	See page
0x000	ADCACTSS	R/W	0x0000.0000	ADC Active Sample Sequencer	230

Offset	Name	Type	Reset	Description	See page
0x004	ADCRIS	RO	0x0000.0000	ADC Raw Interrupt Status	231
0x008	ADCIM	R/W	0x0000.0000	ADC Interrupt Mask	232
0x00C	ADCISC	R/W1C	0x0000.0000	ADC Interrupt Status and Clear	233
0x010	ADCOSTAT	R/W1C	0x0000.0000	ADC Overflow Status	234
0x014	ADCEMUX	R/W	0x0000.0000	ADC Event Multiplexer Select	235
0x018	ADCUSTAT	R/W1C	0x0000.0000	ADC Underflow Status	238
0x020	ADCSSPRI	R/W	0x0000.3210	ADC Sample Sequencer Priority	239
0x028	ADCPSSI	WO	-	ADC Processor Sample Sequence Initiate	240
0x030	ADCSAC	R/W	0x0000.0000	ADC Sample Averaging Control	241
0x040	ADCSSMUX0	R/W	0x0000.0000	ADC Sample Sequence Input Multiplexer Select 0	242
0x044	ADCSSCTL0	R/W	0x0000.0000	ADC Sample Sequence Control 0	244
0x048	ADCSSFIFO0	RO	0x0000.0000	ADC Sample Sequence Result FIFO 0	247
0x04C	ADCSSFSTAT0	RO	0x0000.0100	ADC Sample Sequence FIFO 0 Status	248
0x060	ADCSSMUX1	R/W	0x0000.0000	ADC Sample Sequence Input Multiplexer Select 1	249
0x064	ADCSSCTL1	R/W	0x0000.0000	ADC Sample Sequence Control 1	250
0x068	ADCSSFIFO1	RO	0x0000.0000	ADC Sample Sequence Result FIFO 1	247
0x06C	ADCSSFSTAT1	RO	0x0000.0100	ADC Sample Sequence FIFO 1 Status	248
0x080	ADCSSMUX2	R/W	0x0000.0000	ADC Sample Sequence Input Multiplexer Select 2	249
0x084	ADCSSCTL2	R/W	0x0000.0000	ADC Sample Sequence Control 2	250
0x088	ADCSSFIFO2	RO	0x0000.0000	ADC Sample Sequence Result FIFO 2	247
0x08C	ADCSSFSTAT2	RO	0x0000.0100	ADC Sample Sequence FIFO 2 Status	248
0x0A0	ADCSSMUX3	R/W	0x0000.0000	ADC Sample Sequence Input Multiplexer Select 3	252
0x0A4	ADCSSCTL3	R/W	0x0000.0002	ADC Sample Sequence Control 3	253
0x0A8	ADCSSFIFO3	RO	0x0000.0000	ADC Sample Sequence Result FIFO 3	247
0x0AC	ADCSSFSTAT3	RO	0x0000.0100	ADC Sample Sequence FIFO 3 Status	248
0x100	ADCTMLB	R/W	0x0000.0000	ADC Test Mode Loopback	254

11.5 Register Descriptions

The remainder of this section lists and describes the ADC registers, in numerical order by address offset.

Register 1: ADC Active Sample Sequencer (ADCACTSS), offset 0x000

This register controls the activation of the Sample Sequencers. Each Sample Sequencer can be enabled/disabled independently.

ADC Active Sample Sequencer (ADCACTSS)

Base 0x4003.8000
 Offset 0x000
 Type R/W, reset 0x0000.0000

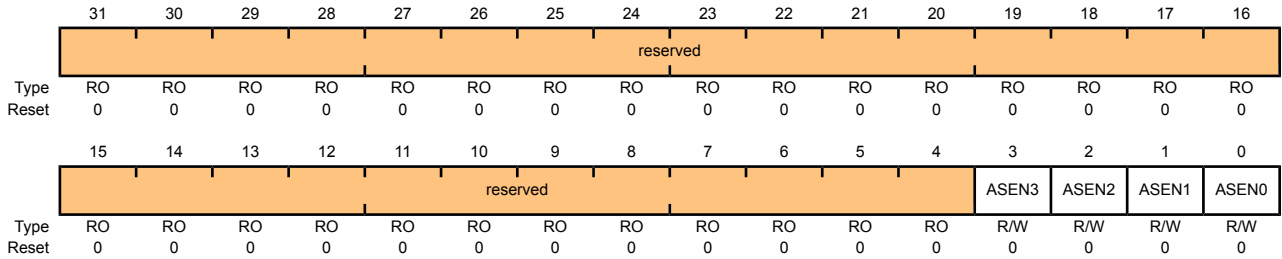

Bit/Field	Name	Type	Reset	Description
31:4	reserved	RO	0x00	Software should not rely on the value of a reserved bit. To provide compatibility with future products, the value of a reserved bit should be preserved across a read-modify-write operation.
3	ASEN3	R/W	0	ADC SS3 Enable Specifies whether Sample Sequencer 3 is enabled. If set, the sample sequence logic for Sequencer 3 is active. Otherwise, the Sequencer is inactive.
2	ASEN2	R/W	0	ADC SS2 Enable Specifies whether Sample Sequencer 2 is enabled. If set, the sample sequence logic for Sequencer 2 is active. Otherwise, the Sequencer is inactive.
1	ASEN1	R/W	0	ADC SS1 Enable Specifies whether Sample Sequencer 1 is enabled. If set, the sample sequence logic for Sequencer 1 is active. Otherwise, the Sequencer is inactive.
0	ASEN0	R/W	0	ADC SS0 Enable Specifies whether Sample Sequencer 0 is enabled. If set, the sample sequence logic for Sequencer 0 is active. Otherwise, the Sequencer is inactive.

Register 2: ADC Raw Interrupt Status (ADCRIS), offset 0x004

This register shows the status of the raw interrupt signal of each Sample Sequencer. These bits may be polled by software to look for interrupt conditions without having to generate controller interrupts.

ADC Raw Interrupt Status (ADCRIS)

Base 0x4003.8000
Offset 0x004
Type RO, reset 0x0000.0000

	31	30	29	28	27	26	25	24	23	22	21	20	19	18	17	16
	reserved															
Type	RO	RO	RO	RO	RO	RO	RO	RO	RO	RO	RO	RO	RO	RO	RO	RO
Reset	0	0	0	0	0	0	0	0	0	0	0	0	0	0	0	0
	15	14	13	12	11	10	9	8	7	6	5	4	3	2	1	0
	reserved												INR3	INR2	INR1	INR0
Type	RO	RO	RO	RO	RO	RO	RO	RO	RO	RO	RO	RO	RO	RO	RO	RO
Reset	0	0	0	0	0	0	0	0	0	0	0	0	0	0	0	0

Bit/Field	Name	Type	Reset	Description
31:4	reserved	RO	0x00	Software should not rely on the value of a reserved bit. To provide compatibility with future products, the value of a reserved bit should be preserved across a read-modify-write operation.
3	INR3	RO	0	SS3 Raw Interrupt Status Set by hardware when a sample with its respective ADCSSCTL3 <small>IE</small> bit has completed conversion. This bit is cleared by writing a 1 to the ADCISC <small>IN3</small> bit.
2	INR2	RO	0	SS2 Raw Interrupt Status Set by hardware when a sample with its respective ADCSSCTL2 <small>IE</small> bit has completed conversion. This bit is cleared by writing a 1 to the ADCISC <small>IN2</small> bit.
1	INR1	RO	0	SS1 Raw Interrupt Status Set by hardware when a sample with its respective ADCSSCTL1 <small>IE</small> bit has completed conversion. This bit is cleared by writing a 1 to the ADCISC <small>IN1</small> bit.
0	INR0	RO	0	SS0 Raw Interrupt Status Set by hardware when a sample with its respective ADCSSCTL0 <small>IE</small> bit has completed conversion. This bit is cleared by writing a 1 to the ADCISC <small>IN0</small> bit.

Register 3: ADC Interrupt Mask (ADCIM), offset 0x008

This register controls whether the Sample Sequencer raw interrupt signals are promoted to controller interrupts. The raw interrupt signal for each Sample Sequencer can be masked independently.

ADC Interrupt Mask (ADCIM)

Base 0x4003.8000
 Offset 0x008
 Type R/W, reset 0x0000.0000

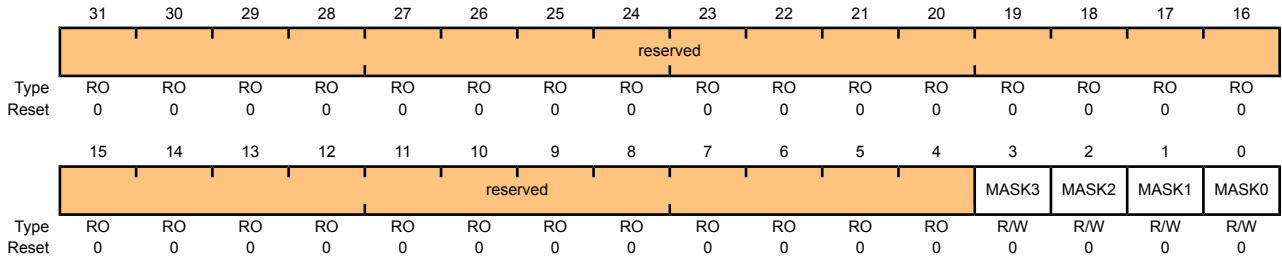

Bit/Field	Name	Type	Reset	Description
31:4	reserved	RO	0x00	Software should not rely on the value of a reserved bit. To provide compatibility with future products, the value of a reserved bit should be preserved across a read-modify-write operation.
3	MASK3	R/W	0	SS3 Interrupt Mask Specifies whether the raw interrupt signal from Sample Sequencer 3 (ADCRIS register <i>INR3</i> bit) is promoted to a controller interrupt. If set, the raw interrupt signal is promoted to a controller interrupt. Otherwise, it is not.
2	MASK2	R/W	0	SS2 Interrupt Mask Specifies whether the raw interrupt signal from Sample Sequencer 2 (ADCRIS register <i>INR2</i> bit) is promoted to a controller interrupt. If set, the raw interrupt signal is promoted to a controller interrupt. Otherwise, it is not.
1	MASK1	R/W	0	SS1 Interrupt Mask Specifies whether the raw interrupt signal from Sample Sequencer 1 (ADCRIS register <i>INR1</i> bit) is promoted to a controller interrupt. If set, the raw interrupt signal is promoted to a controller interrupt. Otherwise, it is not.
0	MASK0	R/W	0	SS0 Interrupt Mask Specifies whether the raw interrupt signal from Sample Sequencer 0 (ADCRIS register <i>INR0</i> bit) is promoted to a controller interrupt. If set, the raw interrupt signal is promoted to a controller interrupt. Otherwise, it is not.

Register 4: ADC Interrupt Status and Clear (ADCISC), offset 0x00C

This register provides the mechanism for clearing interrupt conditions, and shows the status of controller interrupts generated by the Sample Sequencers. When read, each bit field is the logical AND of the respective `INR` and `MASK` bits. Interrupts are cleared by writing a 1 to the corresponding bit position. If software is polling the `ADCRIS` instead of generating interrupts, the `INR` bits are still cleared via the `ADCISC` register, even if the `IN` bit is not set.

ADC Interrupt Status and Clear (ADCISC)

Base 0x4003.8000
Offset 0x00C
Type R/W1C, reset 0x0000.0000

	31	30	29	28	27	26	25	24	23	22	21	20	19	18	17	16	
	reserved																
Type	RO	RO	RO	RO	RO	RO	RO	RO	RO	RO	RO	RO	RO	RO	RO	RO	
Reset	0	0	0	0	0	0	0	0	0	0	0	0	0	0	0	0	
	15	14	13	12	11	10	9	8	7	6	5	4	3	2	1	0	
	reserved													IN3	IN2	IN1	IN0
Type	RO	RO	RO	RO	RO	RO	RO	RO	RO	RO	RO	RO	RO	R/W1C	R/W1C	R/W1C	R/W1C
Reset	0	0	0	0	0	0	0	0	0	0	0	0	0	0	0	0	0

Bit/Field	Name	Type	Reset	Description
31:4	reserved	RO	0x00	Software should not rely on the value of a reserved bit. To provide compatibility with future products, the value of a reserved bit should be preserved across a read-modify-write operation.
3	IN3	R/W1C	0	SS3 Interrupt Status and Clear This bit is set by hardware when the <code>MASK3</code> and <code>INR3</code> bits are both 1, providing a level-based interrupt to the controller. It is cleared by writing a 1, and also clears the <code>INR3</code> bit.
2	IN2	R/W1C	0	SS2 Interrupt Status and Clear This bit is set by hardware when the <code>MASK2</code> and <code>INR2</code> bits are both 1, providing a level based interrupt to the controller. It is cleared by writing a 1, and also clears the <code>INR2</code> bit.
1	IN1	R/W1C	0	SS1 Interrupt Status and Clear This bit is set by hardware when the <code>MASK1</code> and <code>INR1</code> bits are both 1, providing a level based interrupt to the controller. It is cleared by writing a 1, and also clears the <code>INR1</code> bit.
0	IN0	R/W1C	0	SS0 Interrupt Status and Clear This bit is set by hardware when the <code>MASK0</code> and <code>INR0</code> bits are both 1, providing a level based interrupt to the controller. It is cleared by writing a 1, and also clears the <code>INR0</code> bit.

Register 5: ADC Overflow Status (ADCOSTAT), offset 0x010

This register indicates overflow conditions in the Sample Sequencer FIFOs. Once the overflow condition has been handled by software, the condition can be cleared by writing a 1 to the corresponding bit position.

ADC Overflow Status (ADCOSTAT)

Base 0x4003.8000
 Offset 0x010
 Type R/W1C, reset 0x0000.0000

	31	30	29	28	27	26	25	24	23	22	21	20	19	18	17	16
	reserved															
Type	RO	RO	RO	RO	RO	RO	RO	RO	RO	RO	RO	RO	RO	RO	RO	RO
Reset	0	0	0	0	0	0	0	0	0	0	0	0	0	0	0	0
	15	14	13	12	11	10	9	8	7	6	5	4	3	2	1	0
	reserved												OV3	OV2	OV1	OV0
Type	RO	RO	RO	RO	RO	RO	RO	RO	RO	RO	RO	RO	R/W1C	R/W1C	R/W1C	R/W1C
Reset	0	0	0	0	0	0	0	0	0	0	0	0	0	0	0	0

Bit/Field	Name	Type	Reset	Description
31:4	reserved	RO	0x00	Software should not rely on the value of a reserved bit. To provide compatibility with future products, the value of a reserved bit should be preserved across a read-modify-write operation.
3	OV3	R/W1C	0	<p>SS3 FIFO Overflow</p> <p>This bit specifies that the FIFO for Sample Sequencer 3 has hit an overflow condition where the FIFO is full and a write was requested. When an overflow is detected, the most recent write is dropped and this bit is set by hardware to indicate the occurrence of dropped data. This bit is cleared by writing a 1.</p>
2	OV2	R/W1C	0	<p>SS2 FIFO Overflow</p> <p>This bit specifies that the FIFO for Sample Sequencer 2 has hit an overflow condition where the FIFO is full and a write was requested. When an overflow is detected, the most recent write is dropped and this bit is set by hardware to indicate the occurrence of dropped data. This bit is cleared by writing a 1.</p>
1	OV1	R/W1C	0	<p>SS1 FIFO Overflow</p> <p>This bit specifies that the FIFO for Sample Sequencer 1 has hit an overflow condition where the FIFO is full and a write was requested. When an overflow is detected, the most recent write is dropped and this bit is set by hardware to indicate the occurrence of dropped data. This bit is cleared by writing a 1.</p>
0	OV0	R/W1C	0	<p>SS0 FIFO Overflow</p> <p>This bit specifies that the FIFO for Sample Sequencer 0 has hit an overflow condition where the FIFO is full and a write was requested. When an overflow is detected, the most recent write is dropped and this bit is set by hardware to indicate the occurrence of dropped data. This bit is cleared by writing a 1.</p>

Register 6: ADC Event Multiplexer Select (ADCEMUX), offset 0x014

The **ADCEMUX** selects the event (trigger) that initiates sampling for each Sample Sequencer. Each Sample Sequencer can be configured with a unique trigger source.

ADC Event Multiplexer Select (ADCEMUX)

Base 0x4003.8000
 Offset 0x014
 Type R/W, reset 0x0000.0000

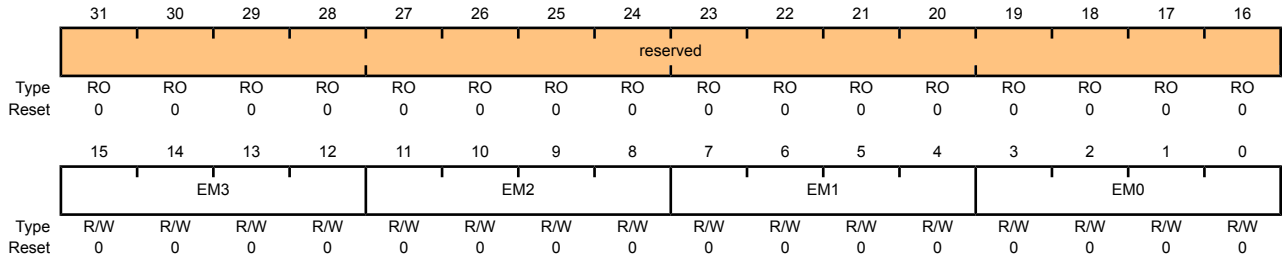

Bit/Field	Name	Type	Reset	Description																								
31:16	reserved	RO	0x00	Software should not rely on the value of a reserved bit. To provide compatibility with future products, the value of a reserved bit should be preserved across a read-modify-write operation.																								
15:12	EM3	R/W	0x00	SS3 Trigger Select This field selects the trigger source for Sample Sequencer 3. The valid configurations for this field are: <table border="1" style="margin-left: 20px;"> <thead> <tr> <th>Value</th> <th>Event</th> </tr> </thead> <tbody> <tr><td>0x0</td><td>Controller (default)</td></tr> <tr><td>0x1</td><td>Reserved</td></tr> <tr><td>0x2</td><td>Reserved</td></tr> <tr><td>0x3</td><td>Reserved</td></tr> <tr><td>0x4</td><td>External (GPIO PB4)</td></tr> <tr><td>0x5</td><td>Timer</td></tr> <tr><td>0x6</td><td>Reserved</td></tr> <tr><td>0x7</td><td>Reserved</td></tr> <tr><td>0x8</td><td>Reserved</td></tr> <tr><td>0x9-0xE</td><td>reserved</td></tr> <tr><td>0xF</td><td>Always (continuously sample)</td></tr> </tbody> </table>	Value	Event	0x0	Controller (default)	0x1	Reserved	0x2	Reserved	0x3	Reserved	0x4	External (GPIO PB4)	0x5	Timer	0x6	Reserved	0x7	Reserved	0x8	Reserved	0x9-0xE	reserved	0xF	Always (continuously sample)
Value	Event																											
0x0	Controller (default)																											
0x1	Reserved																											
0x2	Reserved																											
0x3	Reserved																											
0x4	External (GPIO PB4)																											
0x5	Timer																											
0x6	Reserved																											
0x7	Reserved																											
0x8	Reserved																											
0x9-0xE	reserved																											
0xF	Always (continuously sample)																											

Bit/Field	Name	Type	Reset	Description																								
11:8	EM2	R/W	0x00	<p>SS2 Trigger Select</p> <p>This field selects the trigger source for Sample Sequencer 2.</p> <p>The valid configurations for this field are:</p> <table border="1"><thead><tr><th>Value</th><th>Event</th></tr></thead><tbody><tr><td>0x0</td><td>Controller (default)</td></tr><tr><td>0x1</td><td>Reserved</td></tr><tr><td>0x2</td><td>Reserved</td></tr><tr><td>0x3</td><td>Reserved</td></tr><tr><td>0x4</td><td>External (GPIO PB4)</td></tr><tr><td>0x5</td><td>Timer</td></tr><tr><td>0x6</td><td>Reserved</td></tr><tr><td>0x7</td><td>Reserved</td></tr><tr><td>0x8</td><td>Reserved</td></tr><tr><td>0x9-0xE</td><td>reserved</td></tr><tr><td>0xF</td><td>Always (continuously sample)</td></tr></tbody></table>	Value	Event	0x0	Controller (default)	0x1	Reserved	0x2	Reserved	0x3	Reserved	0x4	External (GPIO PB4)	0x5	Timer	0x6	Reserved	0x7	Reserved	0x8	Reserved	0x9-0xE	reserved	0xF	Always (continuously sample)
Value	Event																											
0x0	Controller (default)																											
0x1	Reserved																											
0x2	Reserved																											
0x3	Reserved																											
0x4	External (GPIO PB4)																											
0x5	Timer																											
0x6	Reserved																											
0x7	Reserved																											
0x8	Reserved																											
0x9-0xE	reserved																											
0xF	Always (continuously sample)																											
7:4	EM1	R/W	0x00	<p>SS1 Trigger Select</p> <p>This field selects the trigger source for Sample Sequencer 1.</p> <p>The valid configurations for this field are:</p> <table border="1"><thead><tr><th>Value</th><th>Event</th></tr></thead><tbody><tr><td>0x0</td><td>Controller (default)</td></tr><tr><td>0x1</td><td>Reserved</td></tr><tr><td>0x2</td><td>Reserved</td></tr><tr><td>0x3</td><td>Reserved</td></tr><tr><td>0x4</td><td>External (GPIO PB4)</td></tr><tr><td>0x5</td><td>Timer</td></tr><tr><td>0x6</td><td>Reserved</td></tr><tr><td>0x7</td><td>Reserved</td></tr><tr><td>0x8</td><td>Reserved</td></tr><tr><td>0x9-0xE</td><td>reserved</td></tr><tr><td>0xF</td><td>Always (continuously sample)</td></tr></tbody></table>	Value	Event	0x0	Controller (default)	0x1	Reserved	0x2	Reserved	0x3	Reserved	0x4	External (GPIO PB4)	0x5	Timer	0x6	Reserved	0x7	Reserved	0x8	Reserved	0x9-0xE	reserved	0xF	Always (continuously sample)
Value	Event																											
0x0	Controller (default)																											
0x1	Reserved																											
0x2	Reserved																											
0x3	Reserved																											
0x4	External (GPIO PB4)																											
0x5	Timer																											
0x6	Reserved																											
0x7	Reserved																											
0x8	Reserved																											
0x9-0xE	reserved																											
0xF	Always (continuously sample)																											

Bit/Field	Name	Type	Reset	Description																								
3:0	EM0	R/W	0x00	SS0 Trigger Select This field selects the trigger source for Sample Sequencer 0. The valid configurations for this field are: <table><thead><tr><th>Value</th><th>Event</th></tr></thead><tbody><tr><td>0x0</td><td>Controller (default)</td></tr><tr><td>0x1</td><td>Reserved</td></tr><tr><td>0x2</td><td>Reserved</td></tr><tr><td>0x3</td><td>Reserved</td></tr><tr><td>0x4</td><td>External (GPIO PB4)</td></tr><tr><td>0x5</td><td>Timer</td></tr><tr><td>0x6</td><td>Reserved</td></tr><tr><td>0x7</td><td>Reserved</td></tr><tr><td>0x8</td><td>Reserved</td></tr><tr><td>0x9-0xE</td><td>reserved</td></tr><tr><td>0xF</td><td>Always (continuously sample)</td></tr></tbody></table>	Value	Event	0x0	Controller (default)	0x1	Reserved	0x2	Reserved	0x3	Reserved	0x4	External (GPIO PB4)	0x5	Timer	0x6	Reserved	0x7	Reserved	0x8	Reserved	0x9-0xE	reserved	0xF	Always (continuously sample)
Value	Event																											
0x0	Controller (default)																											
0x1	Reserved																											
0x2	Reserved																											
0x3	Reserved																											
0x4	External (GPIO PB4)																											
0x5	Timer																											
0x6	Reserved																											
0x7	Reserved																											
0x8	Reserved																											
0x9-0xE	reserved																											
0xF	Always (continuously sample)																											

Register 7: ADC Underflow Status (ADCUSTAT), offset 0x018

This register indicates underflow conditions in the Sample Sequencer FIFOs. The corresponding underflow condition can be cleared by writing a 1 to the relevant bit position.

ADC Underflow Status (ADCUSTAT)

Base 0x4003.8000
 Offset 0x018
 Type R/W1C, reset 0x0000.0000

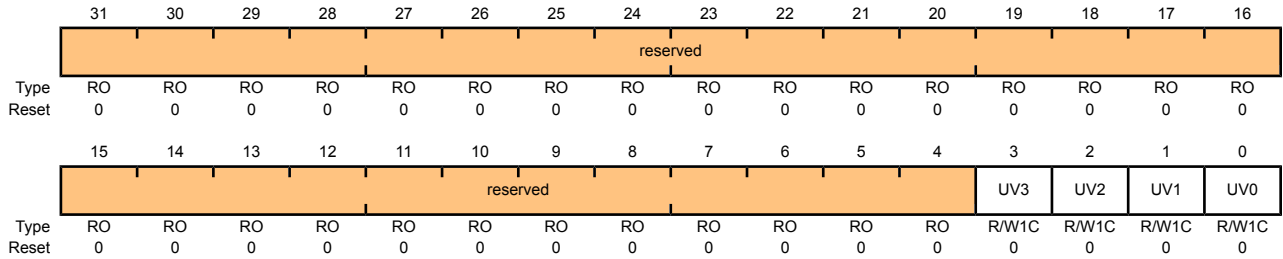

Bit/Field	Name	Type	Reset	Description
31:4	reserved	RO	0x00	Software should not rely on the value of a reserved bit. To provide compatibility with future products, the value of a reserved bit should be preserved across a read-modify-write operation.
3	UV3	R/W1C	0	SS3 FIFO Underflow This bit specifies that the FIFO for Sample Sequencer 3 has hit an underflow condition where the FIFO is empty and a read was requested. The problematic read does not move the FIFO pointers, and 0s are returned. This bit is cleared by writing a 1.
2	UV2	R/W1C	0	SS2 FIFO Underflow This bit specifies that the FIFO for Sample Sequencer 2 has hit an underflow condition where the FIFO is empty and a read was requested. The problematic read does not move the FIFO pointers, and 0s are returned. This bit is cleared by writing a 1.
1	UV1	R/W1C	0	SS1 FIFO Underflow This bit specifies that the FIFO for Sample Sequencer 1 has hit an underflow condition where the FIFO is empty and a read was requested. The problematic read does not move the FIFO pointers, and 0s are returned. This bit is cleared by writing a 1.
0	UV0	R/W1C	0	SS0 FIFO Underflow This bit specifies that the FIFO for Sample Sequencer 0 has hit an underflow condition where the FIFO is empty and a read was requested. The problematic read does not move the FIFO pointers, and 0s are returned. This bit is cleared by writing a 1.

Register 8: ADC Sample Sequencer Priority (ADCSSPRI), offset 0x020

This register sets the priority for each of the Sample Sequencers. Out of reset, Sequencer 0 has the highest priority, and sample sequence 3 has the lowest priority. When reconfiguring sequence priorities, each sequence must have a unique priority or the ADC behavior is inconsistent.

ADC Sample Sequencer Priority (ADCSSPRI)

Base 0x4003.8000
Offset 0x020
Type R/W, reset 0x0000.3210

	31	30	29	28	27	26	25	24	23	22	21	20	19	18	17	16
	reserved															
Type	RO	RO	RO	RO	RO	RO	RO	RO	RO	RO	RO	RO	RO	RO	RO	RO
Reset	0	0	0	0	0	0	0	0	0	0	0	0	0	0	0	0
	15	14	13	12	11	10	9	8	7	6	5	4	3	2	1	0
	reserved		SS3		reserved		SS2		reserved		SS1		reserved		SS0	
Type	RO	RO	R/W	R/W	RO	RO	R/W	R/W	RO	RO	R/W	R/W	RO	RO	R/W	R/W
Reset	0	0	1	1	0	0	1	0	0	0	0	1	0	0	0	0

Bit/Field	Name	Type	Reset	Description
31:14	reserved	RO	0x00	Software should not rely on the value of a reserved bit. To provide compatibility with future products, the value of a reserved bit should be preserved across a read-modify-write operation.
13:12	SS3	R/W	0x3	SS3 Priority The SS3 field contains a binary-encoded value that specifies the priority encoding of Sample Sequencer 3. A priority encoding of 0 is highest and 3 is lowest. The priorities assigned to the Sequencers must be uniquely mapped. ADC behavior is not consistent if two or more fields are equal.
11:10	reserved	RO	0x0	Software should not rely on the value of a reserved bit. To provide compatibility with future products, the value of a reserved bit should be preserved across a read-modify-write operation.
9:8	SS2	R/W	0x2	SS2 Priority The SS2 field contains a binary-encoded value that specifies the priority encoding of Sample Sequencer 2.
7:6	reserved	RO	0x0	Software should not rely on the value of a reserved bit. To provide compatibility with future products, the value of a reserved bit should be preserved across a read-modify-write operation.
5:4	SS1	R/W	0x1	SS1 Priority The SS1 field contains a binary-encoded value that specifies the priority encoding of Sample Sequencer 1.
3:2	reserved	RO	0x0	Software should not rely on the value of a reserved bit. To provide compatibility with future products, the value of a reserved bit should be preserved across a read-modify-write operation.
1:0	SS0	R/W	0x0	SS0 Priority The SS0 field contains a binary-encoded value that specifies the priority encoding of Sample Sequencer 0.

Register 9: ADC Processor Sample Sequence Initiate (ADCPSSI), offset 0x028

This register provides a mechanism for application software to initiate sampling in the Sample Sequencers. Sample sequences can be initiated individually or in any combination. When multiple sequences are triggered simultaneously, the priority encodings in **ADCSSPRI** dictate execution order.

ADC Processor Sample Sequence Initiate (ADCPSSI)

Base 0x4003.8000
 Offset 0x028
 Type WO, reset -



Bit/Field	Name	Type	Reset	Description
31:4	reserved	WO	-	Software should not rely on the value of a reserved bit. To provide compatibility with future products, the value of a reserved bit should be preserved across a read-modify-write operation.
3	SS3	WO	-	SS3 Initiate Only a write by software is valid; a read of the register returns no meaningful data. When set by software, sampling is triggered on Sample Sequencer 3, assuming the Sequencer is enabled in the ADCACTSS register.
2	SS2	WO	-	SS2 Initiate Only a write by software is valid; a read of the register returns no meaningful data. When set by software, sampling is triggered on Sample Sequencer 2, assuming the Sequencer is enabled in the ADCACTSS register.
1	SS1	WO	-	SS1 Initiate Only a write by software is valid; a read of the register returns no meaningful data. When set by software, sampling is triggered on Sample Sequencer 1, assuming the Sequencer is enabled in the ADCACTSS register.
0	SS0	WO	-	SS0 Initiate Only a write by software is valid; a read of the register returns no meaningful data. When set by software, sampling is triggered on Sample Sequencer 0, assuming the Sequencer is enabled in the ADCACTSS register.

Register 10: ADC Sample Averaging Control (ADCSAC), offset 0x030

This register controls the amount of hardware averaging applied to conversion results. The final conversion result stored in the FIFO is averaged from 2^{AVG} consecutive ADC samples at the specified ADC speed. If AVG is 0, the sample is passed directly through without any averaging. If AVG=6, then 64 consecutive ADC samples are averaged to generate one result in the sequencer FIFO. An AVG = 7 provides unpredictable results.

ADC Sample Averaging Control (ADCSAC)

Base 0x4003.8000
 Offset 0x030
 Type R/W, reset 0x0000.0000

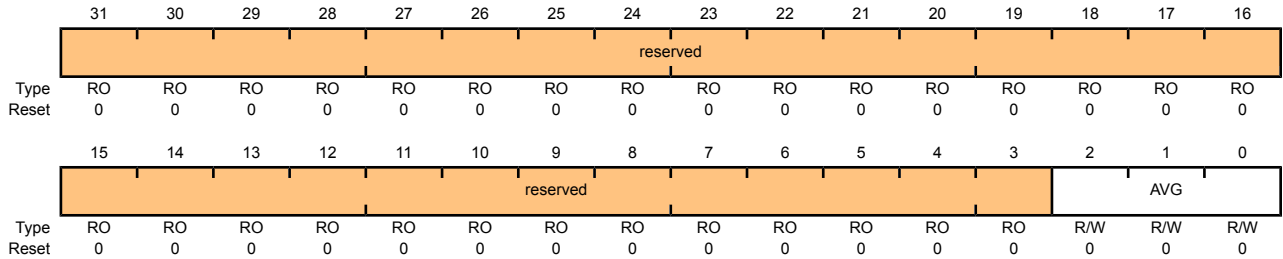

Bit/Field	Name	Type	Reset	Description
31:3	reserved	RO	0x00	Software should not rely on the value of a reserved bit. To provide compatibility with future products, the value of a reserved bit should be preserved across a read-modify-write operation.
2:0	AVG	R/W	0x0	Hardware Averaging Control Specifies the amount of hardware averaging that will be applied to ADC samples. The AVG field can be any value between 0 and 6. Entering a value of 7 creates unpredictable results.

Value	Description
0x0	No hardware oversampling
0x1	2x hardware oversampling
0x2	4x hardware oversampling
0x3	8x hardware oversampling
0x4	16x hardware oversampling
0x5	32x hardware oversampling
0x6	64x hardware oversampling
0x7	Reserved

Register 11: ADC Sample Sequence Input Multiplexer Select 0 (ADCSSMUX0), offset 0x040

This register defines the analog input configuration for each sample in a sequence executed with Sample Sequencer 0.

This register is 32-bits wide and contains information for eight possible samples.

ADC Sample Sequence Input Multiplexer Select 0 (ADCSSMUX0)

Base 0x4003.8000
 Offset 0x040
 Type R/W, reset 0x0000.0000

	31	30	29	28	27	26	25	24	23	22	21	20	19	18	17	16
	reserved	MUX7			reserved	MUX6			reserved	MUX5			reserved	MUX4		
Type	RO	R/W	R/W	R/W	RO	R/W	R/W	R/W	RO	R/W	R/W	R/W	RO	R/W	R/W	R/W
Reset	0	0	0	0	0	0	0	0	0	0	0	0	0	0	0	0
	15	14	13	12	11	10	9	8	7	6	5	4	3	2	1	0
	reserved	MUX3			reserved	MUX2			reserved	MUX1			reserved	MUX0		
Type	RO	R/W	R/W	R/W	RO	R/W	R/W	R/W	RO	R/W	R/W	R/W	RO	R/W	R/W	R/W
Reset	0	0	0	0	0	0	0	0	0	0	0	0	0	0	0	0

Bit/Field	Name	Type	Reset	Description
31	reserved	RO	0	Software should not rely on the value of a reserved bit. To provide compatibility with future products, the value of a reserved bit should be preserved across a read-modify-write operation.
30:28	MUX7	R/W	0	8th Sample Input Select The MUX7 field is used during the eighth sample of a sequence executed with the Sample Sequencer. It specifies which of the analog inputs is sampled for the analog-to-digital conversion. The value set here indicates the corresponding pin, for example, a value of 1 indicates the input is ADC1.
27	reserved	RO	0	Software should not rely on the value of a reserved bit. To provide compatibility with future products, the value of a reserved bit should be preserved across a read-modify-write operation.
26:24	MUX6	R/W	0	7th Sample Input Select The MUX6 field is used during the seventh sample of a sequence executed with the Sample Sequencer and specifies which of the analog inputs is sampled for the analog-to-digital conversion.
23	reserved	RO	0	Software should not rely on the value of a reserved bit. To provide compatibility with future products, the value of a reserved bit should be preserved across a read-modify-write operation.
22:20	MUX5	R/W	0	6th Sample Input Select The MUX5 field is used during the sixth sample of a sequence executed with the Sample Sequencer and specifies which of the analog inputs is sampled for the analog-to-digital conversion.
19	reserved	RO	0	Software should not rely on the value of a reserved bit. To provide compatibility with future products, the value of a reserved bit should be preserved across a read-modify-write operation.

Bit/Field	Name	Type	Reset	Description
18:16	MUX4	R/W	0	<p>5th Sample Input Select</p> <p>The MUX4 field is used during the fifth sample of a sequence executed with the Sample Sequencer and specifies which of the analog inputs is sampled for the analog-to-digital conversion.</p>
15	reserved	RO	0	Software should not rely on the value of a reserved bit. To provide compatibility with future products, the value of a reserved bit should be preserved across a read-modify-write operation.
14:12	MUX3	R/W	0	<p>4th Sample Input Select</p> <p>The MUX3 field is used during the fourth sample of a sequence executed with the Sample Sequencer and specifies which of the analog inputs is sampled for the analog-to-digital conversion.</p>
11	reserved	RO	0	Software should not rely on the value of a reserved bit. To provide compatibility with future products, the value of a reserved bit should be preserved across a read-modify-write operation.
10:8	MUX2	R/W	0	<p>3rd Sample Input Select</p> <p>The MUX2 field is used during the third sample of a sequence executed with the Sample Sequencer and specifies which of the analog inputs is sampled for the analog-to-digital conversion.</p>
7	reserved	RO	0	Software should not rely on the value of a reserved bit. To provide compatibility with future products, the value of a reserved bit should be preserved across a read-modify-write operation.
6:4	MUX1	R/W	0	<p>2nd Sample Input Select</p> <p>The MUX1 field is used during the second sample of a sequence executed with the Sample Sequencer and specifies which of the analog inputs is sampled for the analog-to-digital conversion.</p>
3	reserved	RO	0	Software should not rely on the value of a reserved bit. To provide compatibility with future products, the value of a reserved bit should be preserved across a read-modify-write operation.
2:0	MUX0	R/W	0	<p>1st Sample Input Select</p> <p>The MUX0 field is used during the first sample of a sequence executed with the Sample Sequencer and specifies which of the analog inputs is sampled for the analog-to-digital conversion.</p>

Register 12: ADC Sample Sequence Control 0 (ADCSSCTL0), offset 0x044

This register contains the configuration information for each sample for a sequence executed with Sample Sequencer 0. When configuring a sample sequence, the `END` bit must be set at some point, whether it be after the first sample, last sample, or any sample in between.

This register is 32-bits wide and contains information for eight possible samples.

ADC Sample Sequence Control 0 (ADCSSCTL0)

Base 0x4003.8000
 Offset 0x044
 Type R/W, reset 0x0000.0000

	31	30	29	28	27	26	25	24	23	22	21	20	19	18	17	16
	TS7	IE7	END7	D7	TS6	IE6	END6	D6	TS5	IE5	END5	D5	TS4	IE4	END4	D4
Type	R/W	R/W	R/W	R/W	R/W	R/W	R/W	R/W	R/W	R/W	R/W	R/W	R/W	R/W	R/W	R/W
Reset	0	0	0	0	0	0	0	0	0	0	0	0	0	0	0	0
	15	14	13	12	11	10	9	8	7	6	5	4	3	2	1	0
	TS3	IE3	END3	D3	TS2	IE2	END2	D2	TS1	IE1	END1	D1	TS0	IE0	END0	D0
Type	R/W	R/W	R/W	R/W	R/W	R/W	R/W	R/W	R/W	R/W	R/W	R/W	R/W	R/W	R/W	R/W
Reset	0	0	0	0	0	0	0	0	0	0	0	0	0	0	0	0

Bit/Field	Name	Type	Reset	Description
31	TS7	R/W	0	<p>8th Sample Temp Sensor Select</p> <p>The <code>TS7</code> bit is used during the eighth sample of the sample sequence and specifies the input source of the sample. If set, the temperature sensor is read. Otherwise, the input pin specified by the <code>ADCSSMUX</code> register is read.</p>
30	IE7	R/W	0	<p>8th Sample Interrupt Enable</p> <p>The <code>IE7</code> bit is used during the eighth sample of the sample sequence and specifies whether the raw interrupt signal (<code>INR0</code> bit) is asserted at the end of the sample's conversion. If the <code>MASK0</code> bit in the <code>ADCIM</code> register is set, the interrupt is promoted to a controller-level interrupt. When this bit is set, the raw interrupt is asserted, otherwise it is not. It is legal to have multiple samples within a sequence generate interrupts.</p>
29	END7	R/W	0	<p>8th Sample is End of Sequence</p> <p>The <code>END7</code> bit indicates that this is the last sample of the sequence. It is possible to end the sequence on any sample position. Samples defined after the sample containing a set <code>END</code> are not requested for conversion even though the fields may be non-zero. It is required that software write the <code>END</code> bit somewhere within the sequence. (Sample Sequencer 3, which only has a single sample in the sequence, is hardwired to have the <code>END0</code> bit set.)</p> <p>Setting this bit indicates that this sample is the last in the sequence.</p>
28	D7	R/W	0	<p>8th Sample Diff Input Select</p> <p>The <code>D7</code> bit indicates that the analog input is to be differentially sampled. The corresponding <code>ADCSSMUXx</code> nibble must be set to the pair number "i", where the paired inputs are "2i and 2i+1". The temperature sensor does not have a differential option. When set, the analog inputs are differentially sampled.</p>
27	TS6	R/W	0	<p>7th Sample Temp Sensor Select</p> <p>Same definition as <code>TS7</code> but used during the seventh sample.</p>

Bit/Field	Name	Type	Reset	Description
26	IE6	R/W	0	7th Sample Interrupt Enable Same definition as IE7 but used during the seventh sample.
25	END6	R/W	0	7th Sample is End of Sequence Same definition as END7 but used during the seventh sample.
24	D6	R/W	0	7th Sample Diff Input Select Same definition as D7 but used during the seventh sample.
23	TS5	R/W	0	6th Sample Temp Sensor Select Same definition as TS7 but used during the sixth sample.
22	IE5	R/W	0	6th Sample Interrupt Enable Same definition as IE7 but used during the sixth sample.
21	END5	R/W	0	6th Sample is End of Sequence Same definition as END7 but used during the sixth sample.
20	D5	R/W	0	6th Sample Diff Input Select Same definition as D7 but used during the sixth sample.
19	TS4	R/W	0	5th Sample Temp Sensor Select Same definition as TS7 but used during the fifth sample.
18	IE4	R/W	0	5th Sample Interrupt Enable Same definition as IE7 but used during the fifth sample.
17	END4	R/W	0	5th Sample is End of Sequence Same definition as END7 but used during the fifth sample.
16	D4	R/W	0	5th Sample Diff Input Select Same definition as D7 but used during the fifth sample.
15	TS3	R/W	0	4th Sample Temp Sensor Select Same definition as TS7 but used during the fourth sample.
14	IE3	R/W	0	4th Sample Interrupt Enable Same definition as IE7 but used during the fourth sample.
13	END3	R/W	0	4th Sample is End of Sequence Same definition as END7 but used during the fourth sample.
12	D3	R/W	0	4th Sample Diff Input Select Same definition as D7 but used during the fourth sample.
11	TS2	R/W	0	3rd Sample Temp Sensor Select Same definition as TS7 but used during the third sample.

Bit/Field	Name	Type	Reset	Description
10	IE2	R/W	0	3rd Sample Interrupt Enable Same definition as IE7 but used during the third sample.
9	END2	R/W	0	3rd Sample is End of Sequence Same definition as END7 but used during the third sample.
8	D2	R/W	0	3rd Sample Diff Input Select Same definition as D7 but used during the third sample.
7	TS1	R/W	0	2nd Sample Temp Sensor Select Same definition as TS7 but used during the second sample.
6	IE1	R/W	0	2nd Sample Interrupt Enable Same definition as IE7 but used during the second sample.
5	END1	R/W	0	2nd Sample is End of Sequence Same definition as END7 but used during the second sample.
4	D1	R/W	0	2nd Sample Diff Input Select Same definition as D7 but used during the second sample.
3	TS0	R/W	0	1st Sample Temp Sensor Select Same definition as TS7 but used during the first sample.
2	IE0	R/W	0	1st Sample Interrupt Enable Same definition as IE7 but used during the first sample.
1	END0	R/W	0	1st Sample is End of Sequence Same definition as END7 but used during the first sample. Since this sequencer has only one entry, this bit must be set.
0	D0	R/W	0	1st Sample Diff Input Select Same definition as D7 but used during the first sample.

Register 13: ADC Sample Sequence Result FIFO 0 (ADCSSFIFO0), offset 0x048

Register 14: ADC Sample Sequence Result FIFO 1 (ADCSSFIFO1), offset 0x068

Register 15: ADC Sample Sequence Result FIFO 2 (ADCSSFIFO2), offset 0x088

Register 16: ADC Sample Sequence Result FIFO 3 (ADCSSFIFO3), offset 0x0A8

This register contains the conversion results for samples collected with the Sample Sequencer (the **ADCSSFIFO0** register is used for Sample Sequencer 0, **ADCSSFIFO1** for Sequencer 1, **ADCSSFIFO2** for Sequencer 2, and **ADCSSFIFO3** for Sequencer 3). Reads of this register return conversion result data in the order sample 0, sample 1, and so on, until the FIFO is empty. If the FIFO is not properly handled by software, overflow and underflow conditions are registered in the **ADCOSTAT** and **ADCUSTAT** registers.

ADC Sample Sequence Result FIFO 0 (ADCSSFIFO0)

Base 0x4003.8000

Offset 0x048

Type RO, reset 0x0000.0000

	31	30	29	28	27	26	25	24	23	22	21	20	19	18	17	16
	reserved															
Type	RO	RO	RO	RO	RO	RO	RO	RO	RO	RO	RO	RO	RO	RO	RO	RO
Reset	0	0	0	0	0	0	0	0	0	0	0	0	0	0	0	0
	15	14	13	12	11	10	9	8	7	6	5	4	3	2	1	0
	reserved						DATA									
Type	RO	RO	RO	RO	RO	RO	RO	RO	RO	RO	RO	RO	RO	RO	RO	RO
Reset	0	0	0	0	0	0	0	0	0	0	0	0	0	0	0	0

Bit/Field	Name	Type	Reset	Description
31:10	reserved	RO	0x00	Software should not rely on the value of a reserved bit. To provide compatibility with future products, the value of a reserved bit should be preserved across a read-modify-write operation.
9:0	DATA	RO	0x00	Conversion Result Data

Register 17: ADC Sample Sequence FIFO 0 Status (ADCSSFSTAT0), offset 0x04C

Register 18: ADC Sample Sequence FIFO 1 Status (ADCSSFSTAT1), offset 0x06C

Register 19: ADC Sample Sequence FIFO 2 Status (ADCSSFSTAT2), offset 0x08C

Register 20: ADC Sample Sequence FIFO 3 Status (ADCSSFSTAT3), offset 0x0AC

This register provides a window into the Sample Sequencer, providing full/empty status information as well as the positions of the head and tail pointers. The reset value of 0x100 indicates an empty FIFO. The **ADCSSFSTAT0** register provides status on FIFO0, **ADCSSFSTAT1** on FIFO1, **ADCSSFSTAT2** on FIFO2, and **ADCSSFSTAT3** on FIFO3.

ADC Sample Sequence FIFO 0 Status (ADCSSFSTAT0)

Base 0x4003.8000
 Offset 0x04C
 Type RO, reset 0x0000.0100

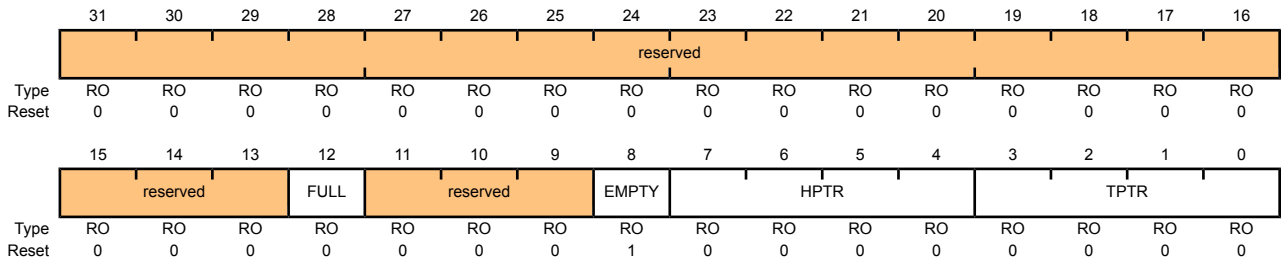

Bit/Field	Name	Type	Reset	Description
31:13	reserved	RO	0x00	Software should not rely on the value of a reserved bit. To provide compatibility with future products, the value of a reserved bit should be preserved across a read-modify-write operation.
12	FULL	RO	0	FIFO Full When set, indicates that the FIFO is currently full.
11:9	reserved	RO	0x00	Software should not rely on the value of a reserved bit. To provide compatibility with future products, the value of a reserved bit should be preserved across a read-modify-write operation.
8	EMPTY	RO	1	FIFO Empty When set, indicates that the FIFO is currently empty.
7:4	HPTR	RO	0x00	FIFO Head Pointer This field contains the current "head" pointer index for the FIFO, that is, the next entry to be written.
3:0	TPTR	RO	0x00	FIFO Tail Pointer This field contains the current "tail" pointer index for the FIFO, that is, the next entry to be read.

Register 21: ADC Sample Sequence Input Multiplexer Select 1 (ADCSSMUX1), offset 0x060

Register 22: ADC Sample Sequence Input Multiplexer Select 2 (ADCSSMUX2), offset 0x080

This register defines the analog input configuration for each sample in a sequence executed with Sample Sequencer 1 or 2. These registers are 16-bits wide and contain information for four possible samples. See the **ADCSSMUX0** register on page 242 for detailed bit descriptions.

ADC Sample Sequence Input Multiplexer Select 1 (ADCSSMUX1)

Base 0x4003.8000
 Offset 0x060
 Type R/W, reset 0x0000.0000

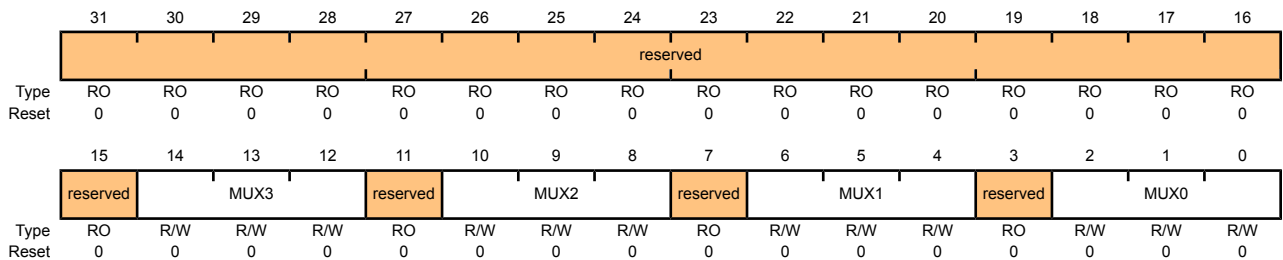

Bit/Field	Name	Type	Reset	Description
31:15	reserved	RO	0x00	Software should not rely on the value of a reserved bit. To provide compatibility with future products, the value of a reserved bit should be preserved across a read-modify-write operation.
14:12	MUX3	R/W	0	4th Sample Input Select
11	reserved	RO	0	Software should not rely on the value of a reserved bit. To provide compatibility with future products, the value of a reserved bit should be preserved across a read-modify-write operation.
10:8	MUX2	R/W	0	3rd Sample Input Select
7	reserved	RO	0	Software should not rely on the value of a reserved bit. To provide compatibility with future products, the value of a reserved bit should be preserved across a read-modify-write operation.
6:4	MUX1	R/W	0	2nd Sample Input Select
3	reserved	RO	0	Software should not rely on the value of a reserved bit. To provide compatibility with future products, the value of a reserved bit should be preserved across a read-modify-write operation.
2:0	MUX0	R/W	0	1st Sample Input Select

Register 23: ADC Sample Sequence Control 1 (ADCSSCTL1), offset 0x064

Register 24: ADC Sample Sequence Control 2 (ADCSSCTL2), offset 0x084

These registers contain the configuration information for each sample for a sequence executed with Sample Sequencer 1 or 2. When configuring a sample sequence, the **END** bit must be set at some point, whether it be after the first sample, last sample, or any sample in between. This register is 16-bits wide and contains information for four possible samples. See the **ADCSSCTL0** register on page 244 for detailed bit descriptions.

ADC Sample Sequence Control 1 (ADCSSCTL1)

Base 0x4003.8000
 Offset 0x064
 Type R/W, reset 0x0000.0000

	31	30	29	28	27	26	25	24	23	22	21	20	19	18	17	16
	reserved															
Type	RO	RO	RO	RO	RO	RO	RO	RO	RO	RO	RO	RO	RO	RO	RO	RO
Reset	0	0	0	0	0	0	0	0	0	0	0	0	0	0	0	0
	15	14	13	12	11	10	9	8	7	6	5	4	3	2	1	0
	TS3	IE3	END3	D3	TS2	IE2	END2	D2	TS1	IE1	END1	D1	TS0	IE0	END0	D0
Type	R/W	R/W	R/W	R/W	R/W	R/W	R/W	R/W	R/W	R/W	R/W	R/W	R/W	R/W	R/W	R/W
Reset	0	0	0	0	0	0	0	0	0	0	0	0	0	0	0	0

Bit/Field	Name	Type	Reset	Description
31:16	reserved	RO	0x00	Software should not rely on the value of a reserved bit. To provide compatibility with future products, the value of a reserved bit should be preserved across a read-modify-write operation.
15	TS3	R/W	0	4th Sample Temp Sensor Select Same definition as TS7 but used during the fourth sample.
14	IE3	R/W	0	4th Sample Interrupt Enable Same definition as IE7 but used during the fourth sample.
13	END3	R/W	0	4th Sample is End of Sequence Same definition as END7 but used during the fourth sample.
12	D3	R/W	0	4th Sample Diff Input Select Same definition as D7 but used during the fourth sample.
11	TS2	R/W	0	3rd Sample Temp Sensor Select Same definition as TS7 but used during the third sample.
10	IE2	R/W	0	3rd Sample Interrupt Enable Same definition as IE7 but used during the third sample.
9	END2	R/W	0	3rd Sample is End of Sequence Same definition as END7 but used during the third sample.
8	D2	R/W	0	3rd Sample Diff Input Select Same definition as D7 but used during the third sample.

Bit/Field	Name	Type	Reset	Description
7	TS1	R/W	0	2nd Sample Temp Sensor Select Same definition as TS7 but used during the second sample.
6	IE1	R/W	0	2nd Sample Interrupt Enable Same definition as IE7 but used during the second sample.
5	END1	R/W	0	2nd Sample is End of Sequence Same definition as END7 but used during the second sample.
4	D1	R/W	0	2nd Sample Diff Input Select Same definition as D7 but used during the second sample.
3	TS0	R/W	0	1st Sample Temp Sensor Select Same definition as TS7 but used during the first sample.
2	IE0	R/W	0	1st Sample Interrupt Enable Same definition as IE7 but used during the first sample.
1	END0	R/W	0	1st Sample is End of Sequence Same definition as END7 but used during the first sample. Since this sequencer has only one entry, this bit must be set.
0	D0	R/W	0	1st Sample Diff Input Select Same definition as D7 but used during the first sample.

Register 25: ADC Sample Sequence Input Multiplexer Select 3 (ADCSSMUX3), offset 0x0A0

This register defines the analog input configuration for each sample in a sequence executed with Sample Sequencer 3. This register is 4-bits wide and contains information for one possible sample. See the **ADCSSMUX0** register on page 242 for detailed bit descriptions.

ADC Sample Sequence Input Multiplexer Select 3 (ADCSSMUX3)

Base 0x4003.8000
 Offset 0x0A0
 Type R/W, reset 0x0000.0000

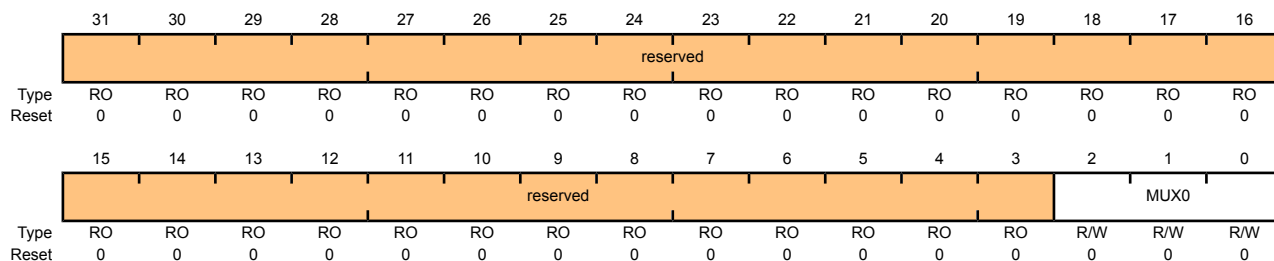

Bit/Field	Name	Type	Reset	Description
31:3	reserved	RO	0x00	Software should not rely on the value of a reserved bit. To provide compatibility with future products, the value of a reserved bit should be preserved across a read-modify-write operation.
2:0	MUX0	R/W	0	1st Sample Input Select

Register 26: ADC Sample Sequence Control 3 (ADCSSCTL3), offset 0x0A4

This register contains the configuration information for each sample for a sequence executed with Sample Sequencer 3. The `END` bit is always set since there is only one sample in this sequencer. This register is 4-bits wide and contains information for one possible sample. See the `ADCSSCTL0` register on page 244 for detailed bit descriptions.

ADC Sample Sequence Control 3 (ADCSSCTL3)

Base 0x4003.8000
Offset 0x0A4
Type R/W, reset 0x0000.0002

	31	30	29	28	27	26	25	24	23	22	21	20	19	18	17	16
	reserved															
Type	RO	RO	RO	RO	RO	RO	RO	RO	RO	RO	RO	RO	RO	RO	RO	RO
Reset	0	0	0	0	0	0	0	0	0	0	0	0	0	0	0	0
	15	14	13	12	11	10	9	8	7	6	5	4	3	2	1	0
	reserved												TS0	IE0	END0	D0
Type	RO	RO	RO	RO	RO	RO	RO	RO	RO	RO	RO	RO	R/W	R/W	R/W	R/W
Reset	0	0	0	0	0	0	0	0	0	0	0	0	0	0	1	0

Bit/Field	Name	Type	Reset	Description
31:4	reserved	RO	0x00	Software should not rely on the value of a reserved bit. To provide compatibility with future products, the value of a reserved bit should be preserved across a read-modify-write operation.
3	TS0	R/W	0	1st Sample Temp Sensor Select Same definition as <code>TS7</code> but used during the first sample.
2	IE0	R/W	0	1st Sample Interrupt Enable Same definition as <code>IE7</code> but used during the first sample.
1	END0	R/W	1	1st Sample is End of Sequence Same definition as <code>END7</code> but used during the first sample. Since this sequencer has only one entry, this bit must be set.
0	D0	R/W	0	1st Sample Diff Input Select Same definition as <code>D7</code> but used during the first sample.

Register 27: ADC Test Mode Loopback (ADCTMLB), offset 0x100

This register provides loopback operation within the digital logic of the ADC, which can be useful in debugging software without having to provide actual analog stimulus. This test mode is entered by writing a value of 0x0000.0001 to this register. When data is read from the FIFO in loopback mode, the read-only portion of this register is returned.

ADC Test Mode Loopback (ADCTMLB)

Base 0x4003.8000
 Offset 0x100
 Type R/W, reset 0x0000.0000

	31	30	29	28	27	26	25	24	23	22	21	20	19	18	17	16
	reserved															
Type	RO	RO	RO	RO	RO	RO	RO	RO	RO	RO	RO	RO	RO	RO	RO	RO
Reset	0	0	0	0	0	0	0	0	0	0	0	0	0	0	0	0
	15	14	13	12	11	10	9	8	7	6	5	4	3	2	1	0
	reserved															LB
Type	RO	RO	RO	RO	RO	RO	RO	RO	RO	RO	RO	RO	RO	RO	RO	R/W
Reset	0	0	0	0	0	0	0	0	0	0	0	0	0	0	0	0

Bit/Field	Name	Type	Reset	Description
31:1	reserved	RO	0x00	Software should not rely on the value of a reserved bit. To provide compatibility with future products, the value of a reserved bit should be preserved across a read-modify-write operation.
0	LB	R/W	0	Loopback Mode Enable

When set, forces a loopback within the digital block to provide information on input and unique numbering. The **ADCSSFIFO**n registers do not provide sample data, but instead provide the 10-bit loopback data as shown below.

Bit/Field	Name	Description
9:6	CNT	Continuous Sample Counter Continuous sample counter that is initialized to 0 and counts each sample as it processed. This helps provide a unique value for the data received.
5	CONT	Continuation Sample Indicator When set, indicates that this is a continuation sample. For example, if two sequencers were to run back-to-back, this indicates that the controller kept continuously sampling at full rate.
4	DIFF	Differential Sample Indicator When set, indicates that this is a differential sample.
3	TS	Temp Sensor Sample Indicator When set, indicates that this is a temperature sensor sample.
2:0	MUX	Analog Input Indicator Indicates which analog input is to be sampled.

12 Universal Asynchronous Receivers/Transmitters (UARTs)

The Stellaris[®] Universal Asynchronous Receiver/Transmitter (UART) provides fully programmable, 16C550-type serial interface characteristics. The LM3S828 controller is equipped with two UART modules.

Each UART has the following features:

- Separate transmit and receive FIFOs
- Programmable FIFO length, including 1-byte deep operation providing conventional double-buffered interface
- FIFO trigger levels of 1/8, 1/4, 1/2, 3/4, and 7/8
- Programmable baud-rate generator allowing rates up to 3.125 Mbps
- Standard asynchronous communication bits for start, stop, and parity
- False start bit detection
- Line-break generation and detection
- Fully programmable serial interface characteristics:
 - 5, 6, 7, or 8 data bits
 - Even, odd, stick, or no-parity bit generation/detection
 - 1 or 2 stop bit generation

12.1 Block Diagram

Figure 12-1. UART Module Block Diagram

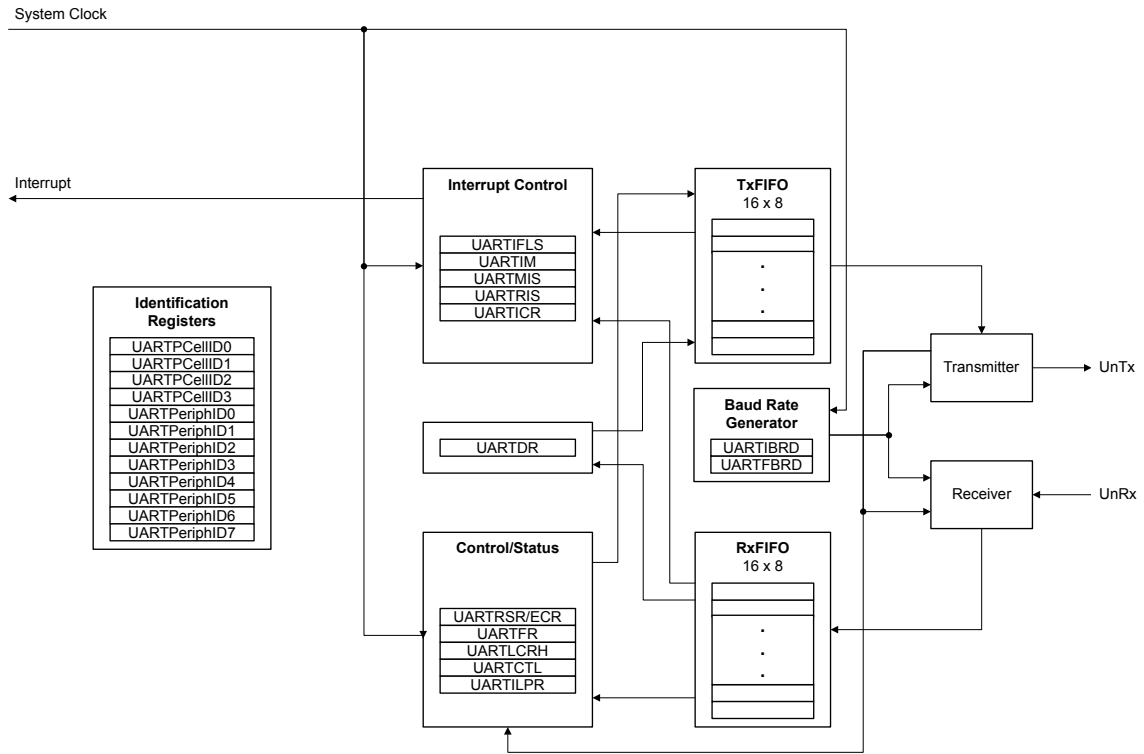

12.2 Functional Description

Each Stellaris[®] UART performs the functions of parallel-to-serial and serial-to-parallel conversions. It is similar in functionality to a 16C550 UART, but is not register compatible.

The UART is configured for transmit and/or receive via the TXE and RXE bits of the **UART Control (UARTCTL)** register (see page 272). Transmit and receive are both enabled out of reset. Before any control registers are programmed, the UART must be disabled by clearing the UARTEEN bit in **UARTCTL**. If the UART is disabled during a TX or RX operation, the current transaction is completed prior to the UART stopping.

12.2.1 Transmit/Receive Logic

The transmit logic performs parallel-to-serial conversion on the data read from the transmit FIFO. The control logic outputs the serial bit stream beginning with a start bit, and followed by the data bits (LSB first), parity bit, and the stop bits according to the programmed configuration in the control registers. See Figure 12-2 on page 257 for details.

The receive logic performs serial-to-parallel conversion on the received bit stream after a valid start pulse has been detected. Overrun, parity, frame error checking, and line-break detection are also performed, and their status accompanies the data that is written to the receive FIFO.

Figure 12-2. UART Character Frame

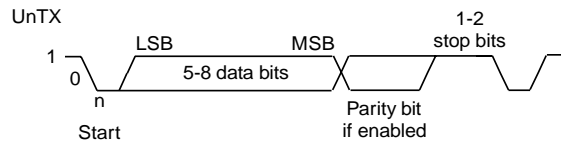

12.2.2 Baud-Rate Generation

The baud-rate divisor is a 22-bit number consisting of a 16-bit integer and a 6-bit fractional part. The number formed by these two values is used by the baud-rate generator to determine the bit period. Having a fractional baud-rate divider allows the UART to generate all the standard baud rates.

The 16-bit integer is loaded through the **UART Integer Baud-Rate Divisor (UARTIBRD)** register (see page 268) and the 6-bit fractional part is loaded with the **UART Fractional Baud-Rate Divisor (UARTFBRD)** register (see page 269). The baud-rate divisor (BRD) has the following relationship to the system clock (where *BRDI* is the integer part of the BRD and *BRDF* is the fractional part, separated by a decimal place.)

$$BRD = BRDI + BRDF = \text{UARTSysClk} / (16 * \text{Baud Rate})$$

where *UARTSysClk* is the system clock connected to the UART.

The 6-bit fractional number (that is to be loaded into the *DIVFRAC* bit field in the **UARTFBRD** register) can be calculated by taking the fractional part of the baud-rate divisor, multiplying it by 64, and adding 0.5 to account for rounding errors:

$$\text{UARTFBRD}[\text{DIVFRAC}] = \text{integer}(\text{BRDF} * 64 + 0.5)$$

The UART generates an internal baud-rate reference clock at 16x the baud-rate (referred to as *Baud16*). This reference clock is divided by 16 to generate the transmit clock, and is used for error detection during receive operations.

Along with the **UART Line Control, High Byte (UARTLCRH)** register (see page 270), the **UARTIBRD** and **UARTFBRD** registers form an internal 30-bit register. This internal register is only updated when a write operation to **UARTLCRH** is performed, so any changes to the baud-rate divisor must be followed by a write to the **UARTLCRH** register for the changes to take effect.

To update the baud-rate registers, there are four possible sequences:

- **UARTIBRD** write, **UARTFBRD** write, and **UARTLCRH** write
- **UARTFBRD** write, **UARTIBRD** write, and **UARTLCRH** write
- **UARTIBRD** write and **UARTLCRH** write
- **UARTFBRD** write and **UARTLCRH** write

12.2.3 Data Transmission

Data received or transmitted is stored in two 16-byte FIFOs, though the receive FIFO has an extra four bits per character for status information. For transmission, data is written into the transmit FIFO. If the UART is enabled, it causes a data frame to start transmitting with the parameters indicated in the **UARTLCRH** register. Data continues to be transmitted until there is no data left in the transmit

FIFO. The `BUSY` bit in the **UART Flag (UARTFR)** register (see page 266) is asserted as soon as data is written to the transmit FIFO (that is, if the FIFO is non-empty) and remains asserted while data is being transmitted. The `BUSY` bit is negated only when the transmit FIFO is empty, and the last character has been transmitted from the shift register, including the stop bits. The UART can indicate that it is busy even though the UART may no longer be enabled.

When the receiver is idle (the `UnRx` is continuously 1) and the data input goes Low (a start bit has been received), the receive counter begins running and data is sampled on the eighth cycle of `Baud16` (described in “Transmit/Receive Logic” on page 256).

The start bit is valid if `UnRx` is still low on the eighth cycle of `Baud16`, otherwise a false start bit is detected and it is ignored. Start bit errors can be viewed in the **UART Receive Status (UARTRSR)** register (see page 264). If the start bit was valid, successive data bits are sampled on every 16th cycle of `Baud16` (that is, one bit period later) according to the programmed length of the data characters. The parity bit is then checked if parity mode was enabled. Data length and parity are defined in the **UARTLCRH** register.

Lastly, a valid stop bit is confirmed if `UnRx` is High, otherwise a framing error has occurred. When a full word is received, the data is stored in the receive FIFO, with any error bits associated with that word.

12.2.4 FIFO Operation

The UART has two 16-entry FIFOs; one for transmit and one for receive. Both FIFOs are accessed via the **UART Data (UARTDR)** register (see page 262). Read operations of the **UARTDR** register return a 12-bit value consisting of 8 data bits and 4 error flags while write operations place 8-bit data in the transmit FIFO.

Out of reset, both FIFOs are disabled and act as 1-byte-deep holding registers. The FIFOs are enabled by setting the `FEN` bit in **UARTLCRH** (page 270).

FIFO status can be monitored via the **UART Flag (UARTFR)** register (see page 266) and the **UART Receive Status (UARTRSR)** register. Hardware monitors empty, full and overrun conditions. The **UARTFR** register contains empty and full flags (`TXFE`, `TXFF`, `RXFE`, and `RXFF` bits) and the **UARTRSR** register shows overrun status via the `OE` bit.

The trigger points at which the FIFOs generate interrupts is controlled via the **UART Interrupt FIFO Level Select (UARTIFLS)** register (see page 274). Both FIFOs can be individually configured to trigger interrupts at different levels. Available configurations include $1/8$, $1/4$, $1/2$, $3/4$, and $7/8$. For example, if the $1/4$ option is selected for the receive FIFO, the UART generates a receive interrupt after 4 data bytes are received. Out of reset, both FIFOs are configured to trigger an interrupt at the $1/2$ mark.

12.2.5 Interrupts

The UART can generate interrupts when the following conditions are observed:

- Overrun Error
- Break Error
- Parity Error
- Framing Error
- Receive Timeout

- Transmit (when condition defined in the `TXIFLSEL` bit in the **UARTIFLS** register is met)
- Receive (when condition defined in the `RXIFLSEL` bit in the **UARTIFLS** register is met)

All of the interrupt events are ORed together before being sent to the interrupt controller, so the UART can only generate a single interrupt request to the controller at any given time. Software can service multiple interrupt events in a single interrupt service routine by reading the **UART Masked Interrupt Status (UARTMIS)** register (see page 279).

The interrupt events that can trigger a controller-level interrupt are defined in the **UART Interrupt Mask (UARTIM)** register (see page 276) by setting the corresponding `IM` bit to 1. If interrupts are not used, the raw interrupt status is always visible via the **UART Raw Interrupt Status (UARTRIS)** register (see page 278).

Interrupts are always cleared (for both the **UARTMIS** and **UARTRIS** registers) by setting the corresponding bit in the **UART Interrupt Clear (UARTICR)** register (see page 280).

The receive timeout interrupt is asserted when the receive FIFO is not empty, and no further data is received over a 32-bit period. The receive timeout interrupt is cleared either when the FIFO becomes empty through reading all the data (or by reading the holding register), or when a 1 is written to the corresponding bit in the **UARTICR** register.

12.2.6 Loopback Operation

The UART can be placed into an internal loopback mode for diagnostic or debug work. This is accomplished by setting the `LBE` bit in the **UARTCTL** register (see page 272). In loopback mode, data transmitted on UnTx is received on the UnRx input.

12.3 Initialization and Configuration

To use the UARTs, the peripheral clock must be enabled by setting the `UART0` or `UART1` bits in the **RCGC1** register.

This section discusses the steps that are required to use a UART module. For this example, the UART clock is assumed to be 20 MHz and the desired UART configuration is:

- 115200 baud rate
- Data length of 8 bits
- One stop bit
- No parity
- FIFOs disabled
- No interrupts

The first thing to consider when programming the UART is the baud-rate divisor (BRD), since the **UARTIBRD** and **UARTFBRD** registers must be written before the **UARTLCRH** register. Using the equation described in “Baud-Rate Generation” on page 257, the BRD can be calculated:

$$\text{BRD} = 20,000,000 / (16 * 115,200) = 10.8507$$

which means that the `DIVINT` field of the **UARTIBRD** register (see page 268) should be set to 10. The value to be loaded into the **UARTFBRD** register (see page 269) is calculated by the equation:

$$\text{UARTFBRD}[\text{DIVFRAC}] = \text{integer}(0.8507 * 64 + 0.5) = 54$$

With the BRD values in hand, the UART configuration is written to the module in the following order:

1. Disable the UART by clearing the `UARTEN` bit in the `UARTCTL` register.
2. Write the integer portion of the BRD to the `UARTIBRD` register.
3. Write the fractional portion of the BRD to the `UARTFBRD` register.
4. Write the desired serial parameters to the `UARTLCRH` register (in this case, a value of `0x0000.0060`).
5. Enable the UART by setting the `UARTEN` bit in the `UARTCTL` register.

12.4 Register Map

Table 12-1 on page 260 lists the UART registers. The offset listed is a hexadecimal increment to the register's address, relative to that UART's base address:

- UART0: `0x4000.C000`
- UART1: `0x4000.D000`

Note: The UART must be disabled (see the `UARTEN` bit in the `UARTCTL` register on page 272) before any of the control registers are reprogrammed. When the UART is disabled during a TX or RX operation, the current transaction is completed prior to the UART stopping.

Table 12-1. UART Register Map

Offset	Name	Type	Reset	Description	See page
0x000	UARTDR	R/W	0x0000.0000	UART Data	262
0x004	UARTSR/UARTECR	R/W	0x0000.0000	UART Receive Status/Error Clear	264
0x018	UARTFR	RO	0x0000.0090	UART Flag	266
0x024	UARTIBRD	R/W	0x0000.0000	UART Integer Baud-Rate Divisor	268
0x028	UARTFBRD	R/W	0x0000.0000	UART Fractional Baud-Rate Divisor	269
0x02C	UARTLCRH	R/W	0x0000.0000	UART Line Control	270
0x030	UARTCTL	R/W	0x0000.0300	UART Control	272
0x034	UARTIFLS	R/W	0x0000.0012	UART Interrupt FIFO Level Select	274
0x038	UARTIM	R/W	0x0000.0000	UART Interrupt Mask	276
0x03C	UARTRIS	RO	0x0000.000F	UART Raw Interrupt Status	278
0x040	UARTMIS	RO	0x0000.0000	UART Masked Interrupt Status	279
0x044	UARTICR	W1C	0x0000.0000	UART Interrupt Clear	280
0xFD0	UARTPeriphID4	RO	0x0000.0000	UART Peripheral Identification 4	282
0xFD4	UARTPeriphID5	RO	0x0000.0000	UART Peripheral Identification 5	283
0xFD8	UARTPeriphID6	RO	0x0000.0000	UART Peripheral Identification 6	284

Offset	Name	Type	Reset	Description	See page
0xFDC	UARTPeriphID7	RO	0x0000.0000	UART Peripheral Identification 7	285
0xFE0	UARTPeriphID0	RO	0x0000.0011	UART Peripheral Identification 0	286
0xFE4	UARTPeriphID1	RO	0x0000.0000	UART Peripheral Identification 1	287
0xFE8	UARTPeriphID2	RO	0x0000.0018	UART Peripheral Identification 2	288
0xFEC	UARTPeriphID3	RO	0x0000.0001	UART Peripheral Identification 3	289
0xFF0	UARTPCellID0	RO	0x0000.000D	UART PrimeCell Identification 0	290
0xFF4	UARTPCellID1	RO	0x0000.00F0	UART PrimeCell Identification 1	291
0xFF8	UARTPCellID2	RO	0x0000.0005	UART PrimeCell Identification 2	292
0xFFC	UARTPCellID3	RO	0x0000.00B1	UART PrimeCell Identification 3	293

12.5 Register Descriptions

The remainder of this section lists and describes the UART registers, in numerical order by address offset.

Register 1: UART Data (UARTDR), offset 0x000

This register is the data register (the interface to the FIFOs).

When FIFOs are enabled, data written to this location is pushed onto the transmit FIFO. If FIFOs are disabled, data is stored in the transmitter holding register (the bottom word of the transmit FIFO). A write to this register initiates a transmission from the UART.

For received data, if the FIFO is enabled, the data byte and the 4-bit status (break, frame, parity, and overrun) is pushed onto the 12-bit wide receive FIFO. If FIFOs are disabled, the data byte and status are stored in the receiving holding register (the bottom word of the receive FIFO). The received data can be retrieved by reading this register.

UART Data (UARTDR)

UART0 base: 0x4000.C000
 UART1 base: 0x4000.D000
 Offset 0x000
 Type R/W, reset 0x0000.0000

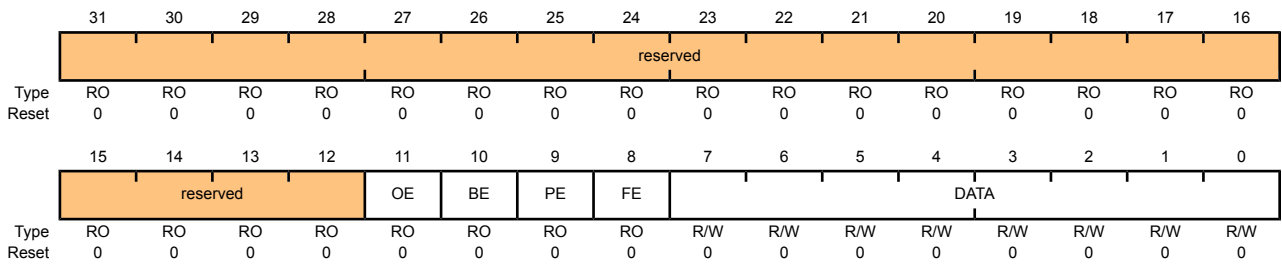

Bit/Field	Name	Type	Reset	Description
31:12	reserved	RO	0	Software should not rely on the value of a reserved bit. To provide compatibility with future products, the value of a reserved bit should be preserved across a read-modify-write operation.
11	OE	RO	0	UART Overrun Error The OE values are defined as follows: Value Description 0 There has been no data loss due to a FIFO overrun. 1 New data was received when the FIFO was full, resulting in data loss.
10	BE	RO	0	UART Break Error This bit is set to 1 when a break condition is detected, indicating that the receive data input was held Low for longer than a full-word transmission time (defined as start, data, parity, and stop bits). In FIFO mode, this error is associated with the character at the top of the FIFO. When a break occurs, only one 0 character is loaded into the FIFO. The next character is only enabled after the received data input goes to a 1 (marking state) and the next valid start bit is received.

Bit/Field	Name	Type	Reset	Description
9	PE	RO	0	UART Parity Error This bit is set to 1 when the parity of the received data character does not match the parity defined by bits 2 and 7 of the UARTLCRH register. In FIFO mode, this error is associated with the character at the top of the FIFO.
8	FE	RO	0	UART Framing Error This bit is set to 1 when the received character does not have a valid stop bit (a valid stop bit is 1).
7:0	DATA	R/W	0	Data Transmitted or Received When written, the data that is to be transmitted via the UART. When read, the data that was received by the UART.

Register 2: UART Receive Status/Error Clear (UARTRSR/UARTECR), offset 0x004

The **UARTRSR/UARTECR** register is the receive status register/error clear register.

In addition to the **UARTDR** register, receive status can also be read from the **UARTRSR** register. If the status is read from this register, then the status information corresponds to the entry read from **UARTDR** prior to reading **UARTRSR**. The status information for overrun is set immediately when an overrun condition occurs.

The **UARTRSR** register cannot be written.

A write of any value to the **UARTECR** register clears the framing, parity, break, and overrun errors. All the bits are cleared to 0 on reset.

Read-Only Receive Status (UARTRSR) Register

UART Receive Status/Error Clear (UARTRSR/UARTECR)

UART0 base: 0x4000.C000

UART1 base: 0x4000.D000

Offset 0x004

Type RO, reset 0x0000.0000

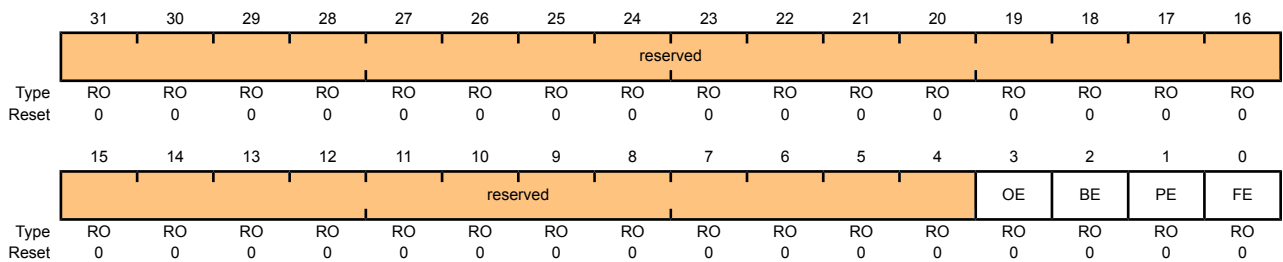

Bit/Field	Name	Type	Reset	Description
31:4	reserved	RO	0	Software should not rely on the value of a reserved bit. To provide compatibility with future products, the value of a reserved bit should be preserved across a read-modify-write operation.
3	OE	RO	0	<p>UART Overrun Error</p> <p>When this bit is set to 1, data is received and the FIFO is already full. This bit is cleared to 0 by a write to UARTECR.</p> <p>The FIFO contents remain valid since no further data is written when the FIFO is full, only the contents of the shift register are overwritten. The CPU must now read the data in order to empty the FIFO.</p>
2	BE	RO	0	<p>UART Break Error</p> <p>This bit is set to 1 when a break condition is detected, indicating that the received data input was held Low for longer than a full-word transmission time (defined as start, data, parity, and stop bits).</p> <p>This bit is cleared to 0 by a write to UARTECR.</p> <p>In FIFO mode, this error is associated with the character at the top of the FIFO. When a break occurs, only one 0 character is loaded into the FIFO. The next character is only enabled after the receive data input goes to a 1 (marking state) and the next valid start bit is received.</p>

Bit/Field	Name	Type	Reset	Description
1	PE	RO	0	<p>UART Parity Error</p> <p>This bit is set to 1 when the parity of the received data character does not match the parity defined by bits 2 and 7 of the UARTLCRH register.</p> <p>This bit is cleared to 0 by a write to UARTECR.</p>
0	FE	RO	0	<p>UART Framing Error</p> <p>This bit is set to 1 when the received character does not have a valid stop bit (a valid stop bit is 1).</p> <p>This bit is cleared to 0 by a write to UARTECR.</p> <p>In FIFO mode, this error is associated with the character at the top of the FIFO.</p>

Write-Only Error Clear (UARTECR) Register

UART Receive Status/Error Clear (UARTRSR/UARTECR)

UART0 base: 0x4000.C000
 UART1 base: 0x4000.D000
 Offset 0x004
 Type WO, reset 0x0000.0000

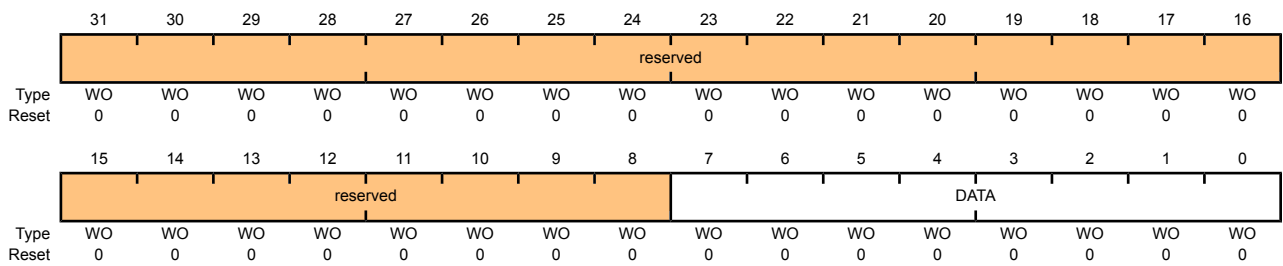

Bit/Field	Name	Type	Reset	Description
31:8	reserved	WO	0	<p>Software should not rely on the value of a reserved bit. To provide compatibility with future products, the value of a reserved bit should be preserved across a read-modify-write operation.</p>
7:0	DATA	WO	0	<p>Error Clear</p> <p>A write to this register of any data clears the framing, parity, break, and overrun flags.</p>

Register 3: UART Flag (UARTFR), offset 0x018

The **UARTFR** register is the flag register. After reset, the **TXFF**, **RXFF**, and **BUSY** bits are 0, and **TXFE** and **RXFE** bits are 1.

UART Flag (UARTFR)

UART0 base: 0x4000.C000
 UART1 base: 0x4000.D000
 Offset 0x018
 Type RO, reset 0x0000.0090

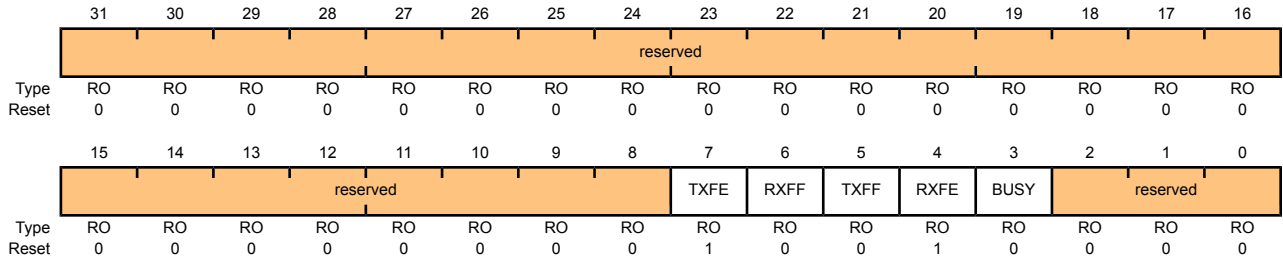

Bit/Field	Name	Type	Reset	Description
31:8	reserved	RO	0	Software should not rely on the value of a reserved bit. To provide compatibility with future products, the value of a reserved bit should be preserved across a read-modify-write operation.
7	TXFE	RO	1	UART Transmit FIFO Empty The meaning of this bit depends on the state of the FEN bit in the UARTLCRH register. If the FIFO is disabled (FEN is 0), this bit is set when the transmit holding register is empty. If the FIFO is enabled (FEN is 1), this bit is set when the transmit FIFO is empty.
6	RXFF	RO	0	UART Receive FIFO Full The meaning of this bit depends on the state of the FEN bit in the UARTLCRH register. If the FIFO is disabled, this bit is set when the receive holding register is full. If the FIFO is enabled, this bit is set when the receive FIFO is full.
5	TXFF	RO	0	UART Transmit FIFO Full The meaning of this bit depends on the state of the FEN bit in the UARTLCRH register. If the FIFO is disabled, this bit is set when the transmit holding register is full. If the FIFO is enabled, this bit is set when the transmit FIFO is full.

Bit/Field	Name	Type	Reset	Description
4	RXFE	RO	1	UART Receive FIFO Empty The meaning of this bit depends on the state of the <code>FEN</code> bit in the <code>UARTLCRH</code> register. If the FIFO is disabled, this bit is set when the receive holding register is empty. If the FIFO is enabled, this bit is set when the receive FIFO is empty.
3	BUSY	RO	0	UART Busy When this bit is 1, the UART is busy transmitting data. This bit remains set until the complete byte, including all stop bits, has been sent from the shift register. This bit is set as soon as the transmit FIFO becomes non-empty (regardless of whether UART is enabled).
2:0	reserved	RO	0	Software should not rely on the value of a reserved bit. To provide compatibility with future products, the value of a reserved bit should be preserved across a read-modify-write operation.

Register 4: UART Integer Baud-Rate Divisor (UARTIBRD), offset 0x024

The **UARTIBRD** register is the integer part of the baud-rate divisor value. All the bits are cleared on reset. The minimum possible divide ratio is 1 (when **UARTIBRD**=0), in which case the **UARTFBRD** register is ignored. When changing the **UARTIBRD** register, the new value does not take effect until transmission/reception of the current character is complete. Any changes to the baud-rate divisor must be followed by a write to the **UARTLCRH** register. See “Baud-Rate Generation” on page 257 for configuration details.

UART Integer Baud-Rate Divisor (UARTIBRD)

UART0 base: 0x4000.C000
 UART1 base: 0x4000.D000
 Offset 0x024
 Type R/W, reset 0x0000.0000

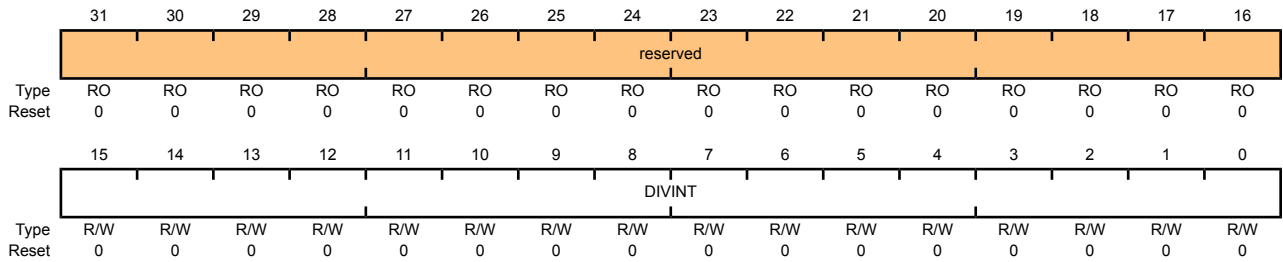

Bit/Field	Name	Type	Reset	Description
31:16	reserved	RO	0	Software should not rely on the value of a reserved bit. To provide compatibility with future products, the value of a reserved bit should be preserved across a read-modify-write operation.
15:0	DIVINT	R/W	0x0000	Integer Baud-Rate Divisor

Register 5: UART Fractional Baud-Rate Divisor (UARTFBRD), offset 0x028

The **UARTFBRD** register is the fractional part of the baud-rate divisor value. All the bits are cleared on reset. When changing the **UARTFBRD** register, the new value does not take effect until transmission/reception of the current character is complete. Any changes to the baud-rate divisor must be followed by a write to the **UARTLCRH** register. See “Baud-Rate Generation” on page 257 for configuration details.

UART Fractional Baud-Rate Divisor (UARTFBRD)

UART0 base: 0x4000.C000
 UART1 base: 0x4000.D000
 Offset 0x028
 Type R/W, reset 0x0000.0000

	31	30	29	28	27	26	25	24	23	22	21	20	19	18	17	16
	reserved															
Type	RO	RO	RO	RO	RO	RO	RO	RO	RO	RO	RO	RO	RO	RO	RO	RO
Reset	0	0	0	0	0	0	0	0	0	0	0	0	0	0	0	0
	15	14	13	12	11	10	9	8	7	6	5	4	3	2	1	0
	reserved										DIVFRAC					
Type	RO	RO	RO	RO	RO	RO	RO	RO	RO	RO	R/W	R/W	R/W	R/W	R/W	R/W
Reset	0	0	0	0	0	0	0	0	0	0	0	0	0	0	0	0

Bit/Field	Name	Type	Reset	Description
31:6	reserved	RO	0x00	Software should not rely on the value of a reserved bit. To provide compatibility with future products, the value of a reserved bit should be preserved across a read-modify-write operation.
5:0	DIVFRAC	R/W	0x000	Fractional Baud-Rate Divisor

Register 6: UART Line Control (UARTLCRH), offset 0x02C

The **UARTLCRH** register is the line control register. Serial parameters such as data length, parity, and stop bit selection are implemented in this register.

When updating the baud-rate divisor (**UARTIBRD** and/or **UARTIFRD**), the **UARTLCRH** register must also be written. The write strobe for the baud-rate divisor registers is tied to the **UARTLCRH** register.

UART Line Control (UARTLCRH)

UART0 base: 0x4000.C000
 UART1 base: 0x4000.D000
 Offset 0x02C
 Type R/W, reset 0x0000.0000

	31	30	29	28	27	26	25	24	23	22	21	20	19	18	17	16
	reserved															
Type	RO	RO	RO	RO	RO	RO	RO	RO	RO	RO	RO	RO	RO	RO	RO	RO
Reset	0	0	0	0	0	0	0	0	0	0	0	0	0	0	0	0
	15	14	13	12	11	10	9	8	7	6	5	4	3	2	1	0
	reserved								SPS	WLEN		FEN	STP2	EPS	PEN	BRK
Type	RO	RO	RO	RO	RO	RO	RO	RO	R/W	R/W	R/W	R/W	R/W	R/W	R/W	R/W
Reset	0	0	0	0	0	0	0	0	0	0	0	0	0	0	0	0

Bit/Field	Name	Type	Reset	Description										
31:8	reserved	RO	0	Software should not rely on the value of a reserved bit. To provide compatibility with future products, the value of a reserved bit should be preserved across a read-modify-write operation.										
7	SPS	R/W	0	UART Stick Parity Select When bits 1, 2, and 7 of UARTLCRH are set, the parity bit is transmitted and checked as a 0. When bits 1 and 7 are set and 2 is cleared, the parity bit is transmitted and checked as a 1. When this bit is cleared, stick parity is disabled.										
6:5	WLEN	R/W	0	UART Word Length The bits indicate the number of data bits transmitted or received in a frame as follows: <table border="1"> <thead> <tr> <th>Value</th> <th>Description</th> </tr> </thead> <tbody> <tr> <td>0x3</td> <td>8 bits</td> </tr> <tr> <td>0x2</td> <td>7 bits</td> </tr> <tr> <td>0x1</td> <td>6 bits</td> </tr> <tr> <td>0x0</td> <td>5 bits (default)</td> </tr> </tbody> </table>	Value	Description	0x3	8 bits	0x2	7 bits	0x1	6 bits	0x0	5 bits (default)
Value	Description													
0x3	8 bits													
0x2	7 bits													
0x1	6 bits													
0x0	5 bits (default)													
4	FEN	R/W	0	UART Enable FIFOs If this bit is set to 1, transmit and receive FIFO buffers are enabled (FIFO mode). When cleared to 0, FIFOs are disabled (Character mode). The FIFOs become 1-byte-deep holding registers.										

Bit/Field	Name	Type	Reset	Description
3	STP2	R/W	0	<p>UART Two Stop Bits Select</p> <p>If this bit is set to 1, two stop bits are transmitted at the end of a frame. The receive logic does not check for two stop bits being received.</p>
2	EPS	R/W	0	<p>UART Even Parity Select</p> <p>If this bit is set to 1, even parity generation and checking is performed during transmission and reception, which checks for an even number of 1s in data and parity bits.</p> <p>When cleared to 0, then odd parity is performed, which checks for an odd number of 1s.</p> <p>This bit has no effect when parity is disabled by the <code>PEN</code> bit.</p>
1	PEN	R/W	0	<p>UART Parity Enable</p> <p>If this bit is set to 1, parity checking and generation is enabled; otherwise, parity is disabled and no parity bit is added to the data frame.</p>
0	BRK	R/W	0	<p>UART Send Break</p> <p>If this bit is set to 1, a Low level is continually output on the <code>U_nTX</code> output, after completing transmission of the current character. For the proper execution of the break command, the software must set this bit for at least two frames (character periods). For normal use, this bit must be cleared to 0.</p>

Register 7: UART Control (UARTCTL), offset 0x030

The **UARTCTL** register is the control register. All the bits are cleared on reset except for the Transmit Enable (TXE) and Receive Enable (RXE) bits, which are set to 1.

To enable the UART module, the **UARTEN** bit must be set to 1. If software requires a configuration change in the module, the **UARTEN** bit must be cleared before the configuration changes are written. If the UART is disabled during a transmit or receive operation, the current transaction is completed prior to the UART stopping.

Note: The **UARTCTL** register should not be changed while the UART is enabled or else the results are unpredictable. The following sequence is recommended for making changes to the **UARTCTL** register.

1. Disable the UART.
2. Wait for the end of transmission or reception of the current character.
3. Flush the transmit FIFO by disabling bit 4 (**FEN**) in the line control register (**UARTLCRH**).
4. Reprogram the control register.
5. Enable the UART.

UART Control (UARTCTL)

UART0 base: 0x4000.C000
 UART1 base: 0x4000.D000
 Offset 0x030
 Type R/W, reset 0x0000.0300

	31	30	29	28	27	26	25	24	23	22	21	20	19	18	17	16
	reserved															
Type	RO	RO	RO	RO	RO	RO	RO	RO	RO	RO	RO	RO	RO	RO	RO	RO
Reset	0	0	0	0	0	0	0	0	0	0	0	0	0	0	0	0
	15	14	13	12	11	10	9	8	7	6	5	4	3	2	1	0
	reserved						RXE	TXE	LBE	reserved						UARTEN
Type	RO	RO	RO	RO	RO	RO	R/W	R/W	R/W	RO	RO	RO	RO	RO	RO	R/W
Reset	0	0	0	0	0	0	1	1	0	0	0	0	0	0	0	0

Bit/Field	Name	Type	Reset	Description
31:10	reserved	RO	0	Software should not rely on the value of a reserved bit. To provide compatibility with future products, the value of a reserved bit should be preserved across a read-modify-write operation.
9	RXE	R/W	1	UART Receive Enable If this bit is set to 1, the receive section of the UART is enabled. When the UART is disabled in the middle of a receive, it completes the current character before stopping. Note: To enable reception, the UARTEN bit must also be set.
8	TXE	R/W	1	UART Transmit Enable If this bit is set to 1, the transmit section of the UART is enabled. When the UART is disabled in the middle of a transmission, it completes the current character before stopping. Note: To enable transmission, the UARTEN bit must also be set.

Bit/Field	Name	Type	Reset	Description
7	LBE	R/W	0	UART Loop Back Enable If this bit is set to 1, the U_nTX path is fed through the U_nRX path.
6:1	reserved	RO	0	Software should not rely on the value of a reserved bit. To provide compatibility with future products, the value of a reserved bit should be preserved across a read-modify-write operation.
0	UARTEN	R/W	0	UART Enable If this bit is set to 1, the UART is enabled. When the UART is disabled in the middle of transmission or reception, it completes the current character before stopping.

Register 8: UART Interrupt FIFO Level Select (UARTIFLS), offset 0x034

The **UARTIFLS** register is the interrupt FIFO level select register. You can use this register to define the FIFO level at which the **TXRIS** and **RXRIS** bits in the **UARTRIS** register are triggered.

The interrupts are generated based on a transition through a level rather than being based on the level. That is, the interrupts are generated when the fill level progresses through the trigger level. For example, if the receive trigger level is set to the half-way mark, the interrupt is triggered as the module is receiving the 9th character.

Out of reset, the **TXIFLSEL** and **RXIFLSEL** bits are configured so that the FIFOs trigger an interrupt at the half-way mark.

UART Interrupt FIFO Level Select (UARTIFLS)

UART0 base: 0x4000.C000
 UART1 base: 0x4000.D000
 Offset 0x034
 Type R/W, reset 0x0000.0012

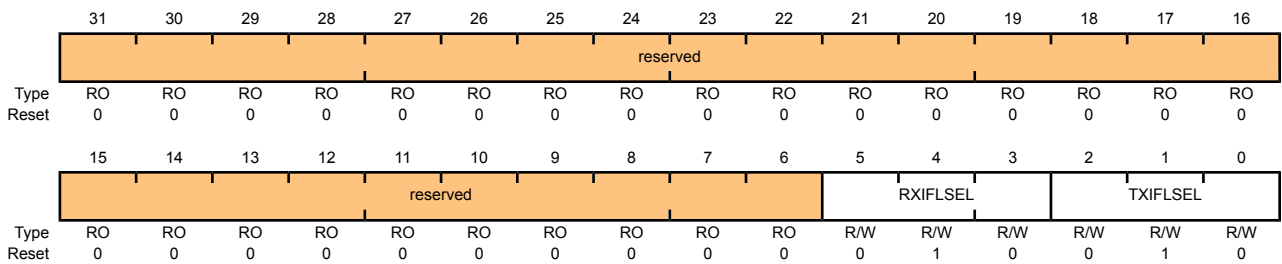

Bit/Field	Name	Type	Reset	Description
31:6	reserved	RO	0x00	Software should not rely on the value of a reserved bit. To provide compatibility with future products, the value of a reserved bit should be preserved across a read-modify-write operation.
5:3	RXIFLSEL	R/W	0x2	UART Receive Interrupt FIFO Level Select

The trigger points for the receive interrupt are as follows:

Value	Description
0x0	RX FIFO \geq 1/8 full
0x1	RX FIFO \geq 1/4 full
0x2	RX FIFO \geq 1/2 full (default)
0x3	RX FIFO \geq 3/4 full
0x4	RX FIFO \geq 7/8 full
0x5-0x7	Reserved

Bit/Field	Name	Type	Reset	Description
2:0	TXIFLSEL	R/W	0x2	UART Transmit Interrupt FIFO Level Select The trigger points for the transmit interrupt are as follows: Value Description 0x0 TX FIFO \leq 1/8 full 0x1 TX FIFO \leq 1/4 full 0x2 TX FIFO \leq 1/2 full (default) 0x3 TX FIFO \leq 3/4 full 0x4 TX FIFO \leq 7/8 full 0x5-0x7 Reserved

Register 9: UART Interrupt Mask (UARTIM), offset 0x038

The **UARTIM** register is the interrupt mask set/clear register.

On a read, this register gives the current value of the mask on the relevant interrupt. Writing a 1 to a bit allows the corresponding raw interrupt signal to be routed to the interrupt controller. Writing a 0 prevents the raw interrupt signal from being sent to the interrupt controller.

UART Interrupt Mask (UARTIM)

UART0 base: 0x4000.C000
 UART1 base: 0x4000.D000
 Offset 0x038
 Type R/W, reset 0x0000.0000

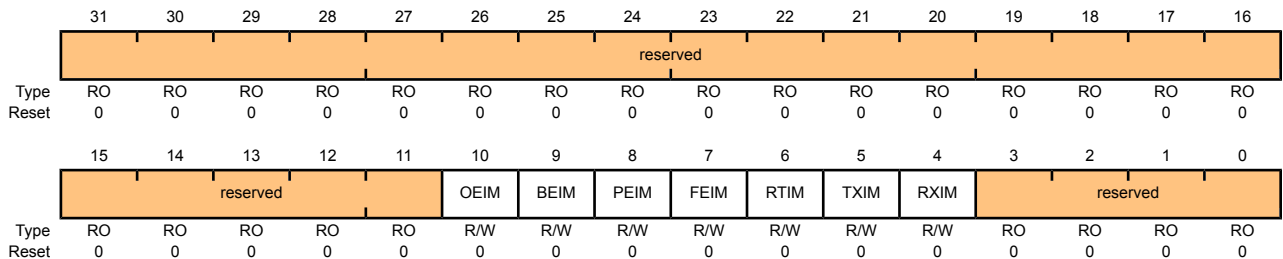

Bit/Field	Name	Type	Reset	Description
31:11	reserved	RO	0x00	Software should not rely on the value of a reserved bit. To provide compatibility with future products, the value of a reserved bit should be preserved across a read-modify-write operation.
10	OEIM	R/W	0	UART Overrun Error Interrupt Mask On a read, the current mask for the OEIM interrupt is returned. Setting this bit to 1 promotes the OEIM interrupt to the interrupt controller.
9	BEIM	R/W	0	UART Break Error Interrupt Mask On a read, the current mask for the BEIM interrupt is returned. Setting this bit to 1 promotes the BEIM interrupt to the interrupt controller.
8	PEIM	R/W	0	UART Parity Error Interrupt Mask On a read, the current mask for the PEIM interrupt is returned. Setting this bit to 1 promotes the PEIM interrupt to the interrupt controller.
7	FEIM	R/W	0	UART Framing Error Interrupt Mask On a read, the current mask for the FEIM interrupt is returned. Setting this bit to 1 promotes the FEIM interrupt to the interrupt controller.
6	RTIM	R/W	0	UART Receive Time-Out Interrupt Mask On a read, the current mask for the RTIM interrupt is returned. Setting this bit to 1 promotes the RTIM interrupt to the interrupt controller.
5	TXIM	R/W	0	UART Transmit Interrupt Mask On a read, the current mask for the TXIM interrupt is returned. Setting this bit to 1 promotes the TXIM interrupt to the interrupt controller.

Bit/Field	Name	Type	Reset	Description
4	RXIM	R/W	0	UART Receive Interrupt Mask On a read, the current mask for the <code>RXIM</code> interrupt is returned. Setting this bit to 1 promotes the <code>RXIM</code> interrupt to the interrupt controller.
3:0	reserved	RO	0x00	Software should not rely on the value of a reserved bit. To provide compatibility with future products, the value of a reserved bit should be preserved across a read-modify-write operation.

Register 10: UART Raw Interrupt Status (UARTRIS), offset 0x03C

The **UARTRIS** register is the raw interrupt status register. On a read, this register gives the current raw status value of the corresponding interrupt. A write has no effect.

UART Raw Interrupt Status (UARTRIS)

UART0 base: 0x4000.C000
 UART1 base: 0x4000.D000
 Offset 0x03C
 Type RO, reset 0x0000.000F

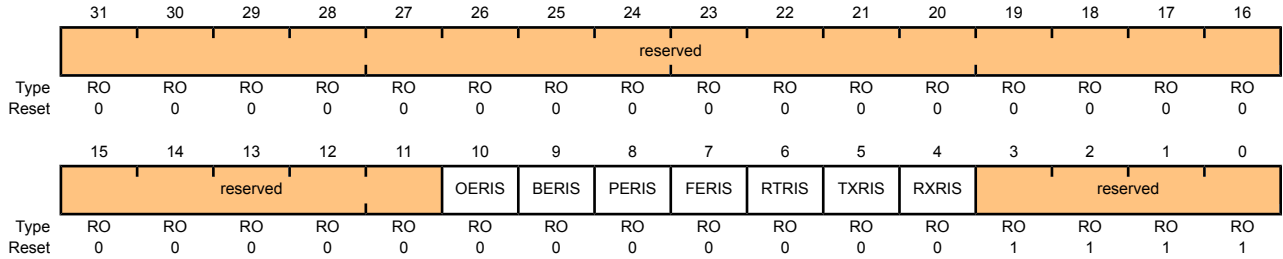

Bit/Field	Name	Type	Reset	Description
31:11	reserved	RO	0x00	Software should not rely on the value of a reserved bit. To provide compatibility with future products, the value of a reserved bit should be preserved across a read-modify-write operation.
10	OERIS	RO	0	UART Overrun Error Raw Interrupt Status Gives the raw interrupt state (prior to masking) of this interrupt.
9	BERIS	RO	0	UART Break Error Raw Interrupt Status Gives the raw interrupt state (prior to masking) of this interrupt.
8	PERIS	RO	0	UART Parity Error Raw Interrupt Status Gives the raw interrupt state (prior to masking) of this interrupt.
7	FERIS	RO	0	UART Framing Error Raw Interrupt Status Gives the raw interrupt state (prior to masking) of this interrupt.
6	RTRIS	RO	0	UART Receive Time-Out Raw Interrupt Status Gives the raw interrupt state (prior to masking) of this interrupt.
5	TXRIS	RO	0	UART Transmit Raw Interrupt Status Gives the raw interrupt state (prior to masking) of this interrupt.
4	RXRIS	RO	0	UART Receive Raw Interrupt Status Gives the raw interrupt state (prior to masking) of this interrupt.
3:0	reserved	RO	0xF	Software should not rely on the value of a reserved bit. To provide compatibility with future products, the value of a reserved bit should be preserved across a read-modify-write operation.

Register 11: UART Masked Interrupt Status (UARTMIS), offset 0x040

The **UARTMIS** register is the masked interrupt status register. On a read, this register gives the current masked status value of the corresponding interrupt. A write has no effect.

UART Masked Interrupt Status (UARTMIS)

UART0 base: 0x4000.C000

UART1 base: 0x4000.D000

Offset 0x040

Type RO, reset 0x0000.0000

	31	30	29	28	27	26	25	24	23	22	21	20	19	18	17	16
	reserved															
Type	RO	RO	RO	RO	RO	RO	RO	RO	RO	RO	RO	RO	RO	RO	RO	RO
Reset	0	0	0	0	0	0	0	0	0	0	0	0	0	0	0	0
	15	14	13	12	11	10	9	8	7	6	5	4	3	2	1	0
	reserved					OEMIS	BEMIS	PEMIS	FEMIS	RTMIS	TXMIS	RXMIS	reserved			
Type	RO	RO	RO	RO	RO	RO	RO	RO	RO	RO	RO	RO	RO	RO	RO	RO
Reset	0	0	0	0	0	0	0	0	0	0	0	0	0	0	0	0

Bit/Field	Name	Type	Reset	Description
31:11	reserved	RO	0x00	Software should not rely on the value of a reserved bit. To provide compatibility with future products, the value of a reserved bit should be preserved across a read-modify-write operation.
10	OEMIS	RO	0	UART Overrun Error Masked Interrupt Status Gives the masked interrupt state of this interrupt.
9	BEMIS	RO	0	UART Break Error Masked Interrupt Status Gives the masked interrupt state of this interrupt.
8	PEMIS	RO	0	UART Parity Error Masked Interrupt Status Gives the masked interrupt state of this interrupt.
7	FEMIS	RO	0	UART Framing Error Masked Interrupt Status Gives the masked interrupt state of this interrupt.
6	RTMIS	RO	0	UART Receive Time-Out Masked Interrupt Status Gives the masked interrupt state of this interrupt.
5	TXMIS	RO	0	UART Transmit Masked Interrupt Status Gives the masked interrupt state of this interrupt.
4	RXMIS	RO	0	UART Receive Masked Interrupt Status Gives the masked interrupt state of this interrupt.
3:0	reserved	RO	0	Software should not rely on the value of a reserved bit. To provide compatibility with future products, the value of a reserved bit should be preserved across a read-modify-write operation.

Register 12: UART Interrupt Clear (UARTICR), offset 0x044

The **UARTICR** register is the interrupt clear register. On a write of 1, the corresponding interrupt (both raw interrupt and masked interrupt, if enabled) is cleared. A write of 0 has no effect.

UART Interrupt Clear (UARTICR)

UART0 base: 0x4000.C000
 UART1 base: 0x4000.D000
 Offset 0x044
 Type W1C, reset 0x0000.0000

	31	30	29	28	27	26	25	24	23	22	21	20	19	18	17	16
	reserved															
Type	RO	RO	RO	RO	RO	RO	RO	RO	RO	RO	RO	RO	RO	RO	RO	RO
Reset	0	0	0	0	0	0	0	0	0	0	0	0	0	0	0	0
	15	14	13	12	11	10	9	8	7	6	5	4	3	2	1	0
	reserved					OEIC	BEIC	PEIC	FEIC	RTIC	TXIC	RXIC	reserved			
Type	RO	RO	RO	RO	RO	W1C	W1C	W1C	W1C	W1C	W1C	W1C	RO	RO	RO	RO
Reset	0	0	0	0	0	0	0	0	0	0	0	0	0	0	0	0

Bit/Field	Name	Type	Reset	Description
31:11	reserved	RO	0x00	Software should not rely on the value of a reserved bit. To provide compatibility with future products, the value of a reserved bit should be preserved across a read-modify-write operation.
10	OEIC	W1C	0	Overrun Error Interrupt Clear The OEIC values are defined as follows: Value Description 0 No effect on the interrupt. 1 Clears interrupt.
9	BEIC	W1C	0	Break Error Interrupt Clear The BEIC values are defined as follows: Value Description 0 No effect on the interrupt. 1 Clears interrupt.
8	PEIC	W1C	0	Parity Error Interrupt Clear The PEIC values are defined as follows: Value Description 0 No effect on the interrupt. 1 Clears interrupt.

Bit/Field	Name	Type	Reset	Description
7	FEIC	W1C	0	Framing Error Interrupt Clear The FEIC values are defined as follows: Value Description 0 No effect on the interrupt. 1 Clears interrupt.
6	RTIC	W1C	0	Receive Time-Out Interrupt Clear The RTIC values are defined as follows: Value Description 0 No effect on the interrupt. 1 Clears interrupt.
5	TXIC	W1C	0	Transmit Interrupt Clear The TXIC values are defined as follows: Value Description 0 No effect on the interrupt. 1 Clears interrupt.
4	RXIC	W1C	0	Receive Interrupt Clear The RXIC values are defined as follows: Value Description 0 No effect on the interrupt. 1 Clears interrupt.
3:0	reserved	RO	0x00	Software should not rely on the value of a reserved bit. To provide compatibility with future products, the value of a reserved bit should be preserved across a read-modify-write operation.

Register 13: UART Peripheral Identification 4 (UARTPeriphID4), offset 0xFD0

The **UARTPeriphIDn** registers are hard-coded and the fields within the registers determine the reset values.

UART Peripheral Identification 4 (UARTPeriphID4)

UART0 base: 0x4000.C000
 UART1 base: 0x4000.D000
 Offset 0xFD0
 Type RO, reset 0x0000.0000

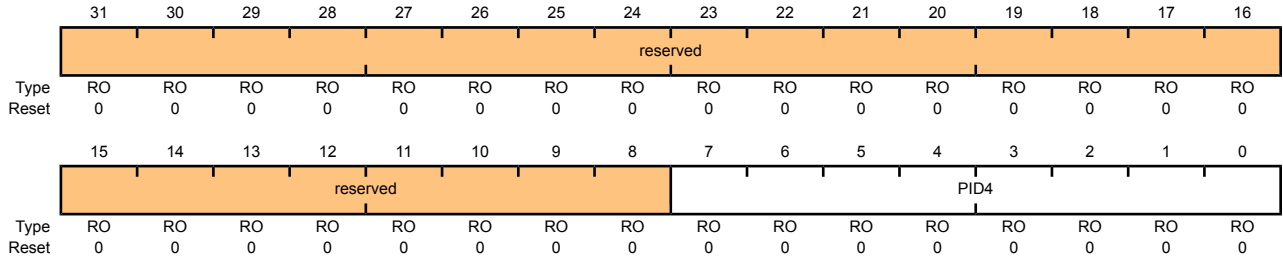

Bit/Field	Name	Type	Reset	Description
31:8	reserved	RO	0x00	Software should not rely on the value of a reserved bit. To provide compatibility with future products, the value of a reserved bit should be preserved across a read-modify-write operation.
7:0	PID4	RO	0x0000	UART Peripheral ID Register[7:0] Can be used by software to identify the presence of this peripheral.

Register 14: UART Peripheral Identification 5 (UARTPeriphID5), offset 0xFD4

The **UARTPeriphIDn** registers are hard-coded and the fields within the registers determine the reset values.

UART Peripheral Identification 5 (UARTPeriphID5)

UART0 base: 0x4000.C000

UART1 base: 0x4000.D000

Offset 0xFD4

Type RO, reset 0x0000.0000

	31	30	29	28	27	26	25	24	23	22	21	20	19	18	17	16
	reserved															
Type	RO	RO	RO	RO	RO	RO	RO	RO	RO	RO	RO	RO	RO	RO	RO	RO
Reset	0	0	0	0	0	0	0	0	0	0	0	0	0	0	0	0
	15	14	13	12	11	10	9	8	7	6	5	4	3	2	1	0
	reserved								PID5							
Type	RO	RO	RO	RO	RO	RO	RO	RO	RO	RO	RO	RO	RO	RO	RO	RO
Reset	0	0	0	0	0	0	0	0	0	0	0	0	0	0	0	0

Bit/Field	Name	Type	Reset	Description
31:8	reserved	RO	0x00	Software should not rely on the value of a reserved bit. To provide compatibility with future products, the value of a reserved bit should be preserved across a read-modify-write operation.
7:0	PID5	RO	0x0000	UART Peripheral ID Register[15:8] Can be used by software to identify the presence of this peripheral.

Register 15: UART Peripheral Identification 6 (UARTPeriphID6), offset 0xFD8

The **UARTPeriphIDn** registers are hard-coded and the fields within the registers determine the reset values.

UART Peripheral Identification 6 (UARTPeriphID6)

UART0 base: 0x4000.C000
 UART1 base: 0x4000.D000
 Offset 0xFD8
 Type RO, reset 0x0000.0000

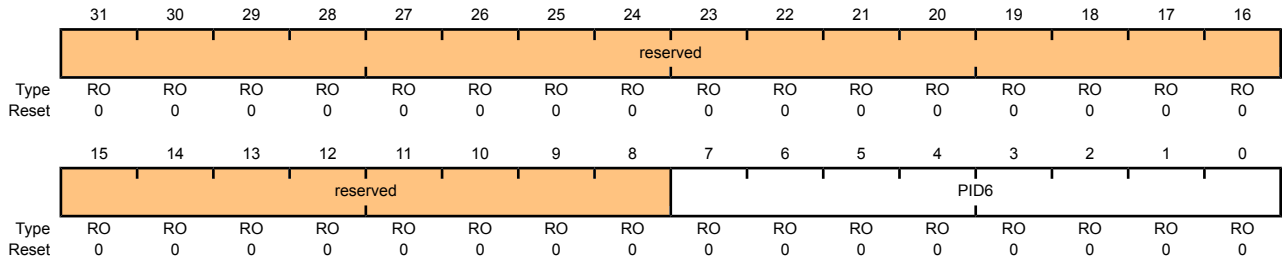

Bit/Field	Name	Type	Reset	Description
31:8	reserved	RO	0x00	Software should not rely on the value of a reserved bit. To provide compatibility with future products, the value of a reserved bit should be preserved across a read-modify-write operation.
7:0	PID6	RO	0x0000	UART Peripheral ID Register[23:16] Can be used by software to identify the presence of this peripheral.

Register 16: UART Peripheral Identification 7 (UARTPeriphID7), offset 0xFDC

The **UARTPeriphIDn** registers are hard-coded and the fields within the registers determine the reset values.

UART Peripheral Identification 7 (UARTPeriphID7)

UART0 base: 0x4000.C000

UART1 base: 0x4000.D000

Offset 0xFDC

Type RO, reset 0x0000.0000

	31	30	29	28	27	26	25	24	23	22	21	20	19	18	17	16
	reserved															
Type	RO	RO	RO	RO	RO	RO	RO	RO	RO	RO	RO	RO	RO	RO	RO	RO
Reset	0	0	0	0	0	0	0	0	0	0	0	0	0	0	0	0
	15	14	13	12	11	10	9	8	7	6	5	4	3	2	1	0
	reserved								PID7							
Type	RO	RO	RO	RO	RO	RO	RO	RO	RO	RO	RO	RO	RO	RO	RO	RO
Reset	0	0	0	0	0	0	0	0	0	0	0	0	0	0	0	0

Bit/Field	Name	Type	Reset	Description
31:8	reserved	RO	0	Software should not rely on the value of a reserved bit. To provide compatibility with future products, the value of a reserved bit should be preserved across a read-modify-write operation.
7:0	PID7	RO	0x0000	UART Peripheral ID Register[31:24] Can be used by software to identify the presence of this peripheral.

Register 17: UART Peripheral Identification 0 (UARTPeriphID0), offset 0xFE0

The **UARTPeriphIDn** registers are hard-coded and the fields within the registers determine the reset values.

UART Peripheral Identification 0 (UARTPeriphID0)

UART0 base: 0x4000.C000
 UART1 base: 0x4000.D000
 Offset 0xFE0
 Type RO, reset 0x0000.0011

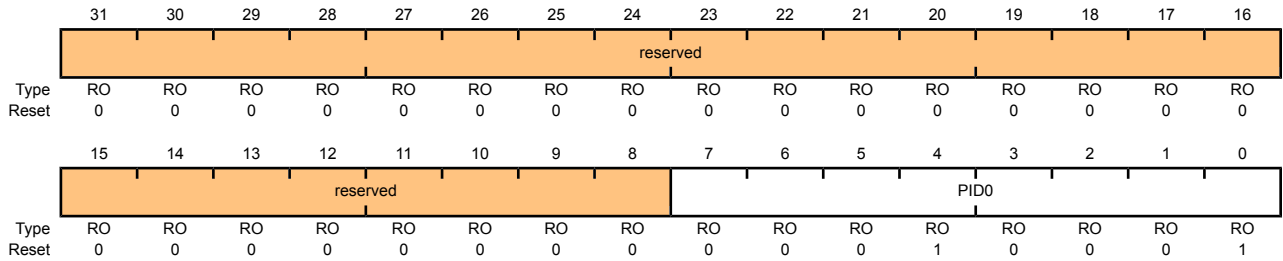

Bit/Field	Name	Type	Reset	Description
31:8	reserved	RO	0x00	Software should not rely on the value of a reserved bit. To provide compatibility with future products, the value of a reserved bit should be preserved across a read-modify-write operation.
7:0	PID0	RO	0x11	UART Peripheral ID Register[7:0] Can be used by software to identify the presence of this peripheral.

Register 18: UART Peripheral Identification 1 (UARTPeriphID1), offset 0xFE4

The **UARTPeriphIDn** registers are hard-coded and the fields within the registers determine the reset values.

UART Peripheral Identification 1 (UARTPeriphID1)

UART0 base: 0x4000.C000

UART1 base: 0x4000.D000

Offset 0xFE4

Type RO, reset 0x0000.0000

	31	30	29	28	27	26	25	24	23	22	21	20	19	18	17	16
	reserved															
Type	RO	RO	RO	RO	RO	RO	RO	RO	RO	RO	RO	RO	RO	RO	RO	RO
Reset	0	0	0	0	0	0	0	0	0	0	0	0	0	0	0	0
	15	14	13	12	11	10	9	8	7	6	5	4	3	2	1	0
	reserved								PID1							
Type	RO	RO	RO	RO	RO	RO	RO	RO	RO	RO	RO	RO	RO	RO	RO	RO
Reset	0	0	0	0	0	0	0	0	0	0	0	0	0	0	0	0

Bit/Field	Name	Type	Reset	Description
31:8	reserved	RO	0x00	Software should not rely on the value of a reserved bit. To provide compatibility with future products, the value of a reserved bit should be preserved across a read-modify-write operation.
7:0	PID1	RO	0x00	UART Peripheral ID Register[15:8] Can be used by software to identify the presence of this peripheral.

Register 19: UART Peripheral Identification 2 (UARTPeriphID2), offset 0xFE8

The **UARTPeriphIDn** registers are hard-coded and the fields within the registers determine the reset values.

UART Peripheral Identification 2 (UARTPeriphID2)

UART0 base: 0x4000.C000
 UART1 base: 0x4000.D000
 Offset 0xFE8
 Type RO, reset 0x0000.0018

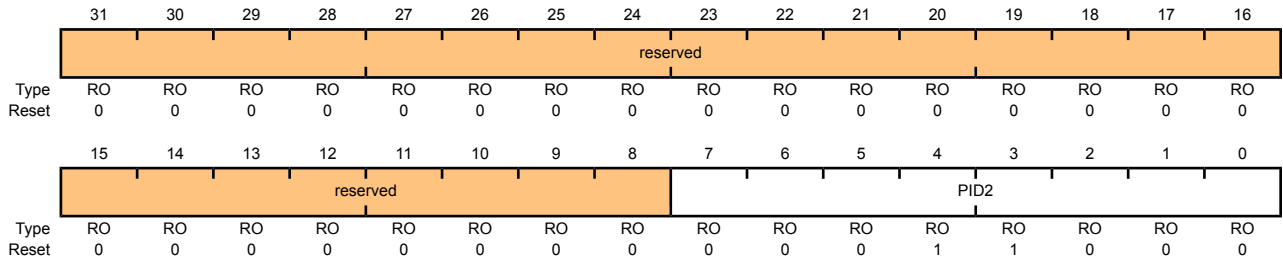

Bit/Field	Name	Type	Reset	Description
31:8	reserved	RO	0x00	Software should not rely on the value of a reserved bit. To provide compatibility with future products, the value of a reserved bit should be preserved across a read-modify-write operation.
7:0	PID2	RO	0x18	UART Peripheral ID Register[23:16] Can be used by software to identify the presence of this peripheral.

Register 20: UART Peripheral Identification 3 (UARTPeriphID3), offset 0xFEC

The **UARTPeriphIDn** registers are hard-coded and the fields within the registers determine the reset values.

UART Peripheral Identification 3 (UARTPeriphID3)

UART0 base: 0x4000.C000

UART1 base: 0x4000.D000

Offset 0xFEC

Type RO, reset 0x0000.0001

	31	30	29	28	27	26	25	24	23	22	21	20	19	18	17	16
	reserved															
Type	RO	RO	RO	RO	RO	RO	RO	RO	RO	RO	RO	RO	RO	RO	RO	RO
Reset	0	0	0	0	0	0	0	0	0	0	0	0	0	0	0	0
	15	14	13	12	11	10	9	8	7	6	5	4	3	2	1	0
	reserved								PID3							
Type	RO	RO	RO	RO	RO	RO	RO	RO	RO	RO	RO	RO	RO	RO	RO	RO
Reset	0	0	0	0	0	0	0	0	0	0	0	0	0	0	0	1

Bit/Field	Name	Type	Reset	Description
31:8	reserved	RO	0x00	Software should not rely on the value of a reserved bit. To provide compatibility with future products, the value of a reserved bit should be preserved across a read-modify-write operation.
7:0	PID3	RO	0x01	UART Peripheral ID Register[31:24] Can be used by software to identify the presence of this peripheral.

Register 21: UART PrimeCell Identification 0 (UARTPCellID0), offset 0xFF0

The **UARTPCellIDn** registers are hard-coded and the fields within the registers determine the reset values.

UART PrimeCell Identification 0 (UARTPCellID0)

UART0 base: 0x4000.C000
 UART1 base: 0x4000.D000
 Offset 0xFF0
 Type RO, reset 0x0000.000D

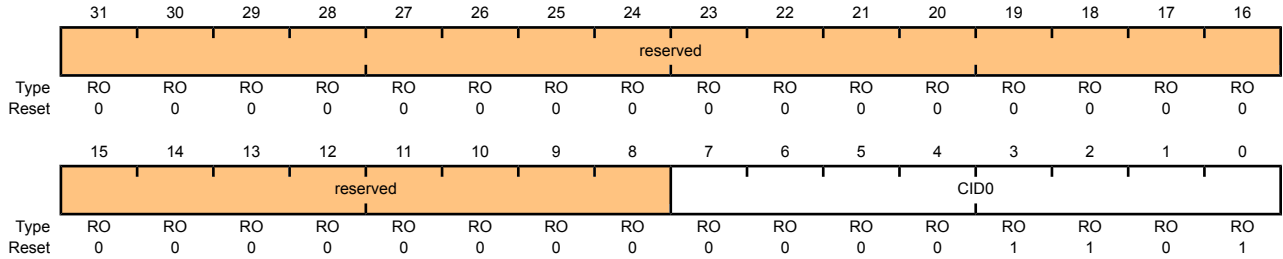

Bit/Field	Name	Type	Reset	Description
31:8	reserved	RO	0x00	Software should not rely on the value of a reserved bit. To provide compatibility with future products, the value of a reserved bit should be preserved across a read-modify-write operation.
7:0	CID0	RO	0x0D	UART PrimeCell ID Register[7:0] Provides software a standard cross-peripheral identification system.

Register 22: UART PrimeCell Identification 1 (UARTPCelIID1), offset 0xFF4

The **UARTPCelIIDn** registers are hard-coded and the fields within the registers determine the reset values.

UART PrimeCell Identification 1 (UARTPCelIID1)

UART0 base: 0x4000.C000
 UART1 base: 0x4000.D000
 Offset 0xFF4
 Type RO, reset 0x0000.00F0

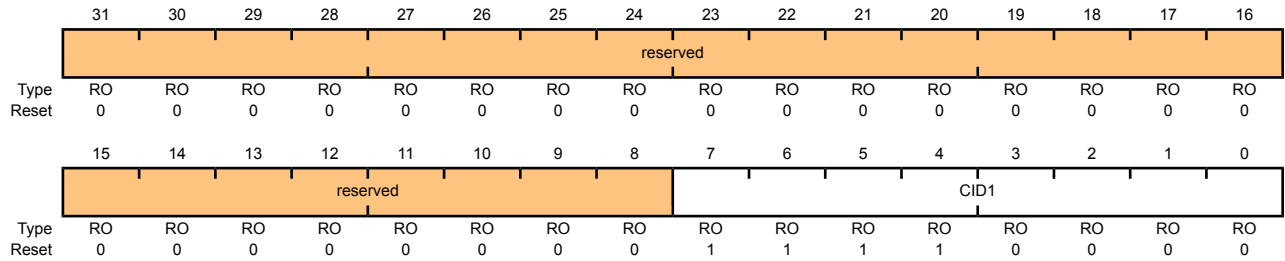

Bit/Field	Name	Type	Reset	Description
31:8	reserved	RO	0x00	Software should not rely on the value of a reserved bit. To provide compatibility with future products, the value of a reserved bit should be preserved across a read-modify-write operation.
7:0	CID1	RO	0xF0	UART PrimeCell ID Register[15:8] Provides software a standard cross-peripheral identification system.

Register 23: UART PrimeCell Identification 2 (UARTPCellID2), offset 0xFF8

The **UARTPCellIDn** registers are hard-coded and the fields within the registers determine the reset values.

UART PrimeCell Identification 2 (UARTPCellID2)

UART0 base: 0x4000.C000
 UART1 base: 0x4000.D000
 Offset 0xFF8
 Type RO, reset 0x0000.0005

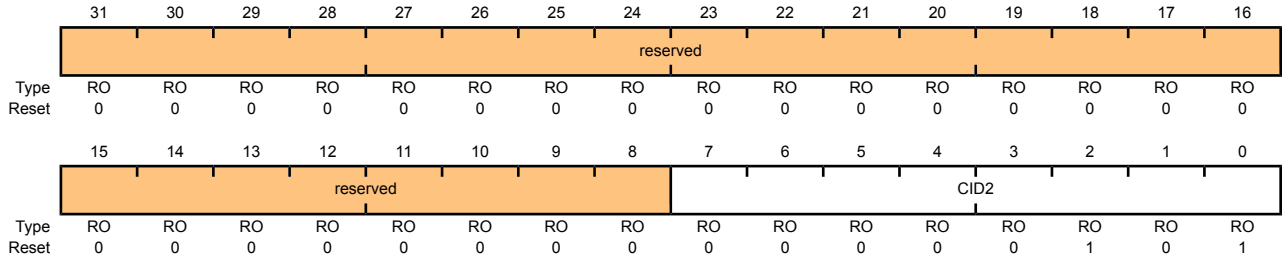

Bit/Field	Name	Type	Reset	Description
31:8	reserved	RO	0x00	Software should not rely on the value of a reserved bit. To provide compatibility with future products, the value of a reserved bit should be preserved across a read-modify-write operation.
7:0	CID2	RO	0x05	UART PrimeCell ID Register[23:16] Provides software a standard cross-peripheral identification system.

Register 24: UART PrimeCell Identification 3 (UARTPCellID3), offset 0xFFC

The **UARTPCellIDn** registers are hard-coded and the fields within the registers determine the reset values.

UART PrimeCell Identification 3 (UARTPCellID3)

UART0 base: 0x4000.C000

UART1 base: 0x4000.D000

Offset 0xFFC

Type RO, reset 0x0000.00B1

	31	30	29	28	27	26	25	24	23	22	21	20	19	18	17	16
	reserved															
Type	RO	RO	RO	RO	RO	RO	RO	RO	RO	RO	RO	RO	RO	RO	RO	RO
Reset	0	0	0	0	0	0	0	0	0	0	0	0	0	0	0	0
	15	14	13	12	11	10	9	8	7	6	5	4	3	2	1	0
	reserved								CID3							
Type	RO	RO	RO	RO	RO	RO	RO	RO	RO	RO	RO	RO	RO	RO	RO	RO
Reset	0	0	0	0	0	0	0	0	1	0	1	1	0	0	0	1

Bit/Field	Name	Type	Reset	Description
31:8	reserved	RO	0x00	Software should not rely on the value of a reserved bit. To provide compatibility with future products, the value of a reserved bit should be preserved across a read-modify-write operation.
7:0	CID3	RO	0xB1	UART PrimeCell ID Register[31:24] Provides software a standard cross-peripheral identification system.

13 Synchronous Serial Interface (SSI)

The Stellaris[®] Synchronous Serial Interface (SSI) is a master or slave interface for synchronous serial communication with peripheral devices that have either Freescale SPI, MICROWIRE, or Texas Instruments synchronous serial interfaces.

The Stellaris[®] SSI module has the following features:

- Master or slave operation
- Programmable clock bit rate and prescale
- Separate transmit and receive FIFOs, 16 bits wide, 8 locations deep
- Programmable interface operation for Freescale SPI, MICROWIRE, or Texas Instruments synchronous serial interfaces
- Programmable data frame size from 4 to 16 bits
- Internal loopback test mode for diagnostic/debug testing

13.1 Block Diagram

Figure 13-1. SSI Module Block Diagram

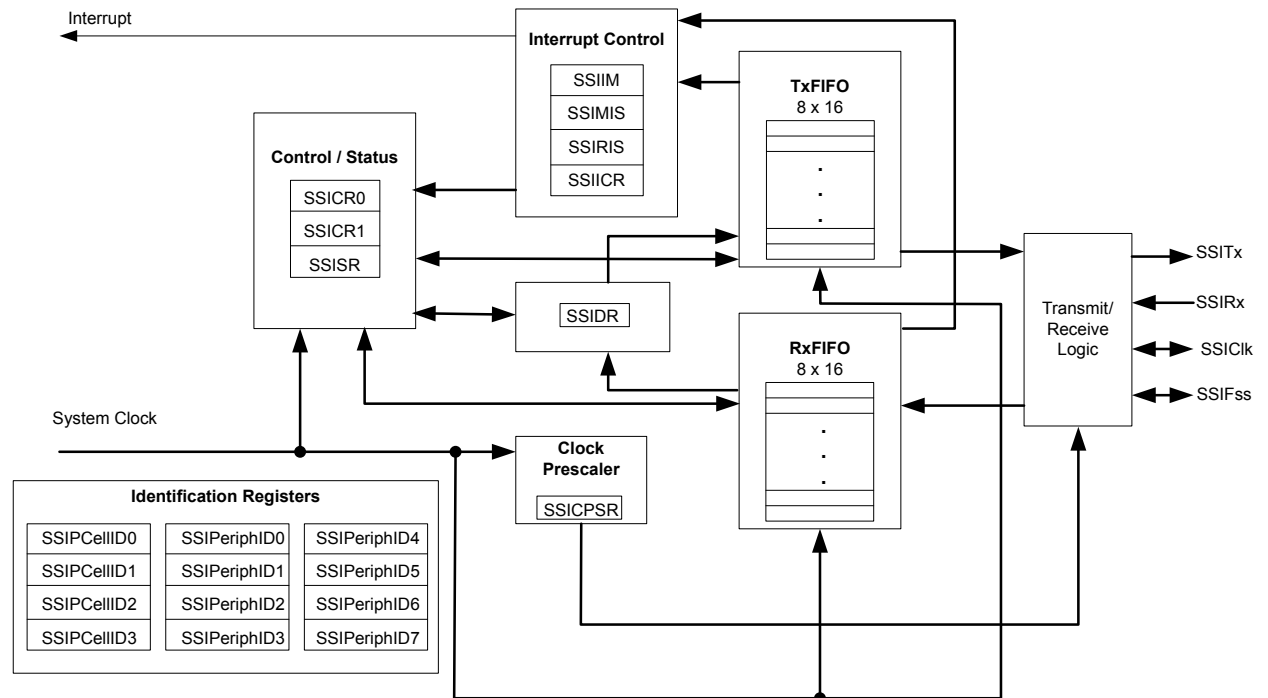

13.2 Functional Description

The SSI performs serial-to-parallel conversion on data received from a peripheral device. The CPU accesses data, control, and status information. The transmit and receive paths are buffered with

internal FIFO memories allowing up to eight 16-bit values to be stored independently in both transmit and receive modes.

13.2.1 Bit Rate Generation

The SSI includes a programmable bit rate clock divider and prescaler to generate the serial output clock. Bit rates are supported to 2 MHz and higher, although maximum bit rate is determined by peripheral devices.

The serial bit rate is derived by dividing down the input clock (FSysClk). The clock is first divided by an even prescale value CPSDVSR from 2 to 254, which is programmed in the **SSI Clock Prescale (SSICPSR)** register (see page 313). The clock is further divided by a value from 1 to 256, which is $1 + SCR$, where SCR is the value programmed in the **SSI Control0 (SSICR0)** register (see page 306).

The frequency of the output clock SSIClk is defined by:

$$SSIClk = F_{SysClk} / (CPSDVSR * (1 + SCR))$$

Note: Although the SSIClk transmit clock can theoretically be 25 MHz, the module may not be able to operate at that speed. For master mode, the system clock must be at least two times faster than the SSIClk. For slave mode, the system clock must be at least 12 times faster than the SSIClk.

See “Synchronous Serial Interface (SSI)” on page 378 to view SSI timing parameters.

13.2.2 FIFO Operation

13.2.2.1 Transmit FIFO

The common transmit FIFO is a 16-bit wide, 8-locations deep, first-in, first-out memory buffer. The CPU writes data to the FIFO by writing the **SSI Data (SSIDR)** register (see page 310), and data is stored in the FIFO until it is read out by the transmission logic.

When configured as a master or a slave, parallel data is written into the transmit FIFO prior to serial conversion and transmission to the attached slave or master, respectively, through the SSITx pin.

13.2.2.2 Receive FIFO

The common receive FIFO is a 16-bit wide, 8-locations deep, first-in, first-out memory buffer. Received data from the serial interface is stored in the buffer until read out by the CPU, which accesses the read FIFO by reading the **SSIDR** register.

When configured as a master or slave, serial data received through the SSIRx pin is registered prior to parallel loading into the attached slave or master receive FIFO, respectively.

13.2.3 Interrupts

The SSI can generate interrupts when the following conditions are observed:

- Transmit FIFO service
- Receive FIFO service
- Receive FIFO time-out
- Receive FIFO overrun

All of the interrupt events are ORed together before being sent to the interrupt controller, so the SSI can only generate a single interrupt request to the controller at any given time. You can mask each of the four individual maskable interrupts by setting the appropriate bits in the **SSI Interrupt Mask (SSIM)** register (see page 314). Setting the appropriate mask bit to 1 enables the interrupt.

Provision of the individual outputs, as well as a combined interrupt output, allows use of either a global interrupt service routine, or modular device drivers to handle interrupts. The transmit and receive dynamic dataflow interrupts have been separated from the status interrupts so that data can be read or written in response to the FIFO trigger levels. The status of the individual interrupt sources can be read from the **SSI Raw Interrupt Status (SSIRIS)** and **SSI Masked Interrupt Status (SSIMIS)** registers (see page 316 and page 317, respectively).

13.2.4 Frame Formats

Each data frame is between 4 and 16 bits long, depending on the size of data programmed, and is transmitted starting with the MSB. There are three basic frame types that can be selected:

- Texas Instruments synchronous serial
- Freescale SPI
- MICROWIRE

For all three formats, the serial clock (*SSIClk*) is held inactive while the SSI is idle, and *SSIClk* transitions at the programmed frequency only during active transmission or reception of data. The idle state of *SSIClk* is utilized to provide a receive timeout indication that occurs when the receive FIFO still contains data after a timeout period.

For Freescale SPI and MICROWIRE frame formats, the serial frame (*SSIFSS*) pin is active Low, and is asserted (pulled down) during the entire transmission of the frame.

For Texas Instruments synchronous serial frame format, the *SSIFSS* pin is pulsed for one serial clock period starting at its rising edge, prior to the transmission of each frame. For this frame format, both the SSI and the off-chip slave device drive their output data on the rising edge of *SSIClk*, and latch data from the other device on the falling edge.

Unlike the full-duplex transmission of the other two frame formats, the MICROWIRE format uses a special master-slave messaging technique, which operates at half-duplex. In this mode, when a frame begins, an 8-bit control message is transmitted to the off-chip slave. During this transmit, no incoming data is received by the SSI. After the message has been sent, the off-chip slave decodes it and, after waiting one serial clock after the last bit of the 8-bit control message has been sent, responds with the requested data. The returned data can be 4 to 16 bits in length, making the total frame length anywhere from 13 to 25 bits.

13.2.4.1 Texas Instruments Synchronous Serial Frame Format

Figure 13-2 on page 297 shows the Texas Instruments synchronous serial frame format for a single transmitted frame.

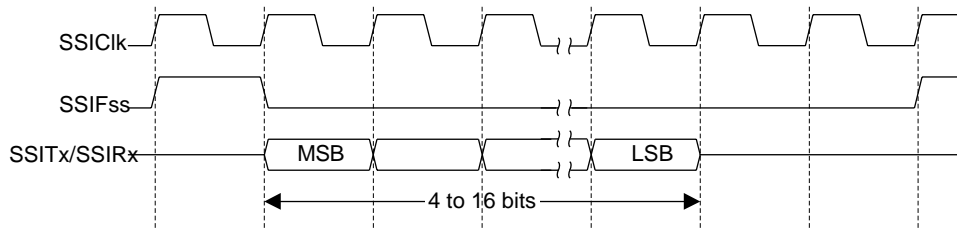
Figure 13-2. TI Synchronous Serial Frame Format (Single Transfer)

In this mode, `SSIClk` and `SSIFss` are forced Low, and the transmit data line `SSITx` is tristated whenever the SSI is idle. Once the bottom entry of the transmit FIFO contains data, `SSIFss` is pulsed High for one `SSIClk` period. The value to be transmitted is also transferred from the transmit FIFO to the serial shift register of the transmit logic. On the next rising edge of `SSIClk`, the MSB of the 4 to 16-bit data frame is shifted out on the `SSITx` pin. Likewise, the MSB of the received data is shifted onto the `SSIRx` pin by the off-chip serial slave device.

Both the SSI and the off-chip serial slave device then clock each data bit into their serial shifter on the falling edge of each `SSIClk`. The received data is transferred from the serial shifter to the receive FIFO on the first rising edge of `SSIClk` after the LSB has been latched.

Figure 13-3 on page 297 shows the Texas Instruments synchronous serial frame format when back-to-back frames are transmitted.

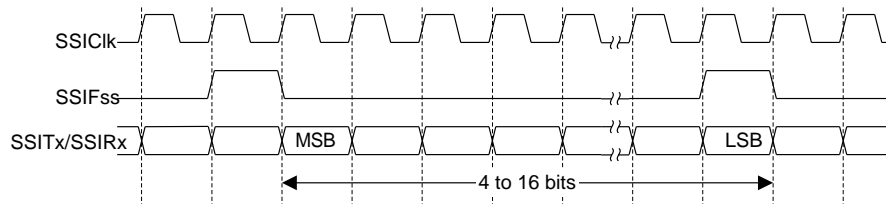
Figure 13-3. TI Synchronous Serial Frame Format (Continuous Transfer)

13.2.4.2 Freescale SPI Frame Format

The Freescale SPI interface is a four-wire interface where the `SSIFss` signal behaves as a slave select. The main feature of the Freescale SPI format is that the inactive state and phase of the `SSIClk` signal are programmable through the `SPO` and `SPH` bits within the `SSISCR0` control register.

SPO Clock Polarity Bit

When the `SPO` clock polarity control bit is Low, it produces a steady state Low value on the `SSIClk` pin. If the `SPO` bit is High, a steady state High value is placed on the `SSIClk` pin when data is not being transferred.

SPH Phase Control Bit

The `SPH` phase control bit selects the clock edge that captures data and allows it to change state. It has the most impact on the first bit transmitted by either allowing or not allowing a clock transition before the first data capture edge. When the `SPH` phase control bit is Low, data is captured on the first clock edge transition. If the `SPH` bit is High, data is captured on the second clock edge transition.

13.2.4.3 Freescale SPI Frame Format with SPO=0 and SPH=0

Single and continuous transmission signal sequences for Freescale SPI format with SPO=0 and SPH=0 are shown in Figure 13-4 on page 298 and Figure 13-5 on page 298.

Figure 13-4. Freescale SPI Format (Single Transfer) with SPO=0 and SPH=0

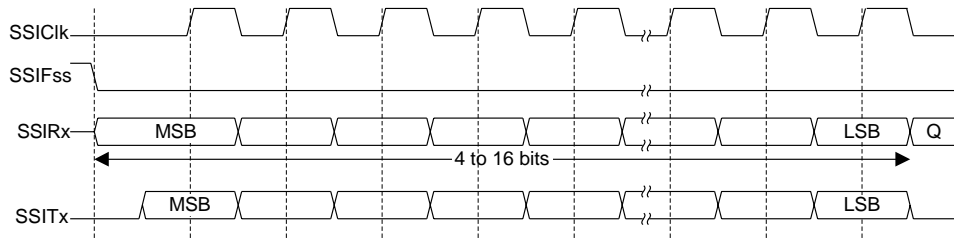

Note: Q is undefined.

Figure 13-5. Freescale SPI Format (Continuous Transfer) with SPO=0 and SPH=0

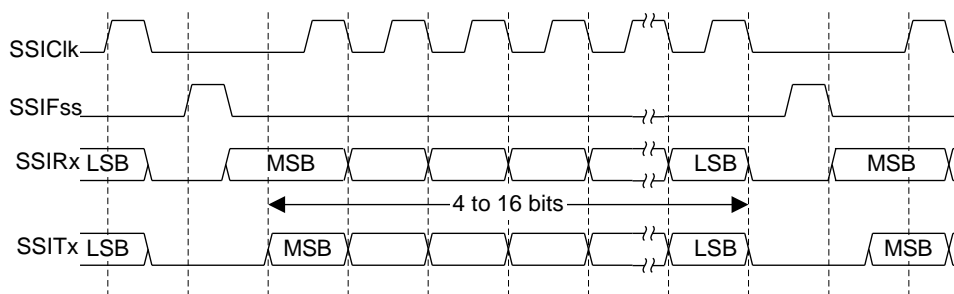

In this configuration, during idle periods:

- SSIClk is forced Low
- SSIFss is forced High
- The transmit data line SSITx is arbitrarily forced Low
- When the SSI is configured as a master, it enables the SSIClk pad
- When the SSI is configured as a slave, it disables the SSIClk pad

If the SSI is enabled and there is valid data within the transmit FIFO, the start of transmission is signified by the SSIFss master signal being driven Low. This causes slave data to be enabled onto the SSIRx input line of the master. The master SSITx output pad is enabled.

One half SSIClk period later, valid master data is transferred to the SSITx pin. Now that both the master and slave data have been set, the SSIClk master clock pin goes High after one further half SSIClk period.

The data is now captured on the rising and propagated on the falling edges of the SSIClk signal.

In the case of a single word transmission, after all bits of the data word have been transferred, the SSIFss line is returned to its idle High state one SSIClk period after the last bit has been captured.

However, in the case of continuous back-to-back transmissions, the SSIFss signal must be pulsed High between each data word transfer. This is because the slave select pin freezes the data in its

serial peripheral register and does not allow it to be altered if the `SPH` bit is logic zero. Therefore, the master device must raise the `SSIFSS` pin of the slave device between each data transfer to enable the serial peripheral data write. On completion of the continuous transfer, the `SSIFSS` pin is returned to its idle state one `SSIClk` period after the last bit has been captured.

13.2.4.4 Freescale SPI Frame Format with `SPO=0` and `SPH=1`

The transfer signal sequence for Freescale SPI format with `SPO=0` and `SPH=1` is shown in Figure 13-6 on page 299, which covers both single and continuous transfers.

Figure 13-6. Freescale SPI Frame Format with `SPO=0` and `SPH=1`

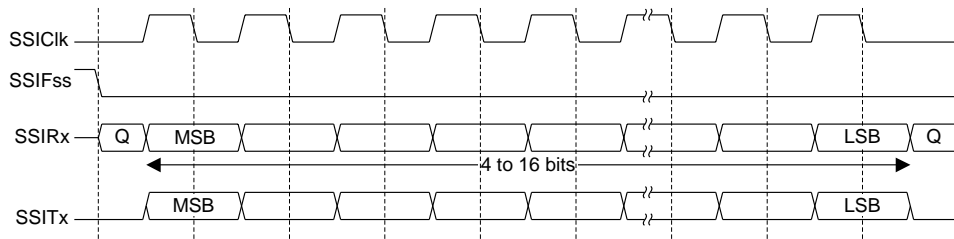

Note: Q is undefined.

In this configuration, during idle periods:

- `SSIClk` is forced Low
- `SSIFss` is forced High
- The transmit data line `SSITx` is arbitrarily forced Low
- When the SSI is configured as a master, it enables the `SSIClk` pad
- When the SSI is configured as a slave, it disables the `SSIClk` pad

If the SSI is enabled and there is valid data within the transmit FIFO, the start of transmission is signified by the `SSIFss` master signal being driven Low. The master `SSITx` output is enabled. After a further one half `SSIClk` period, both master and slave valid data is enabled onto their respective transmission lines. At the same time, the `SSIClk` is enabled with a rising edge transition.

Data is then captured on the falling edges and propagated on the rising edges of the `SSIClk` signal.

In the case of a single word transfer, after all bits have been transferred, the `SSIFss` line is returned to its idle High state one `SSIClk` period after the last bit has been captured.

For continuous back-to-back transfers, the `SSIFss` pin is held Low between successive data words and termination is the same as that of the single word transfer.

13.2.4.5 Freescale SPI Frame Format with `SPO=1` and `SPH=0`

Single and continuous transmission signal sequences for Freescale SPI format with `SPO=1` and `SPH=0` are shown in Figure 13-7 on page 300 and Figure 13-8 on page 300.

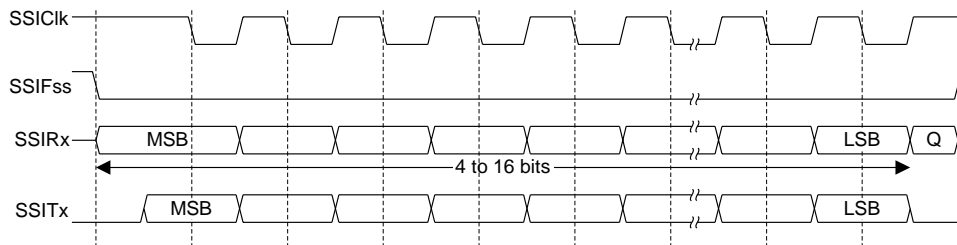
Figure 13-7. Freescale SPI Frame Format (Single Transfer) with SPO=1 and SPH=0

Note: Q is undefined.

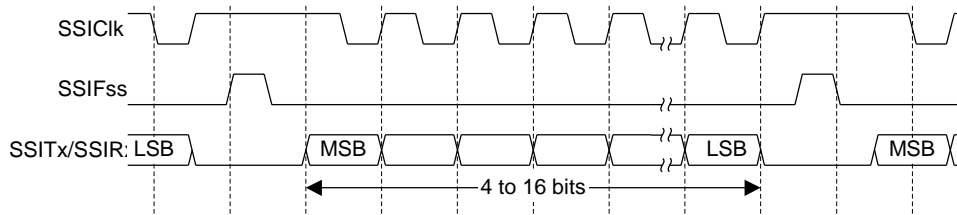
Figure 13-8. Freescale SPI Frame Format (Continuous Transfer) with SPO=1 and SPH=0

In this configuration, during idle periods:

- SSIClk is forced High
- SSIFss is forced High
- The transmit data line SSITx is arbitrarily forced Low
- When the SSI is configured as a master, it enables the SSIClk pad
- When the SSI is configured as a slave, it disables the SSIClk pad

If the SSI is enabled and there is valid data within the transmit FIFO, the start of transmission is signified by the SSIFss master signal being driven Low, which causes slave data to be immediately transferred onto the SSIRx line of the master. The master SSITx output pad is enabled.

One half period later, valid master data is transferred to the SSITx line. Now that both the master and slave data have been set, the SSIClk master clock pin becomes Low after one further half SSIClk period. This means that data is captured on the falling edges and propagated on the rising edges of the SSIClk signal.

In the case of a single word transmission, after all bits of the data word are transferred, the SSIFss line is returned to its idle High state one SSIClk period after the last bit has been captured.

However, in the case of continuous back-to-back transmissions, the SSIFss signal must be pulsed High between each data word transfer. This is because the slave select pin freezes the data in its serial peripheral register and does not allow it to be altered if the SPH bit is logic zero. Therefore, the master device must raise the SSIFss pin of the slave device between each data transfer to enable the serial peripheral data write. On completion of the continuous transfer, the SSIFss pin is returned to its idle state one SSIClk period after the last bit has been captured.

13.2.4.6 Freescale SPI Frame Format with SPO=1 and SPH=1

The transfer signal sequence for Freescale SPI format with SPO=1 and SPH=1 is shown in Figure 13-9 on page 301, which covers both single and continuous transfers.

Figure 13-9. Freescale SPI Frame Format with SPO=1 and SPH=1

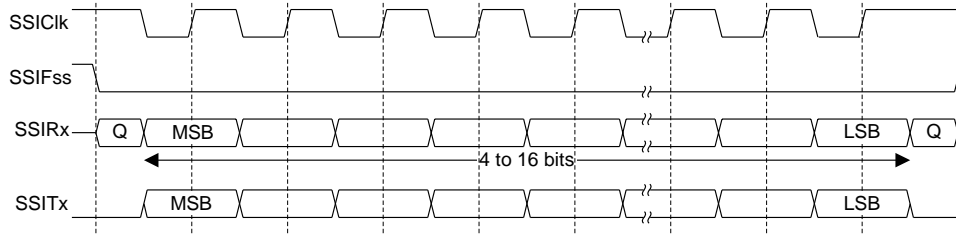

Note: Q is undefined.

In this configuration, during idle periods:

- SSIClk is forced High
- SSIFss is forced High
- The transmit data line SSITx is arbitrarily forced Low
- When the SSI is configured as a master, it enables the SSIClk pad
- When the SSI is configured as a slave, it disables the SSIClk pad

If the SSI is enabled and there is valid data within the transmit FIFO, the start of transmission is signified by the SSIFss master signal being driven Low. The master SSITx output pad is enabled. After a further one-half SSIClk period, both master and slave data are enabled onto their respective transmission lines. At the same time, SSIClk is enabled with a falling edge transition. Data is then captured on the rising edges and propagated on the falling edges of the SSIClk signal.

After all bits have been transferred, in the case of a single word transmission, the SSIFss line is returned to its idle high state one SSIClk period after the last bit has been captured.

For continuous back-to-back transmissions, the SSIFss pin remains in its active Low state, until the final bit of the last word has been captured, and then returns to its idle state as described above.

For continuous back-to-back transfers, the SSIFss pin is held Low between successive data words and termination is the same as that of the single word transfer.

13.2.4.7 MICROWIRE Frame Format

Figure 13-10 on page 302 shows the MICROWIRE frame format, again for a single frame. Figure 13-11 on page 303 shows the same format when back-to-back frames are transmitted.

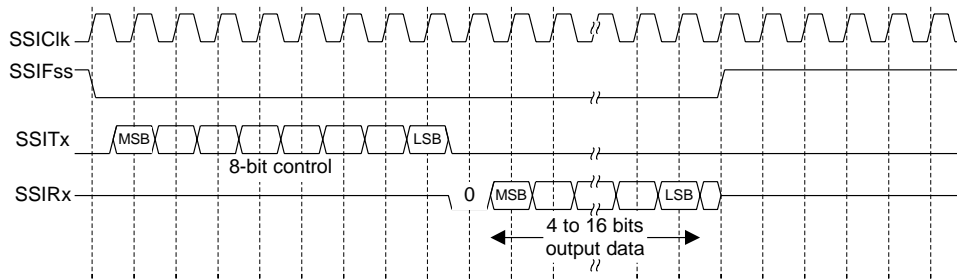
Figure 13-10. MICROWIRE Frame Format (Single Frame)

MICROWIRE format is very similar to SPI format, except that transmission is half-duplex instead of full-duplex, using a master-slave message passing technique. Each serial transmission begins with an 8-bit control word that is transmitted from the SSI to the off-chip slave device. During this transmission, no incoming data is received by the SSI. After the message has been sent, the off-chip slave decodes it and, after waiting one serial clock after the last bit of the 8-bit control message has been sent, responds with the required data. The returned data is 4 to 16 bits in length, making the total frame length anywhere from 13 to 25 bits.

In this configuration, during idle periods:

- SSIClk is forced Low
- SSIFss is forced High
- The transmit data line SSITx is arbitrarily forced Low

A transmission is triggered by writing a control byte to the transmit FIFO. The falling edge of SSIFss causes the value contained in the bottom entry of the transmit FIFO to be transferred to the serial shift register of the transmit logic, and the MSB of the 8-bit control frame to be shifted out onto the SSITx pin. SSIFss remains Low for the duration of the frame transmission. The SSIRx pin remains tristated during this transmission.

The off-chip serial slave device latches each control bit into its serial shifter on the rising edge of each SSIClk. After the last bit is latched by the slave device, the control byte is decoded during a one clock wait-state, and the slave responds by transmitting data back to the SSI. Each bit is driven onto the SSIRx line on the falling edge of SSIClk. The SSI in turn latches each bit on the rising edge of SSIClk. At the end of the frame, for single transfers, the SSIFss signal is pulled High one clock period after the last bit has been latched in the receive serial shifter, which causes the data to be transferred to the receive FIFO.

Note: The off-chip slave device can tristate the receive line either on the falling edge of SSIClk after the LSB has been latched by the receive shifter, or when the SSIFss pin goes High.

For continuous transfers, data transmission begins and ends in the same manner as a single transfer. However, the SSIFss line is continuously asserted (held Low) and transmission of data occurs back-to-back. The control byte of the next frame follows directly after the LSB of the received data from the current frame. Each of the received values is transferred from the receive shifter on the falling edge of SSIClk, after the LSB of the frame has been latched into the SSI.

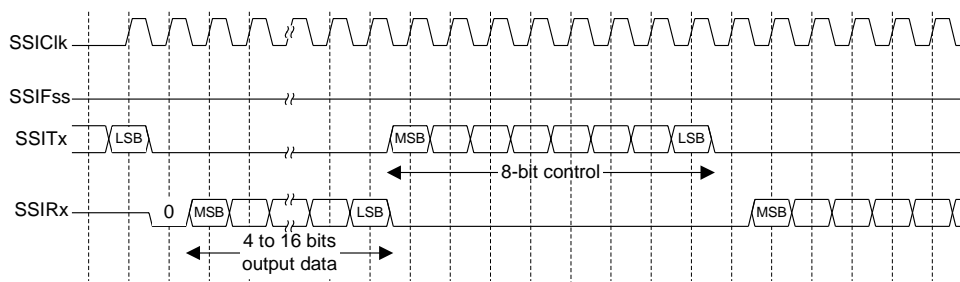
Figure 13-11. MICROWIRE Frame Format (Continuous Transfer)

In the MICROWIRE mode, the SSI slave samples the first bit of receive data on the rising edge of SSIClk after SSIFss has gone Low. Masters that drive a free-running SSIClk must ensure that the SSIFss signal has sufficient setup and hold margins with respect to the rising edge of SSIClk.

Figure 13-12 on page 303 illustrates these setup and hold time requirements. With respect to the SSIClk rising edge on which the first bit of receive data is to be sampled by the SSI slave, SSIFss must have a setup of at least two times the period of SSIClk on which the SSI operates. With respect to the SSIClk rising edge previous to this edge, SSIFss must have a hold of at least one SSIClk period.

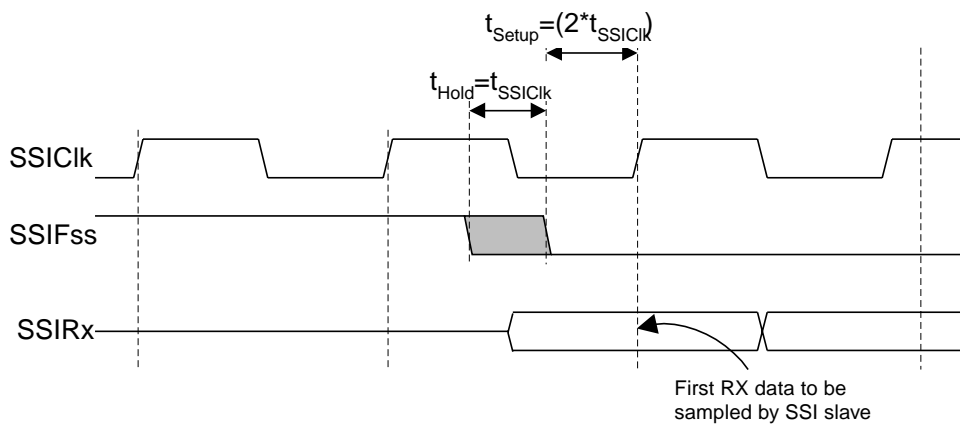
Figure 13-12. MICROWIRE Frame Format, SSIFss Input Setup and Hold Requirements

13.3 Initialization and Configuration

To use the SSI, its peripheral clock must be enabled by setting the SSI bit in the RCGC1 register.

For each of the frame formats, the SSI is configured using the following steps:

1. Ensure that the SSE bit in the SSICR1 register is disabled before making any configuration changes.
2. Select whether the SSI is a master or slave:
 - a. For master operations, set the SSICR1 register to 0x0000.0000.
 - b. For slave mode (output enabled), set the SSICR1 register to 0x0000.0004.
 - c. For slave mode (output disabled), set the SSICR1 register to 0x0000.000C.
3. Configure the clock prescale divisor by writing the SSICPSR register.

4. Write the **SSICR0** register with the following configuration:
 - Serial clock rate (*SCR*)
 - Desired clock phase/polarity, if using Freescale SPI mode (*SPH* and *SPO*)
 - The protocol mode: Freescale SPI, TI SSF, MICROWIRE (*FRF*)
 - The data size (*DSS*)
5. Enable the SSI by setting the *SSE* bit in the **SSICR1** register.

As an example, assume the SSI must be configured to operate with the following parameters:

- Master operation
- Freescale SPI mode (*SPO*=1, *SPH*=1)
- 1 Mbps bit rate
- 8 data bits

Assuming the system clock is 20 MHz, the bit rate calculation would be:

$$F_{SSIClk} = F_{SysClk} / (CPSDVSR * (1 + SCR))$$

$$1 \times 10^6 = 20 \times 10^6 / (CPSDVSR * (1 + SCR))$$

In this case, if *CPSDVSR*=2, *SCR* must be 9.

The configuration sequence would be as follows:

1. Ensure that the *SSE* bit in the **SSICR1** register is disabled.
2. Write the **SSICR1** register with a value of 0x0000.0000.
3. Write the **SSICPSR** register with a value of 0x0000.0002.
4. Write the **SSICR0** register with a value of 0x0000.09C7.
5. The SSI is then enabled by setting the *SSE* bit in the **SSICR1** register to 1.

13.4 Register Map

Table 13-1 on page 304 lists the SSI registers. The offset listed is a hexadecimal increment to the register's address, relative to that SSI module's base address:

- SSI0: 0x4000.8000

Note: The SSI must be disabled (see the *SSE* bit in the **SSICR1** register) before any of the control registers are reprogrammed.

Table 13-1. SSI Register Map

Offset	Name	Type	Reset	Description	See page
0x000	SSICR0	R/W	0x0000.0000	SSI Control 0	306

Offset	Name	Type	Reset	Description	See page
0x004	SSICR1	R/W	0x0000.0000	SSI Control 1	308
0x008	SSIDR	R/W	0x0000.0000	SSI Data	310
0x00C	SSISR	RO	0x0000.0003	SSI Status	311
0x010	SSICPSR	R/W	0x0000.0000	SSI Clock Prescale	313
0x014	SSIIM	R/W	0x0000.0000	SSI Interrupt Mask	314
0x018	SSIRIS	RO	0x0000.0008	SSI Raw Interrupt Status	316
0x01C	SSIMIS	RO	0x0000.0000	SSI Masked Interrupt Status	317
0x020	SSIICR	W1C	0x0000.0000	SSI Interrupt Clear	318
0xFD0	SSIPeriphID4	RO	0x0000.0000	SSI Peripheral Identification 4	319
0xFD4	SSIPeriphID5	RO	0x0000.0000	SSI Peripheral Identification 5	320
0xFD8	SSIPeriphID6	RO	0x0000.0000	SSI Peripheral Identification 6	321
0xFDC	SSIPeriphID7	RO	0x0000.0000	SSI Peripheral Identification 7	322
0xFE0	SSIPeriphID0	RO	0x0000.0022	SSI Peripheral Identification 0	323
0xFE4	SSIPeriphID1	RO	0x0000.0000	SSI Peripheral Identification 1	324
0xFE8	SSIPeriphID2	RO	0x0000.0018	SSI Peripheral Identification 2	325
0xFEC	SSIPeriphID3	RO	0x0000.0001	SSI Peripheral Identification 3	326
0xFF0	SSIPCellID0	RO	0x0000.000D	SSI PrimeCell Identification 0	327
0xFF4	SSIPCellID1	RO	0x0000.00F0	SSI PrimeCell Identification 1	328
0xFF8	SSIPCellID2	RO	0x0000.0005	SSI PrimeCell Identification 2	329
0xFFC	SSIPCellID3	RO	0x0000.00B1	SSI PrimeCell Identification 3	330

13.5 Register Descriptions

The remainder of this section lists and describes the SSI registers, in numerical order by address offset.

Register 1: SSI Control 0 (SSICR0), offset 0x000

SSICR0 is control register 0 and contains bit fields that control various functions within the SSI module. Functionality such as protocol mode, clock rate, and data size are configured in this register.

SSI Control 0 (SSICR0)

SSI0 base: 0x4000.8000
 Offset 0x000
 Type R/W, reset 0x0000.0000

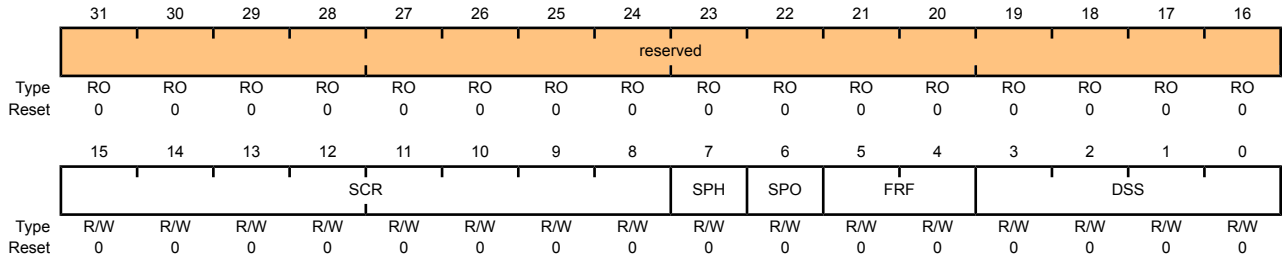

Bit/Field	Name	Type	Reset	Description
31:16	reserved	RO	0x00	Software should not rely on the value of a reserved bit. To provide compatibility with future products, the value of a reserved bit should be preserved across a read-modify-write operation.
15:8	SCR	R/W	0x0000	SSI Serial Clock Rate The value <i>SCR</i> is used to generate the transmit and receive bit rate of the SSI. The bit rate is: $BR = FSSIClk / (CPSDVSR * (1 + SCR))$ where <i>CPSDVSR</i> is an even value from 2-254 programmed in the SSICPSR register, and <i>SCR</i> is a value from 0-255.
7	SPH	R/W	0	SSI Serial Clock Phase This bit is only applicable to the Freescale SPI Format. The <i>SPH</i> control bit selects the clock edge that captures data and allows it to change state. It has the most impact on the first bit transmitted by either allowing or not allowing a clock transition before the first data capture edge. When the <i>SPH</i> bit is 0, data is captured on the first clock edge transition. If <i>SPH</i> is 1, data is captured on the second clock edge transition.
6	SPO	R/W	0	SSI Serial Clock Polarity This bit is only applicable to the Freescale SPI Format. When the <i>SPO</i> bit is 0, it produces a steady state Low value on the <i>SSIClk</i> pin. If <i>SPO</i> is 1, a steady state High value is placed on the <i>SSIClk</i> pin when data is not being transferred.

Bit/Field	Name	Type	Reset	Description
5:4	FRF	R/W	0x0	<p>SSI Frame Format Select</p> <p>The FRF values are defined as follows:</p> <p>Value Frame Format</p> <p>0x0 Freescale SPI Frame Format</p> <p>0x1 Texas Instruments Synchronous Serial Frame Format</p> <p>0x2 MICROWIRE Frame Format</p> <p>0x3 Reserved</p>
3:0	DSS	R/W	0x00	<p>SSI Data Size Select</p> <p>The DSS values are defined as follows:</p> <p>Value Data Size</p> <p>0x0-0x2 Reserved</p> <p>0x3 4-bit data</p> <p>0x4 5-bit data</p> <p>0x5 6-bit data</p> <p>0x6 7-bit data</p> <p>0x7 8-bit data</p> <p>0x8 9-bit data</p> <p>0x9 10-bit data</p> <p>0xA 11-bit data</p> <p>0xB 12-bit data</p> <p>0xC 13-bit data</p> <p>0xD 14-bit data</p> <p>0xE 15-bit data</p> <p>0xF 16-bit data</p>

Register 2: SSI Control 1 (SSICR1), offset 0x004

SSICR1 is control register 1 and contains bit fields that control various functions within the SSI module. Master and slave mode functionality is controlled by this register.

SSI Control 1 (SSICR1)

SSI0 base: 0x4000.8000
Offset 0x004
Type R/W, reset 0x0000.0000

	31	30	29	28	27	26	25	24	23	22	21	20	19	18	17	16	
	reserved																
Type	RO	RO	RO	RO	RO	RO	RO	RO	RO	RO	RO	RO	RO	RO	RO	RO	
Reset	0	0	0	0	0	0	0	0	0	0	0	0	0	0	0	0	
	15	14	13	12	11	10	9	8	7	6	5	4	3	2	1	0	
	reserved												SOD	MS	SSE	LBM	
Type	RO	RO	RO	RO	RO	RO	RO	RO	RO	RO	RO	RO	RO	R/W	R/W	R/W	R/W
Reset	0	0	0	0	0	0	0	0	0	0	0	0	0	0	0	0	0

Bit/Field	Name	Type	Reset	Description
31:4	reserved	RO	0x00	Software should not rely on the value of a reserved bit. To provide compatibility with future products, the value of a reserved bit should be preserved across a read-modify-write operation.

3	SOD	R/W	0	SSI Slave Mode Output Disable This bit is relevant only in the Slave mode ($MS=1$). In multiple-slave systems, it is possible for the SSI master to broadcast a message to all slaves in the system while ensuring that only one slave drives data onto the serial output line. In such systems, the TXD lines from multiple slaves could be tied together. To operate in such a system, the SOD bit can be configured so that the SSI slave does not drive the $SSITx$ pin.
---	-----	-----	---	---

The SOD values are defined as follows:

Value	Description
0	SSI can drive $SSITx$ output in Slave Output mode.
1	SSI must not drive the $SSITx$ output in Slave mode.

2	MS	R/W	0	SSI Master/Slave Select This bit selects Master or Slave mode and can be modified only when SSI is disabled ($SSE=0$).
---	----	-----	---	---

The MS values are defined as follows:

Value	Description
0	Device configured as a master.
1	Device configured as a slave.

Bit/Field	Name	Type	Reset	Description						
1	SSE	R/W	0	<p>SSI Synchronous Serial Port Enable</p> <p>Setting this bit enables SSI operation.</p> <p>The <code>SSE</code> values are defined as follows:</p> <table border="1"> <thead> <tr> <th>Value</th> <th>Description</th> </tr> </thead> <tbody> <tr> <td>0</td> <td>SSI operation disabled.</td> </tr> <tr> <td>1</td> <td>SSI operation enabled.</td> </tr> </tbody> </table> <p>Note: This bit must be set to 0 before any control registers are reprogrammed.</p>	Value	Description	0	SSI operation disabled.	1	SSI operation enabled.
Value	Description									
0	SSI operation disabled.									
1	SSI operation enabled.									
0	LBM	R/W	0	<p>SSI Loopback Mode</p> <p>Setting this bit enables Loopback Test mode.</p> <p>The <code>LBM</code> values are defined as follows:</p> <table border="1"> <thead> <tr> <th>Value</th> <th>Description</th> </tr> </thead> <tbody> <tr> <td>0</td> <td>Normal serial port operation enabled.</td> </tr> <tr> <td>1</td> <td>Output of the transmit serial shift register is connected internally to the input of the receive serial shift register.</td> </tr> </tbody> </table>	Value	Description	0	Normal serial port operation enabled.	1	Output of the transmit serial shift register is connected internally to the input of the receive serial shift register.
Value	Description									
0	Normal serial port operation enabled.									
1	Output of the transmit serial shift register is connected internally to the input of the receive serial shift register.									

Register 3: SSI Data (SSIDR), offset 0x008

SSIDR is the data register and is 16-bits wide. When **SSIDR** is read, the entry in the receive FIFO (pointed to by the current FIFO read pointer) is accessed. As data values are removed by the SSI receive logic from the incoming data frame, they are placed into the entry in the receive FIFO (pointed to by the current FIFO write pointer).

When **SSIDR** is written to, the entry in the transmit FIFO (pointed to by the write pointer) is written to. Data values are removed from the transmit FIFO one value at a time by the transmit logic. It is loaded into the transmit serial shifter, then serially shifted out onto the **SSITx** pin at the programmed bit rate.

When a data size of less than 16 bits is selected, the user must right-justify data written to the transmit FIFO. The transmit logic ignores the unused bits. Received data less than 16 bits is automatically right-justified in the receive buffer.

When the SSI is programmed for MICROWIRE frame format, the default size for transmit data is eight bits (the most significant byte is ignored). The receive data size is controlled by the programmer. The transmit FIFO and the receive FIFO are not cleared even when the **SSE** bit in the **SSICR1** register is set to zero. This allows the software to fill the transmit FIFO before enabling the SSI.

SSI Data (SSIDR)

SSI0 base: 0x4000.8000
Offset 0x008
Type R/W, reset 0x0000.0000

	31	30	29	28	27	26	25	24	23	22	21	20	19	18	17	16
	reserved															
Type	RO	RO	RO	RO	RO	RO	RO	RO	RO	RO	RO	RO	RO	RO	RO	RO
Reset	0	0	0	0	0	0	0	0	0	0	0	0	0	0	0	0
	15	14	13	12	11	10	9	8	7	6	5	4	3	2	1	0
	DATA															
Type	R/W	R/W	R/W	R/W	R/W	R/W	R/W	R/W	R/W	R/W	R/W	R/W	R/W	R/W	R/W	R/W
Reset	0	0	0	0	0	0	0	0	0	0	0	0	0	0	0	0

Bit/Field	Name	Type	Reset	Description
31:16	reserved	RO	0x0000	Software should not rely on the value of a reserved bit. To provide compatibility with future products, the value of a reserved bit should be preserved across a read-modify-write operation.
15:0	DATA	R/W	0x0000	SSI Receive/Transmit Data A read operation reads the receive FIFO. A write operation writes the transmit FIFO. Software must right-justify data when the SSI is programmed for a data size that is less than 16 bits. Unused bits at the top are ignored by the transmit logic. The receive logic automatically right-justifies the data.

Register 4: SSI Status (SSISR), offset 0x00C

SSISR is a status register that contains bits that indicate the FIFO fill status and the SSI busy status.

SSI Status (SSISR)

SSI0 base: 0x4000.8000
 Offset 0x00C
 Type RO, reset 0x0000.0003

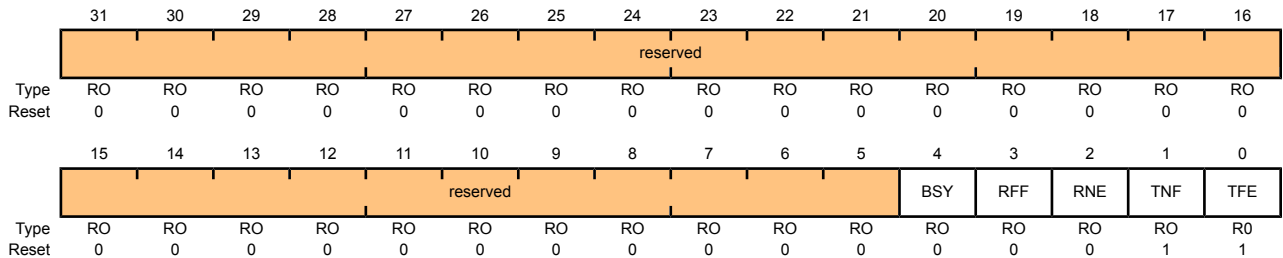

Bit/Field	Name	Type	Reset	Description
31:5	reserved	RO	0x00	Software should not rely on the value of a reserved bit. To provide compatibility with future products, the value of a reserved bit should be preserved across a read-modify-write operation.
4	BSY	RO	0	SSI Busy Bit The BSY values are defined as follows: Value Description 0 SSI is idle. 1 SSI is currently transmitting and/or receiving a frame, or the transmit FIFO is not empty.
3	RFF	RO	0	SSI Receive FIFO Full The RFF values are defined as follows: Value Description 0 Receive FIFO is not full. 1 Receive FIFO is full.
2	RNE	RO	0	SSI Receive FIFO Not Empty The RNE values are defined as follows: Value Description 0 Receive FIFO is empty. 1 Receive FIFO is not empty.
1	TNF	RO	1	SSI Transmit FIFO Not Full The TNF values are defined as follows: Value Description 0 Transmit FIFO is full. 1 Transmit FIFO is not full.

Bit/Field	Name	Type	Reset	Description
0	TFE	R0	1	SSI Transmit FIFO Empty The TFE values are defined as follows: Value Description 0 Transmit FIFO is not empty. 1 Transmit FIFO is empty.

Register 5: SSI Clock Prescale (SSICPSR), offset 0x010

SSICPSR is the clock prescale register and specifies the division factor by which the system clock must be internally divided before further use.

The value programmed into this register must be an even number between 2 and 254. The least-significant bit of the programmed number is hard-coded to zero. If an odd number is written to this register, data read back from this register has the least-significant bit as zero.

SSI Clock Prescale (SSICPSR)

SSI0 base: 0x4000.8000
 Offset 0x010
 Type R/W, reset 0x0000.0000

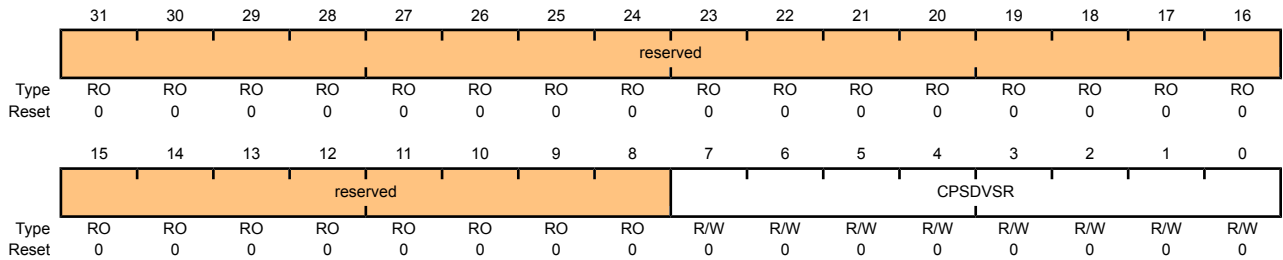

Bit/Field	Name	Type	Reset	Description
31:8	reserved	RO	0x00	Software should not rely on the value of a reserved bit. To provide compatibility with future products, the value of a reserved bit should be preserved across a read-modify-write operation.
7:0	CPSDVSR	R/W	0x00	SSI Clock Prescale Divisor This value must be an even number from 2 to 254, depending on the frequency of SSI0CLK. The LSB always returns 0 on reads.

Register 6: SSI Interrupt Mask (SSIIM), offset 0x014

The **SSIIM** register is the interrupt mask set or clear register. It is a read/write register and all bits are cleared to 0 on reset.

On a read, this register gives the current value of the mask on the relevant interrupt. A write of 1 to the particular bit sets the mask, enabling the interrupt to be read. A write of 0 clears the corresponding mask.

SSI Interrupt Mask (SSIIM)

SSI0 base: 0x4000.8000
Offset 0x014
Type R/W, reset 0x0000.0000

	31	30	29	28	27	26	25	24	23	22	21	20	19	18	17	16	
	reserved																
Type	RO	RO	RO	RO	RO	RO	RO	RO	RO	RO	RO	RO	RO	RO	RO	RO	
Reset	0	0	0	0	0	0	0	0	0	0	0	0	0	0	0	0	
	15	14	13	12	11	10	9	8	7	6	5	4	3	2	1	0	
	reserved												TXIM	RXIM	RTIM	RORIM	
Type	RO	RO	RO	RO	RO	RO	RO	RO	RO	RO	RO	RO	RO	R/W	R/W	R/W	R/W
Reset	0	0	0	0	0	0	0	0	0	0	0	0	0	0	0	0	0

Bit/Field	Name	Type	Reset	Description
31:4	reserved	RO	0x00	Software should not rely on the value of a reserved bit. To provide compatibility with future products, the value of a reserved bit should be preserved across a read-modify-write operation.
3	TXIM	R/W	0	SSI Transmit FIFO Interrupt Mask The TXIM values are defined as follows: Value Description 0 TX FIFO half-full or less condition interrupt is masked. 1 TX FIFO half-full or less condition interrupt is not masked.
2	RXIM	R/W	0	SSI Receive FIFO Interrupt Mask The RXIM values are defined as follows: Value Description 0 RX FIFO half-full or more condition interrupt is masked. 1 RX FIFO half-full or more condition interrupt is not masked.
1	RTIM	R/W	0	SSI Receive Time-Out Interrupt Mask The RTIM values are defined as follows: Value Description 0 RX FIFO time-out interrupt is masked. 1 RX FIFO time-out interrupt is not masked.

Bit/Field	Name	Type	Reset	Description
0	RORIM	R/W	0	SSI Receive Overrun Interrupt Mask The RORIM values are defined as follows: Value Description 0 RX FIFO overrun interrupt is masked. 1 RX FIFO overrun interrupt is not masked.

Register 7: SSI Raw Interrupt Status (SSIRIS), offset 0x018

The **SSIRIS** register is the raw interrupt status register. On a read, this register gives the current raw status value of the corresponding interrupt prior to masking. A write has no effect.

SSI Raw Interrupt Status (SSIRIS)

SSI0 base: 0x4000.8000
 Offset 0x018
 Type RO, reset 0x0000.0008

	31	30	29	28	27	26	25	24	23	22	21	20	19	18	17	16
	reserved															
Type	RO	RO	RO	RO	RO	RO	RO	RO	RO	RO	RO	RO	RO	RO	RO	RO
Reset	0	0	0	0	0	0	0	0	0	0	0	0	0	0	0	0
	15	14	13	12	11	10	9	8	7	6	5	4	3	2	1	0
	reserved												TXRIS	RXRIS	RTRIS	RORRIS
Type	RO	RO	RO	RO	RO	RO	RO	RO	RO	RO	RO	RO	RO	RO	RO	RO
Reset	0	0	0	0	0	0	0	0	0	0	0	0	1	0	0	0

Bit/Field	Name	Type	Reset	Description
31:4	reserved	RO	0x00	Software should not rely on the value of a reserved bit. To provide compatibility with future products, the value of a reserved bit should be preserved across a read-modify-write operation.
3	TXRIS	RO	1	SSI Transmit FIFO Raw Interrupt Status Indicates that the transmit FIFO is half full or less, when set.
2	RXRIS	RO	0	SSI Receive FIFO Raw Interrupt Status Indicates that the receive FIFO is half full or more, when set.
1	RTRIS	RO	0	SSI Receive Time-Out Raw Interrupt Status Indicates that the receive time-out has occurred, when set.
0	RORRIS	RO	0	SSI Receive Overrun Raw Interrupt Status Indicates that the receive FIFO has overflowed, when set.

Register 8: SSI Masked Interrupt Status (SSIMIS), offset 0x01C

The **SSIMIS** register is the masked interrupt status register. On a read, this register gives the current masked status value of the corresponding interrupt. A write has no effect.

SSI Masked Interrupt Status (SSIMIS)

SSI0 base: 0x4000.8000
Offset 0x01C
Type RO, reset 0x0000.0000

	31	30	29	28	27	26	25	24	23	22	21	20	19	18	17	16	
	reserved																
Type	RO	RO	RO	RO	RO	RO	RO	RO	RO	RO	RO	RO	RO	RO	RO	RO	
Reset	0	0	0	0	0	0	0	0	0	0	0	0	0	0	0	0	
	15	14	13	12	11	10	9	8	7	6	5	4	3	2	1	0	
	reserved													TXMIS	RXMIS	RTMIS	RORMIS
Type	RO	RO	RO	RO	RO	RO	RO	RO	RO	RO	RO	RO	RO	RO	RO	RO	
Reset	0	0	0	0	0	0	0	0	0	0	0	0	0	0	0	0	

Bit/Field	Name	Type	Reset	Description
31:4	reserved	RO	0	Software should not rely on the value of a reserved bit. To provide compatibility with future products, the value of a reserved bit should be preserved across a read-modify-write operation.
3	TXMIS	RO	0	SSI Transmit FIFO Masked Interrupt Status Indicates that the transmit FIFO is half full or less, when set.
2	RXMIS	RO	0	SSI Receive FIFO Masked Interrupt Status Indicates that the receive FIFO is half full or more, when set.
1	RTMIS	RO	0	SSI Receive Time-Out Masked Interrupt Status Indicates that the receive time-out has occurred, when set.
0	RORMIS	RO	0	SSI Receive Overrun Masked Interrupt Status Indicates that the receive FIFO has overflowed, when set.

Register 9: SSI Interrupt Clear (SSIICR), offset 0x020

The **SSIICR** register is the interrupt clear register. On a write of 1, the corresponding interrupt is cleared. A write of 0 has no effect.

SSI Interrupt Clear (SSIICR)

SSI0 base: 0x4000.8000
 Offset 0x020
 Type W1C, reset 0x0000.0000

	31	30	29	28	27	26	25	24	23	22	21	20	19	18	17	16	
	reserved																
Type	RO	RO	RO	RO	RO	RO	RO	RO	RO	RO	RO	RO	RO	RO	RO	RO	
Reset	0	0	0	0	0	0	0	0	0	0	0	0	0	0	0	0	
	15	14	13	12	11	10	9	8	7	6	5	4	3	2	1	0	
	reserved														RTIC	RORIC	
Type	RO	RO	RO	RO	RO	RO	RO	RO	RO	RO	RO	RO	RO	RO	RO	W1C	W1C
Reset	0	0	0	0	0	0	0	0	0	0	0	0	0	0	0	0	0

Bit/Field	Name	Type	Reset	Description
31:2	reserved	RO	0x00	Software should not rely on the value of a reserved bit. To provide compatibility with future products, the value of a reserved bit should be preserved across a read-modify-write operation.
1	RTIC	W1C	0	SSI Receive Time-Out Interrupt Clear The RTIC values are defined as follows: Value Description 0 No effect on interrupt. 1 Clears interrupt.
0	RORIC	W1C	0	SSI Receive Overrun Interrupt Clear The RORIC values are defined as follows: Value Description 0 No effect on interrupt. 1 Clears interrupt.

Register 10: SSI Peripheral Identification 4 (SSIPeriphID4), offset 0xFD0

The **SSIPeriphIDn** registers are hard-coded and the fields within the register determine the reset value.

SSI Peripheral Identification 4 (SSIPeriphID4)

SSI0 base: 0x4000.8000

Offset 0xFD0

Type RO, reset 0x0000.0000

	31	30	29	28	27	26	25	24	23	22	21	20	19	18	17	16
	reserved															
Type	RO	RO	RO	RO	RO	RO	RO	RO	RO	RO	RO	RO	RO	RO	RO	RO
Reset	0	0	0	0	0	0	0	0	0	0	0	0	0	0	0	0
	15	14	13	12	11	10	9	8	7	6	5	4	3	2	1	0
	reserved								PID4							
Type	RO	RO	RO	RO	RO	RO	RO	RO	RO	RO	RO	RO	RO	RO	RO	RO
Reset	0	0	0	0	0	0	0	0	0	0	0	0	0	0	0	0

Bit/Field	Name	Type	Reset	Description
31:8	reserved	RO	0x00	Software should not rely on the value of a reserved bit. To provide compatibility with future products, the value of a reserved bit should be preserved across a read-modify-write operation.
7:0	PID4	RO	0x00	SSI Peripheral ID Register[7:0] Can be used by software to identify the presence of this peripheral.

Register 11: SSI Peripheral Identification 5 (SSIPeriphID5), offset 0xFD4

The **SSIPeriphIDn** registers are hard-coded and the fields within the register determine the reset value.

SSI Peripheral Identification 5 (SSIPeriphID5)

SSI0 base: 0x4000.8000
 Offset 0xFD4
 Type RO, reset 0x0000.0000

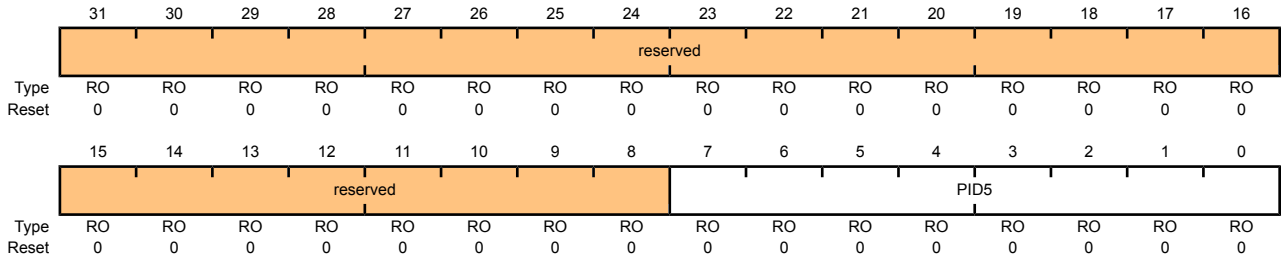

Bit/Field	Name	Type	Reset	Description
31:8	reserved	RO	0x00	Software should not rely on the value of a reserved bit. To provide compatibility with future products, the value of a reserved bit should be preserved across a read-modify-write operation.
7:0	PID5	RO	0x00	SSI Peripheral ID Register[15:8] Can be used by software to identify the presence of this peripheral.

Register 12: SSI Peripheral Identification 6 (SSIPeriphID6), offset 0xFD8

The **SSIPeriphIDn** registers are hard-coded and the fields within the register determine the reset value.

SSI Peripheral Identification 6 (SSIPeriphID6)

SSI0 base: 0x4000.8000

Offset 0xFD8

Type RO, reset 0x0000.0000

	31	30	29	28	27	26	25	24	23	22	21	20	19	18	17	16
	reserved															
Type	RO	RO	RO	RO	RO	RO	RO	RO	RO	RO	RO	RO	RO	RO	RO	RO
Reset	0	0	0	0	0	0	0	0	0	0	0	0	0	0	0	0
	15	14	13	12	11	10	9	8	7	6	5	4	3	2	1	0
	reserved								PID6							
Type	RO	RO	RO	RO	RO	RO	RO	RO	RO	RO	RO	RO	RO	RO	RO	RO
Reset	0	0	0	0	0	0	0	0	0	0	0	0	0	0	0	0

Bit/Field	Name	Type	Reset	Description
31:8	reserved	RO	0x00	Software should not rely on the value of a reserved bit. To provide compatibility with future products, the value of a reserved bit should be preserved across a read-modify-write operation.
7:0	PID6	RO	0x00	SSI Peripheral ID Register[23:16] Can be used by software to identify the presence of this peripheral.

Register 13: SSI Peripheral Identification 7 (SSIPeriphID7), offset 0xFDC

The **SSIPeriphIDn** registers are hard-coded and the fields within the register determine the reset value.

SSI Peripheral Identification 7 (SSIPeriphID7)

SSI0 base: 0x4000.8000
 Offset 0xFDC
 Type RO, reset 0x0000.0000

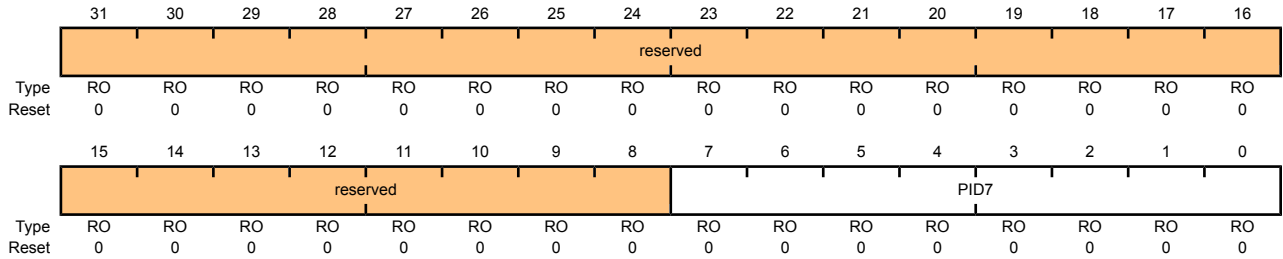

Bit/Field	Name	Type	Reset	Description
31:8	reserved	RO	0x00	Software should not rely on the value of a reserved bit. To provide compatibility with future products, the value of a reserved bit should be preserved across a read-modify-write operation.
7:0	PID7	RO	0x00	SSI Peripheral ID Register[31:24] Can be used by software to identify the presence of this peripheral.

Register 14: SSI Peripheral Identification 0 (SSIPeriphID0), offset 0xFE0

The **SSIPeriphIDn** registers are hard-coded and the fields within the register determine the reset value.

SSI Peripheral Identification 0 (SSIPeriphID0)

SSI0 base: 0x4000.8000

Offset 0xFE0

Type RO, reset 0x0000.0022

	31	30	29	28	27	26	25	24	23	22	21	20	19	18	17	16
	reserved															
Type	RO	RO	RO	RO	RO	RO	RO	RO	RO	RO	RO	RO	RO	RO	RO	RO
Reset	0	0	0	0	0	0	0	0	0	0	0	0	0	0	0	0
	15	14	13	12	11	10	9	8	7	6	5	4	3	2	1	0
	reserved								PID0							
Type	RO	RO	RO	RO	RO	RO	RO	RO	RO	RO	RO	RO	RO	RO	RO	RO
Reset	0	0	0	0	0	0	0	0	0	0	1	0	0	0	1	0

Bit/Field	Name	Type	Reset	Description
31:8	reserved	RO	0	Software should not rely on the value of a reserved bit. To provide compatibility with future products, the value of a reserved bit should be preserved across a read-modify-write operation.
7:0	PID0	RO	0x22	SSI Peripheral ID Register[7:0] Can be used by software to identify the presence of this peripheral.

Register 15: SSI Peripheral Identification 1 (SSIPeriphID1), offset 0xFE4

The **SSIPeriphIDn** registers are hard-coded and the fields within the register determine the reset value.

SSI Peripheral Identification 1 (SSIPeriphID1)

SSI0 base: 0x4000.8000
 Offset 0xFE4
 Type RO, reset 0x0000.0000

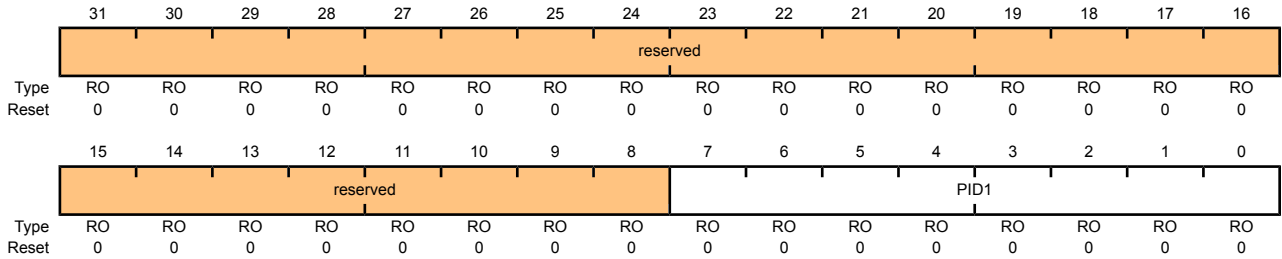

Bit/Field	Name	Type	Reset	Description
31:8	reserved	RO	0x00	Software should not rely on the value of a reserved bit. To provide compatibility with future products, the value of a reserved bit should be preserved across a read-modify-write operation.
7:0	PID1	RO	0x00	SSI Peripheral ID Register [15:8] Can be used by software to identify the presence of this peripheral.

Register 16: SSI Peripheral Identification 2 (SSIPeriphID2), offset 0xFE8

The **SSIPeriphIDn** registers are hard-coded and the fields within the register determine the reset value.

SSI Peripheral Identification 2 (SSIPeriphID2)

SSI0 base: 0x4000.8000

Offset 0xFE8

Type RO, reset 0x0000.0018

	31	30	29	28	27	26	25	24	23	22	21	20	19	18	17	16
	reserved															
Type	RO	RO	RO	RO	RO	RO	RO	RO	RO	RO	RO	RO	RO	RO	RO	RO
Reset	0	0	0	0	0	0	0	0	0	0	0	0	0	0	0	0
	15	14	13	12	11	10	9	8	7	6	5	4	3	2	1	0
	reserved								PID2							
Type	RO	RO	RO	RO	RO	RO	RO	RO	RO	RO	RO	RO	RO	RO	RO	RO
Reset	0	0	0	0	0	0	0	0	0	0	0	1	1	0	0	0

Bit/Field	Name	Type	Reset	Description
31:8	reserved	RO	0x00	Software should not rely on the value of a reserved bit. To provide compatibility with future products, the value of a reserved bit should be preserved across a read-modify-write operation.
7:0	PID2	RO	0x18	SSI Peripheral ID Register [23:16] Can be used by software to identify the presence of this peripheral.

Register 17: SSI Peripheral Identification 3 (SSIPeriphID3), offset 0xFEC

The **SSIPeriphIDn** registers are hard-coded and the fields within the register determine the reset value.

SSI Peripheral Identification 3 (SSIPeriphID3)

SSI0 base: 0x4000.8000

Offset 0xFEC

Type RO, reset 0x0000.0001

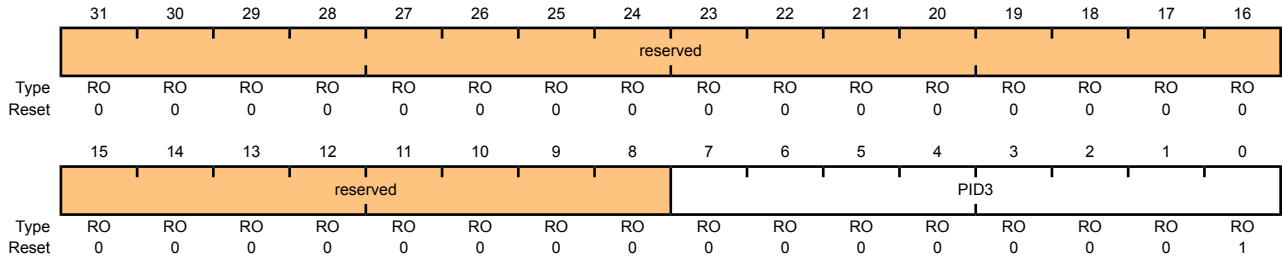

Bit/Field	Name	Type	Reset	Description
31:8	reserved	RO	0x00	Software should not rely on the value of a reserved bit. To provide compatibility with future products, the value of a reserved bit should be preserved across a read-modify-write operation.
7:0	PID3	RO	0x01	SSI Peripheral ID Register [31:24] Can be used by software to identify the presence of this peripheral.

Register 18: SSI PrimeCell Identification 0 (SSIPCellID0), offset 0xFF0

The **SSIPCellIDn** registers are hard-coded and the fields within the register determine the reset value.

SSI PrimeCell Identification 0 (SSIPCellID0)

SSI0 base: 0x4000.8000
Offset 0xFF0
Type RO, reset 0x0000.000D

	31	30	29	28	27	26	25	24	23	22	21	20	19	18	17	16
	reserved															
Type	RO	RO	RO	RO	RO	RO	RO	RO	RO	RO	RO	RO	RO	RO	RO	RO
Reset	0	0	0	0	0	0	0	0	0	0	0	0	0	0	0	0
	15	14	13	12	11	10	9	8	7	6	5	4	3	2	1	0
	reserved								CID0							
Type	RO	RO	RO	RO	RO	RO	RO	RO	RO	RO	RO	RO	RO	RO	RO	RO
Reset	0	0	0	0	0	0	0	0	0	0	0	0	1	1	0	1

Bit/Field	Name	Type	Reset	Description
31:8	reserved	RO	0x00	Software should not rely on the value of a reserved bit. To provide compatibility with future products, the value of a reserved bit should be preserved across a read-modify-write operation.
7:0	CID0	RO	0x0D	SSI PrimeCell ID Register [7:0] Provides software a standard cross-peripheral identification system.

Register 19: SSI PrimeCell Identification 1 (SSIPCellID1), offset 0xFF4

The **SSIPCellIDn** registers are hard-coded and the fields within the register determine the reset value.

SSI PrimeCell Identification 1 (SSIPCellID1)

SSI0 base: 0x4000.8000
 Offset 0xFF4
 Type RO, reset 0x0000.00F0

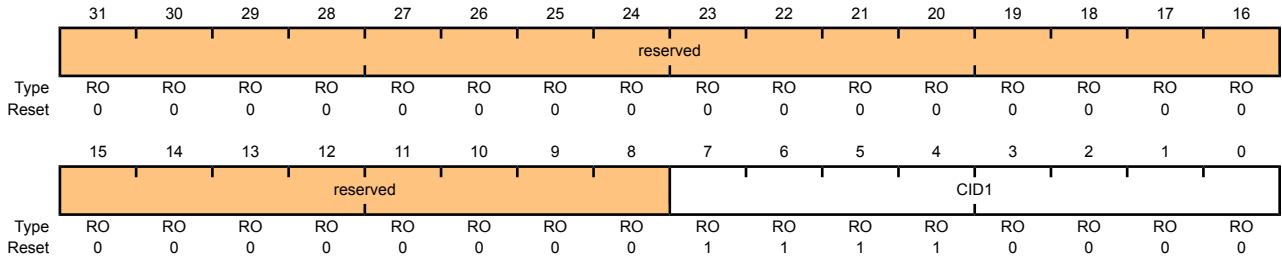

Bit/Field	Name	Type	Reset	Description
31:8	reserved	RO	0x00	Software should not rely on the value of a reserved bit. To provide compatibility with future products, the value of a reserved bit should be preserved across a read-modify-write operation.
7:0	CID1	RO	0xF0	SSI PrimeCell ID Register [15:8] Provides software a standard cross-peripheral identification system.

Register 20: SSI PrimeCell Identification 2 (SSIPCellID2), offset 0xFF8

The **SSIPCellIDn** registers are hard-coded and the fields within the register determine the reset value.

SSI PrimeCell Identification 2 (SSIPCellID2)

SSI0 base: 0x4000.8000

Offset 0xFF8

Type RO, reset 0x0000.0005

	31	30	29	28	27	26	25	24	23	22	21	20	19	18	17	16
	reserved															
Type	RO	RO	RO	RO	RO	RO	RO	RO	RO	RO	RO	RO	RO	RO	RO	RO
Reset	0	0	0	0	0	0	0	0	0	0	0	0	0	0	0	0
	15	14	13	12	11	10	9	8	7	6	5	4	3	2	1	0
	reserved								CID2							
Type	RO	RO	RO	RO	RO	RO	RO	RO	RO	RO	RO	RO	RO	RO	RO	RO
Reset	0	0	0	0	0	0	0	0	0	0	0	0	0	0	1	0

Bit/Field	Name	Type	Reset	Description
31:8	reserved	RO	0x00	Software should not rely on the value of a reserved bit. To provide compatibility with future products, the value of a reserved bit should be preserved across a read-modify-write operation.
7:0	CID2	RO	0x05	SSI PrimeCell ID Register [23:16] Provides software a standard cross-peripheral identification system.

Register 21: SSI PrimeCell Identification 3 (SSIPCellID3), offset 0xFFC

The **SSIPCellIDn** registers are hard-coded and the fields within the register determine the reset value.

SSI PrimeCell Identification 3 (SSIPCellID3)

SSI0 base: 0x4000.8000
 Offset 0xFFC
 Type RO, reset 0x0000.00B1

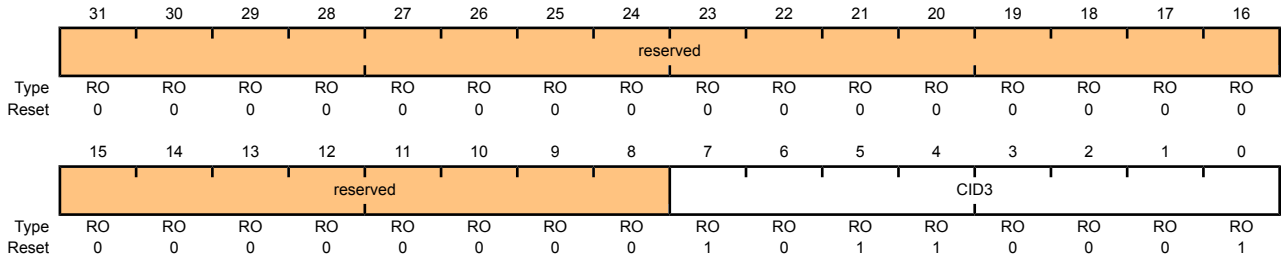

Bit/Field	Name	Type	Reset	Description
31:8	reserved	RO	0x00	Software should not rely on the value of a reserved bit. To provide compatibility with future products, the value of a reserved bit should be preserved across a read-modify-write operation.
7:0	CID3	RO	0xB1	SSI PrimeCell ID Register [31:24] Provides software a standard cross-peripheral identification system.

14 Inter-Integrated Circuit (I²C) Interface

The Inter-Integrated Circuit (I²C) bus provides bi-directional data transfer through a two-wire design (a serial data line SDA and a serial clock line SCL), and interfaces to external I²C devices such as serial memory (RAMs and ROMs), networking devices, LCDs, tone generators, and so on. The I²C bus may also be used for system testing and diagnostic purposes in product development and manufacture. The LM3S828 microcontroller includes one I²C module, providing the ability to interact (both send and receive) with other I²C devices on the bus.

Devices on the I²C bus can be designated as either a master or a slave. The Stellaris[®] I²C module supports both sending and receiving data as either a master or a slave, and also supports the simultaneous operation as both a master and a slave. There are a total of four I²C modes: Master Transmit, Master Receive, Slave Transmit, and Slave Receive. The Stellaris[®] I²C module can operate at two speeds: Standard (100 Kbps) and Fast (400 Kbps).

Both the I²C master and slave can generate interrupts; the I²C master generates interrupts when a transmit or receive operation completes (or aborts due to an error) and the I²C slave generates interrupts when data has been sent or requested by a master.

14.1 Block Diagram

Figure 14-1. I²C Block Diagram

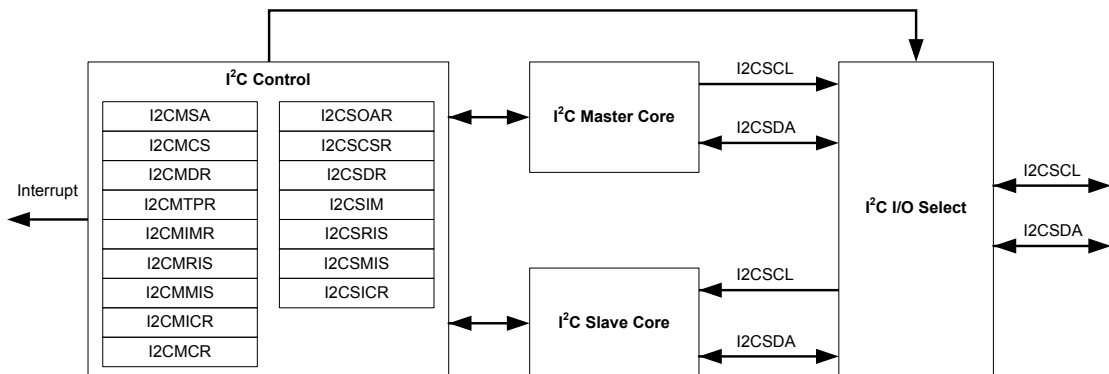

14.2 Functional Description

I²C module is comprised of both master and slave functions which are implemented as separate peripherals. For proper operation, the SDA and SCL pins must be connected to bi-directional open-drain pads. A typical I²C bus configuration is shown in Figure 14-2 on page 332.

See "I²C" on page 377 for I²C timing diagrams.

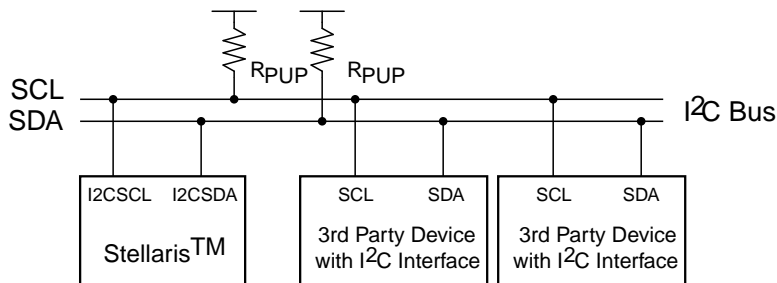
Figure 14-2. I²C Bus Configuration

14.2.1 I²C Bus Functional Overview

The I²C bus uses only two signals: SDA and SCL, named I2CSDA and I2CSCL on Stellaris[®] microcontrollers. SDA is the bi-directional serial data line and SCL is the bi-directional serial clock line. The bus is considered idle when both lines are high.

Every transaction on the I²C bus is nine bits long, consisting of eight data bits and a single acknowledge bit. The number of bytes per transfer (defined as the time between a valid START and STOP condition, described in “START and STOP Conditions” on page 332) is unrestricted, but each byte has to be followed by an acknowledge bit, and data must be transferred MSB first. When a receiver cannot receive another complete byte, it can hold the clock line SCL Low and force the transmitter into a wait state. The data transfer continues when the receiver releases the clock SCL.

14.2.1.1 START and STOP Conditions

The protocol of the I²C bus defines two states to begin and end a transaction: START and STOP. A high-to-low transition on the SDA line while the SCL is high is defined as a START condition, and a low-to-high transition on the SDA line while SCL is high is defined as a STOP condition. The bus is considered busy after a START condition and free after a STOP condition. See Figure 14-3 on page 332.

Figure 14-3. START and STOP Conditions

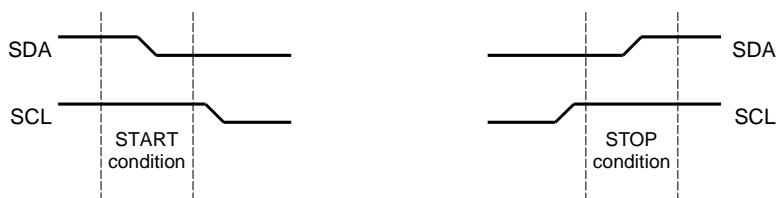

14.2.1.2 Data Format with 7-Bit Address

Data transfers follow the format shown in Figure 14-4 on page 333. After the START condition, a slave address is sent. This address is 7-bits long followed by an eighth bit, which is a data direction bit (R/S bit in the I2CMSA register). A zero indicates a transmit operation (send), and a one indicates a request for data (receive). A data transfer is always terminated by a STOP condition generated by the master, however, a master can initiate communications with another device on the bus by generating a repeated START condition and addressing another slave without first generating a STOP condition. Various combinations of receive/send formats are then possible within a single transfer.

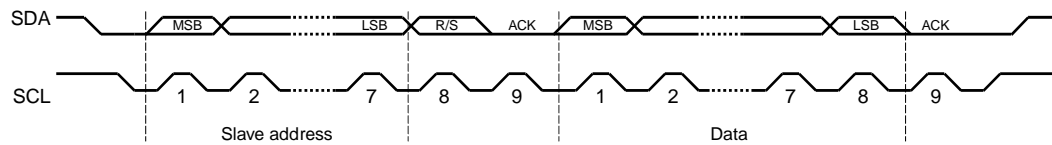
Figure 14-4. Complete Data Transfer with a 7-Bit Address

The first seven bits of the first byte make up the slave address (see Figure 14-5 on page 333). The eighth bit determines the direction of the message. A zero in the R/S position of the first byte means that the master will write (send) data to the selected slave, and a one in this position means that the master will receive data from the slave.

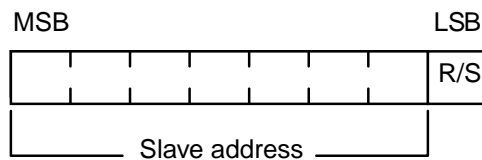
Figure 14-5. R/S Bit in First Byte

14.2.1.3 Data Validity

The data on the SDA line must be stable during the high period of the clock, and the data line can only change when SCL is low (see Figure 14-6 on page 333).

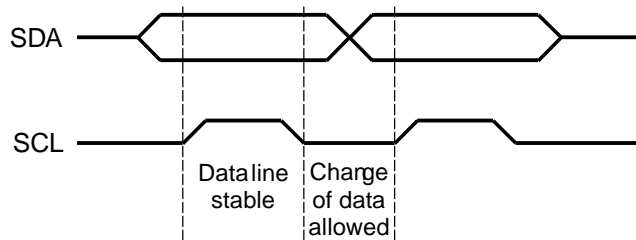
Figure 14-6. Data Validity During Bit Transfer on the I²C Bus

14.2.1.4 Acknowledge

All bus transactions have a required acknowledge clock cycle that is generated by the master. During the acknowledge cycle, the transmitter (which can be the master or slave) releases the SDA line. To acknowledge the transaction, the receiver must pull down SDA during the acknowledge clock cycle. The data sent out by the receiver during the acknowledge cycle must comply with the data validity requirements described in "Data Validity" on page 333.

When a slave receiver does not acknowledge the slave address, SDA must be left high by the slave so that the master can generate a STOP condition and abort the current transfer. If the master device is acting as a receiver during a transfer, it is responsible for acknowledging each transfer made by the slave. Since the master controls the number of bytes in the transfer, it signals the end of data to the slave transmitter by not generating an acknowledge on the last data byte. The slave transmitter must then release SDA to allow the master to generate the STOP or a repeated START condition.

14.2.1.5 Arbitration

A master may start a transfer only if the bus is idle. It's possible for two or more masters to generate a START condition within minimum hold time of the START condition. In these situations, an arbitration scheme takes place on the SDA line, while SCL is high. During arbitration, the first of the competing master devices to place a '1' (high) on SDA while another master transmits a '0' (low) will switch off its data output stage and retire until the bus is idle again.

Arbitration can take place over several bits. Its first stage is a comparison of address bits, and if both masters are trying to address the same device, arbitration continues on to the comparison of data bits.

14.2.2 Available Speed Modes

The I²C clock rate is determined by the parameters: CLK_PRD, TIMER_PRD, SCL_LP, and SCL_HP. where:

CLK_PRD is the system clock period

SCL_LP is the low phase of SCL (fixed at 6)

SCL_HP is the high phase of SCL (fixed at 4)

TIMER_PRD is the programmed value in the **I²C Master Timer Period (I2CMTPR)** register (see page 351).

The I²C clock period is calculated as follows:

$$SCL_PERIOD = 2 * (1 + TIMER_PRD) * (SCL_LP + SCL_HP) * CLK_PRD$$

For example:

CLK_PRD = 50 ns

TIMER_PRD = 2

SCL_LP=6

SCL_HP=4

yields a SCL frequency of:

$$1/T = 333 \text{ Khz}$$

Table 14-1 on page 334 gives examples of timer period, system clock, and speed mode (Standard or Fast).

Table 14-1. Examples of I²C Master Timer Period versus Speed Mode

System Clock	Timer Period	Standard Mode	Timer Period	Fast Mode
4 Mhz	0x01	100 Kbps	-	-
6 Mhz	0x02	100 Kbps	-	-
12.5 Mhz	0x06	89 Kbps	0x01	312 Kbps
16.7 Mhz	0x08	93 Kbps	0x02	278 Kbps
20 Mhz	0x09	100 Kbps	0x02	333 Kbps
25 Mhz	0x0C	96.2 Kbps	0x03	312 Kbps
33Mhz	0x10	97.1 Kbps	0x04	330 Kbps
40Mhz	0x13	100 Kbps	0x04	400 Kbps

System Clock	Timer Period	Standard Mode	Timer Period	Fast Mode
50Mhz	0x18	100 Kbps	0x06	357 Kbps

14.2.3 Interrupts

The I²C can generate interrupts when the following conditions are observed:

- Master transaction completed
- Master transaction error
- Slave transaction received
- Slave transaction requested

There is a separate interrupt signal for the I²C master and I²C slave modules. While both modules can generate interrupts for multiple conditions, only a single interrupt signal is sent to the interrupt controller.

14.2.3.1 I²C Master Interrupts

The I²C master module generates an interrupt when a transaction completes (either transmit or receive), or when an error occurs during a transaction. To enable the I²C master interrupt, software must write a '1' to the **I²C Master Interrupt Mask (I2CMIMR)** register. When an interrupt condition is met, software must check the **ERROR** bit in the **I²C Master Control/Status (I2CMCS)** register to verify that an error didn't occur during the last transaction. An error condition is asserted if the last transaction wasn't acknowledge by the slave or if the master was forced to give up ownership of the bus due to a lost arbitration round with another master. If an error is not detected, the application can proceed with the transfer. The interrupt is cleared by writing a '1' to the **I²C Master Interrupt Clear (I2CMICR)** register.

If the application doesn't require the use of interrupts, the raw interrupt status is always visible via the **I²C Master Raw Interrupt Status (I2CMRIS)** register.

14.2.3.2 I²C Slave Interrupts

The slave module generates interrupts as it receives requests from an I²C master. To enable the I²C slave interrupt, write a '1' to the **I²C Slave Interrupt Mask (I2CSIMR)** register. Software determines whether the module should write (transmit) or read (receive) data from the **I²C Slave Data (I2CSDR)** register, by checking the **RREQ** and **TREQ** bits of the **I²C Slave Control/Status (I2CSCSR)** register. If the slave module is in receive mode and the first byte of a transfer is received, the **FBR** bit is set along with the **RREQ** bit. The interrupt is cleared by writing a '1' to the **I²C Slave Interrupt Clear (I2CSICR)** register.

If the application doesn't require the use of interrupts, the raw interrupt status is always visible via the **I²C Slave Raw Interrupt Status (I2CSRIS)** register.

14.2.4 Loopback Operation

The I²C modules can be placed into an internal loopback mode for diagnostic or debug work. This is accomplished by setting the **LPBK** bit in the **I²C Master Configuration (I2CMCR)** register. In loopback mode, the SDA and SCL signals from the master and slave modules are tied together.

14.2.5 Command Sequence Flow Charts

This section details the steps required to perform the various I²C transfer types in both master and slave mode.

14.2.5.1 I²C Master Command Sequences

The figures that follow show the command sequences available for the I²C master.

Figure 14-7. Master Single SEND

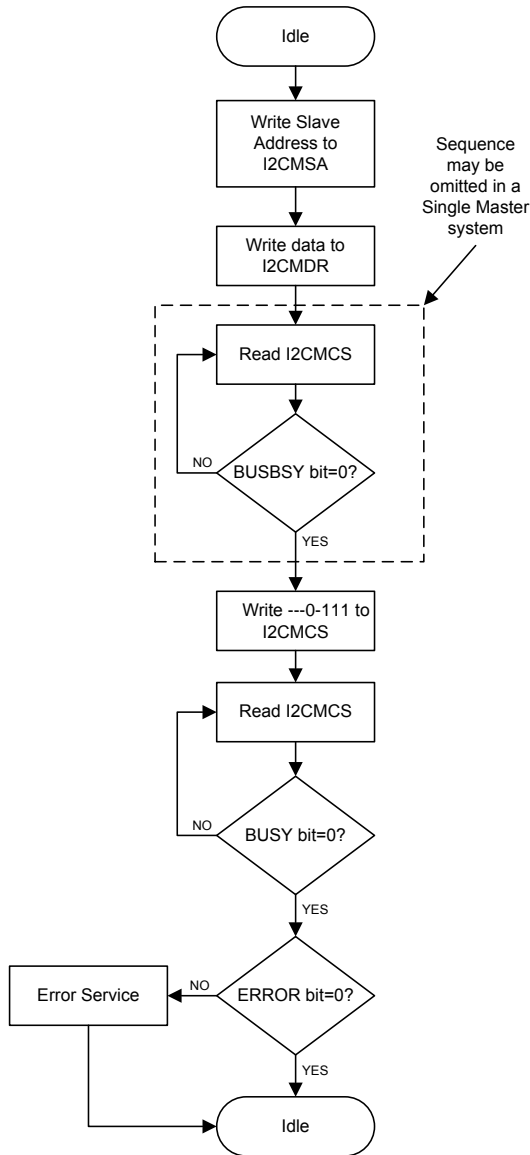

Figure 14-8. Master Single RECEIVE

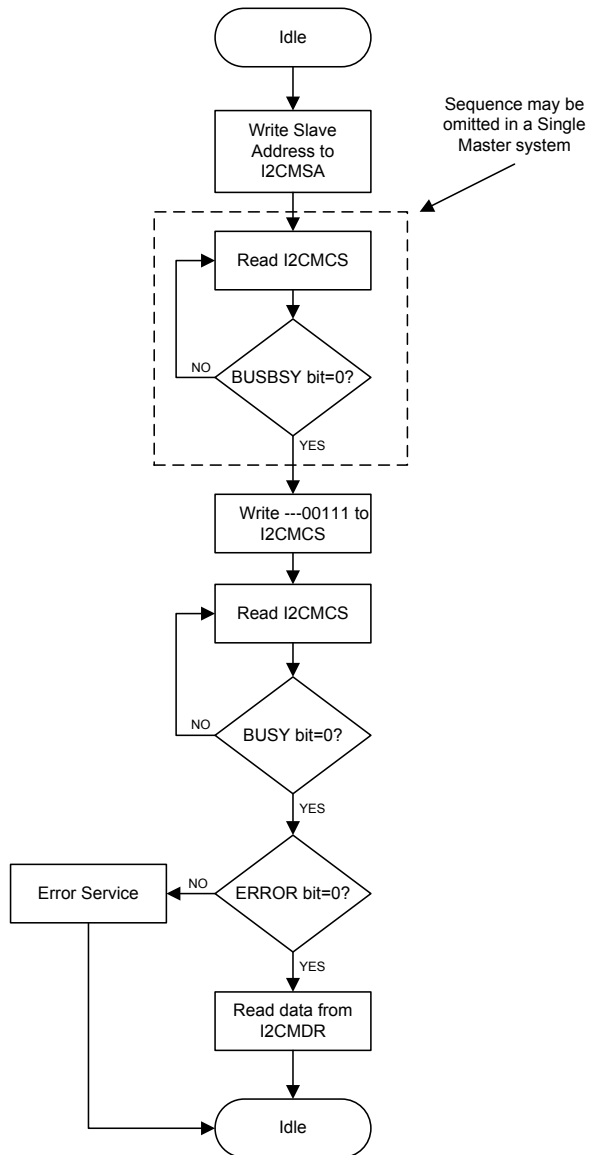

Figure 14-9. Master Burst SEND

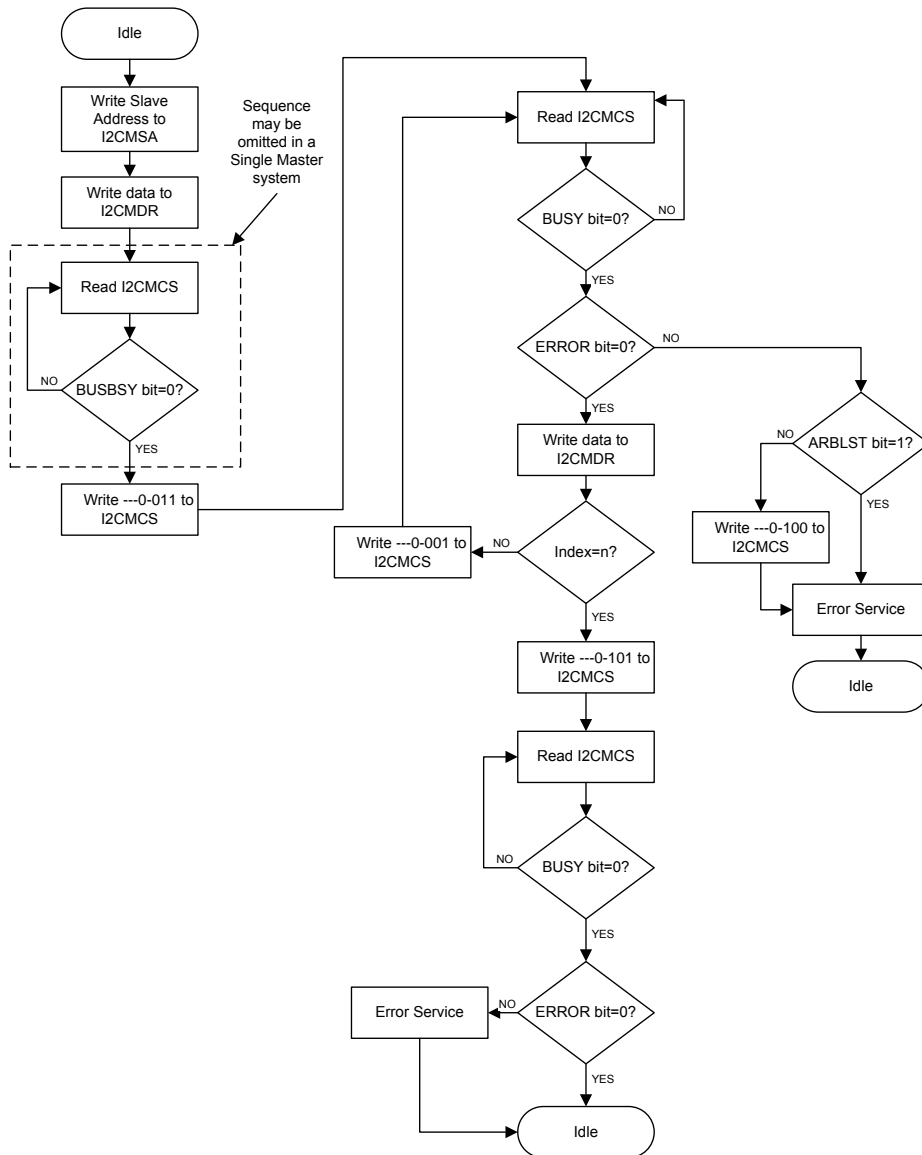

Figure 14-10. Master Burst RECEIVE

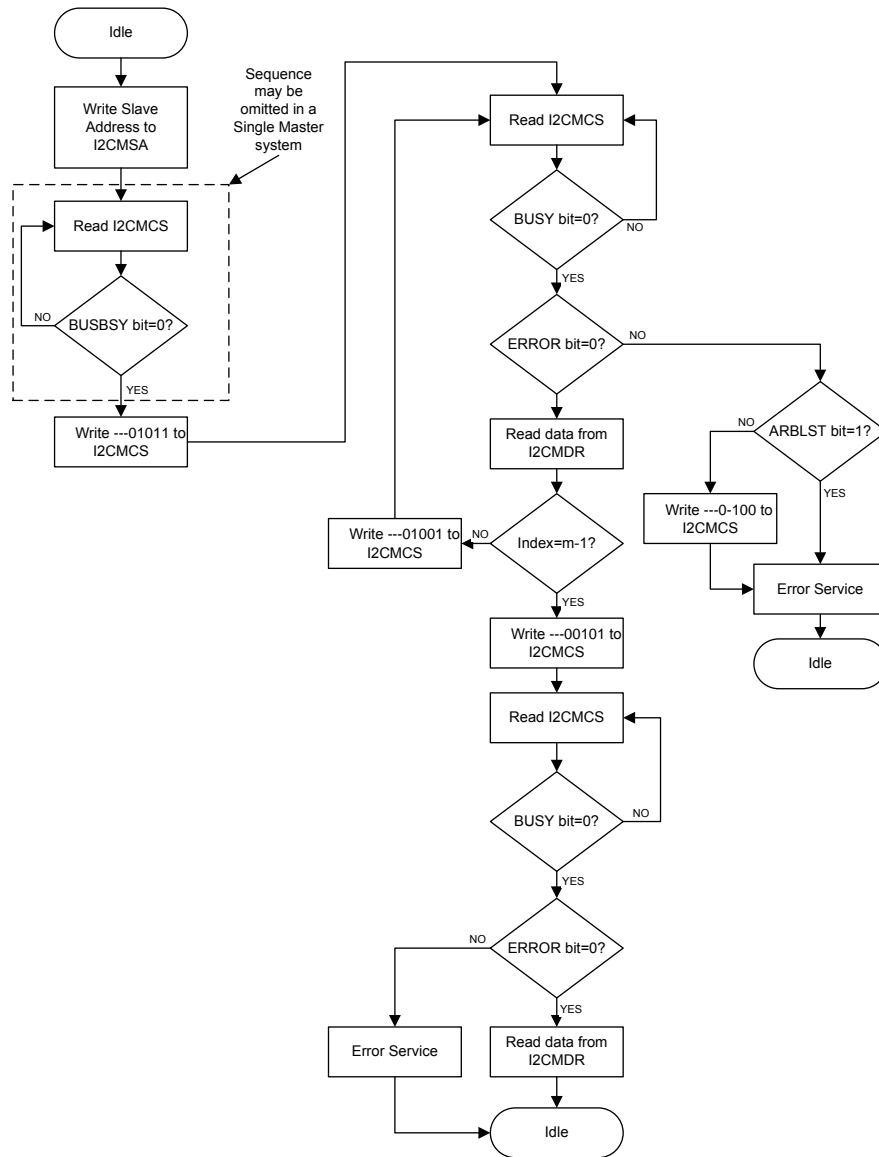

Figure 14-11. Master Burst RECEIVE after Burst SEND

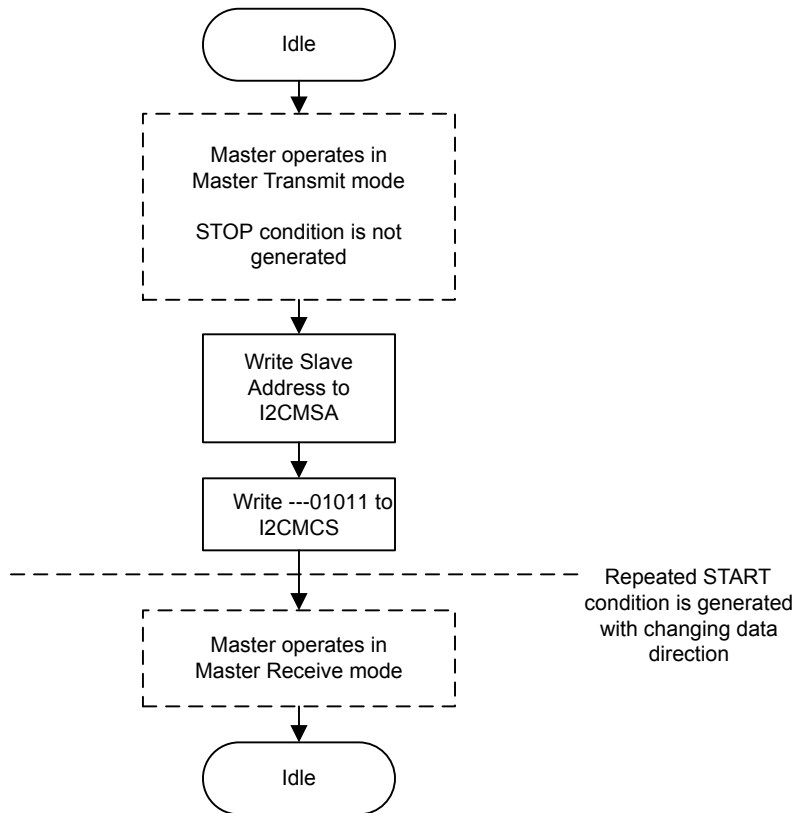
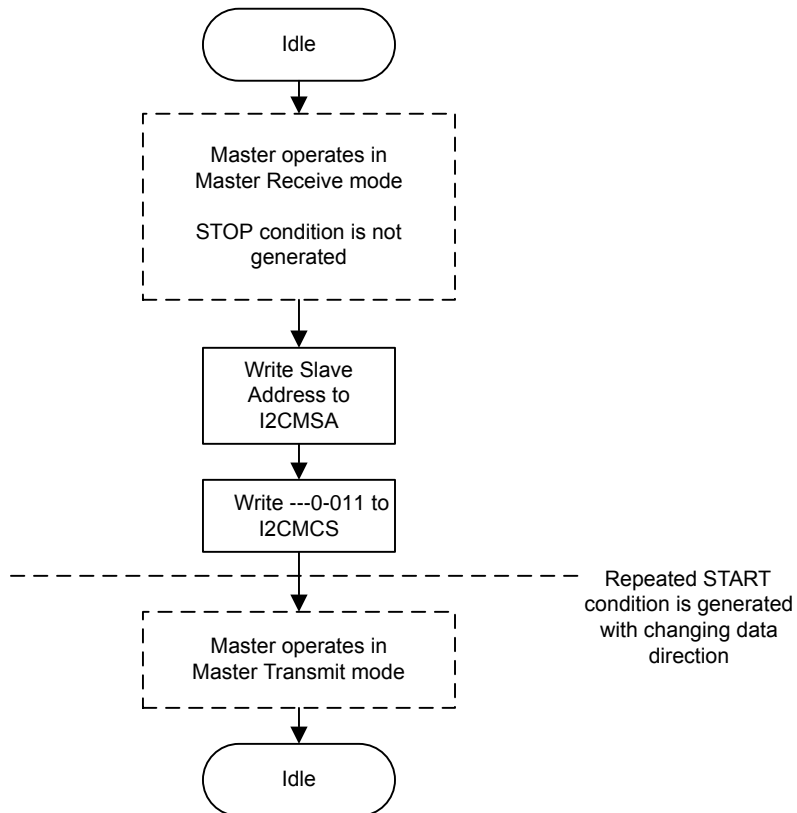

Figure 14-12. Master Burst SEND after Burst RECEIVE



14.2.5.2 I²C Slave Command Sequences

Figure 14-13 on page 342 presents the command sequence available for the I²C slave.

Figure 14-13. Slave Command Sequence

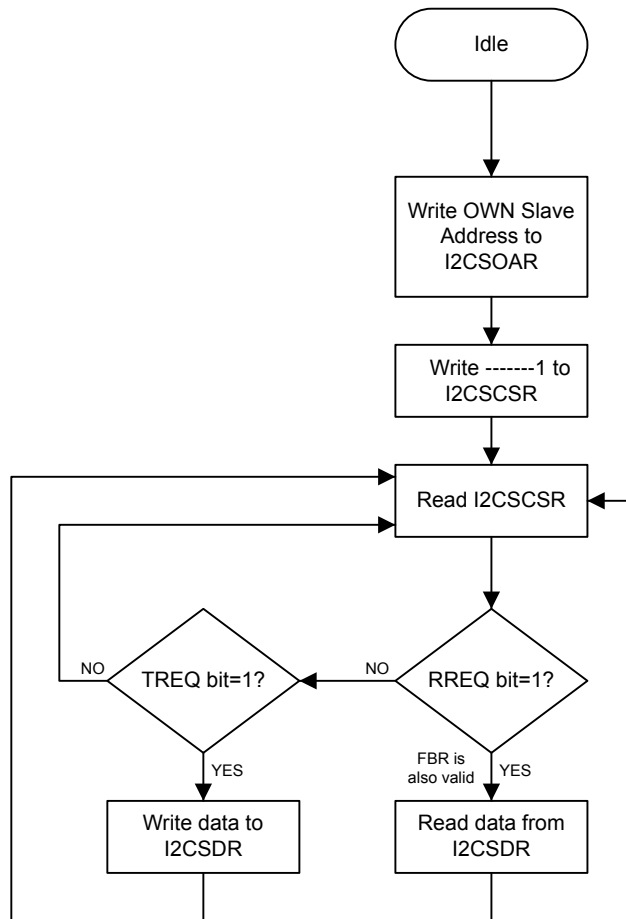

14.3 Initialization and Configuration

The following example shows how to configure the I²C module to send a single byte as a master. This assumes the system clock is 20 MHz.

1. Enable the I²C clock by writing a value of 0x0000.1000 to the **RCGC1** register in the System Control module.
2. Enable the clock to the appropriate GPIO module via the **RCGC2** register in the System Control module.
3. In the GPIO module, enable the appropriate pins for their alternate function using the **GPIOAFSEL** register. Also, be sure to enable the same pins for Open Drain operation.
4. Initialize the I²C Master by writing the **I2CMCR** register with a value of 0x0000.0020.
5. Set the desired SCL clock speed of 100 Kbps by writing the **I2CMTPR** register with the correct value. The value written to the **I2CMTPR** register represents the number of system clock periods in one SCL clock period. The TPR value is determined by the following equation:

```

TPR = (System Clock / (2 * (SCL_LP + SCL_HP) * SCL_CLK)) - 1;
TPR = (20MHz / (2 * (6 + 4) * 100000)) - 1;
TPR = 9

```

Write the **I2CMTPR** register with the value of 0x0000.0009.

6. Specify the slave address of the master and that the next operation will be a Send by writing the **I2CMSA** register with a value of 0x0000.0076. This sets the slave address to 0x3B.
7. Place data (byte) to be sent in the data register by writing the **I2CMDR** register with the desired data.
8. Initiate a single byte send of the data from Master to Slave by writing the **I2CMCS** register with a value of 0x0000.0007 (STOP, START, RUN).
9. Wait until the transmission completes by polling the **I2CMCS** register's **BUSBSY** bit until it has been cleared.

14.4 I²C Register Map

Table 14-2 on page 343 lists the I²C registers. All addresses given are relative to the I²C base addresses for the master and slave:

- I²C Master 0: 0x4002.0000
- I²C Slave 0: 0x4002.0800

Table 14-2. Inter-Integrated Circuit (I²C) Interface Register Map

Offset	Name	Type	Reset	Description	See page
I²C Master					
0x000	I2CMSA	R/W	0x0000.0000	I2C Master Slave Address	345
0x004	I2CMCS	R/W	0x0000.0000	I2C Master Control/Status	346
0x008	I2CMDR	R/W	0x0000.0000	I2C Master Data	350
0x00C	I2CMTPR	R/W	0x0000.0001	I2C Master Timer Period	351
0x010	I2CMIMR	R/W	0x0000.0000	I2C Master Interrupt Mask	352
0x014	I2CMRIS	RO	0x0000.0000	I2C Master Raw Interrupt Status	353
0x018	I2CMMIS	RO	0x0000.0000	I2C Master Masked Interrupt Status	354
0x01C	I2CMICR	WO	0x0000.0000	I2C Master Interrupt Clear	355
0x020	I2CMCR	R/W	0x0000.0000	I2C Master Configuration	356
I²C Slave					
0x000	I2CSOAR	R/W	0x0000.0000	I2C Slave Own Address	358
0x004	I2CSCSR	RO	0x0000.0000	I2C Slave Control/Status	359
0x008	I2CSDR	R/W	0x0000.0000	I2C Slave Data	361
0x00C	I2CSIMR	R/W	0x0000.0000	I2C Slave Interrupt Mask	362

Offset	Name	Type	Reset	Description	See page
0x010	I2CSRIS	RO	0x0000.0000	I2C Slave Raw Interrupt Status	363
0x014	I2CSMIS	RO	0x0000.0000	I2C Slave Masked Interrupt Status	364
0x018	I2CSICR	WO	0x0000.0000	I2C Slave Interrupt Clear	365

14.5 Register Descriptions (I²C Master)

The remainder of this section lists and describes the I²C master registers, in numerical order by address offset. See also “Register Descriptions (I2C Slave)” on page 357.

Register 1: I²C Master Slave Address (I2CMSA), offset 0x000

This register consists of eight bits: seven address bits (A6-A0), and a Receive/Send bit, which determines if the next operation is a Receive (High), or Send (Low).

I2C Master Slave Address (I2CMSA)

I2C Master 0 base: 0x4002.0000

Offset 0x000

Type R/W, reset 0x0000.0000

	31	30	29	28	27	26	25	24	23	22	21	20	19	18	17	16
	reserved															
Type	RO	RO	RO	RO	RO	RO	RO	RO	RO	RO	RO	RO	RO	RO	RO	RO
Reset	0	0	0	0	0	0	0	0	0	0	0	0	0	0	0	0
	15	14	13	12	11	10	9	8	7	6	5	4	3	2	1	0
	reserved								SA							R/S
Type	RO	RO	RO	RO	RO	RO	RO	RO	R/W	R/W	R/W	R/W	R/W	R/W	R/W	R/W
Reset	0	0	0	0	0	0	0	0	0	0	0	0	0	0	0	0

Bit/Field	Name	Type	Reset	Description
31:8	reserved	RO	0x00	Software should not rely on the value of a reserved bit. To provide compatibility with future products, the value of a reserved bit should be preserved across a read-modify-write operation.
7:1	SA	R/W	0	I ² C Slave Address This field specifies bits A6 through A0 of the slave address.
0	R/S	R/W	0	Receive/Send The R/S bit specifies if the next operation is a Receive (High) or Send (Low). Value Description 0 Send. 1 Receive.

Register 2: I²C Master Control/Status (I2CMCS), offset 0x004

This register accesses four control bits when written, and accesses seven status bits when read.

The status register consists of seven bits, which when read determine the state of the I²C bus controller.

The control register consists of four bits: the RUN, START, STOP, and ACK bits. The START bit causes the generation of the START, or REPEATED START condition.

The STOP bit determines if the cycle stops at the end of the data cycle, or continues on to a burst. To generate a single send cycle, the I²C Master Slave Address (I2CMSA) register is written with the desired address, the R/S bit is set to 0, and the Control register is written with ACK=X (0 or 1), STOP=1, START=1, and RUN=1 to perform the operation and stop. When the operation is completed (or aborted due an error), the interrupt pin becomes active and the data may be read from the I2CMDR register. When the I²C module operates in Master receiver mode, the ACK bit must be set normally to logic 1. This causes the I²C bus controller to send an acknowledge automatically after each byte. This bit must be reset when the I²C bus controller requires no further data to be sent from the slave transmitter.

Read-Only Status Register

I2C Master Control/Status (I2CMCS)

I2C Master 0 base: 0x4002.0000

Offset 0x004

Type RO, reset 0x0000.0000

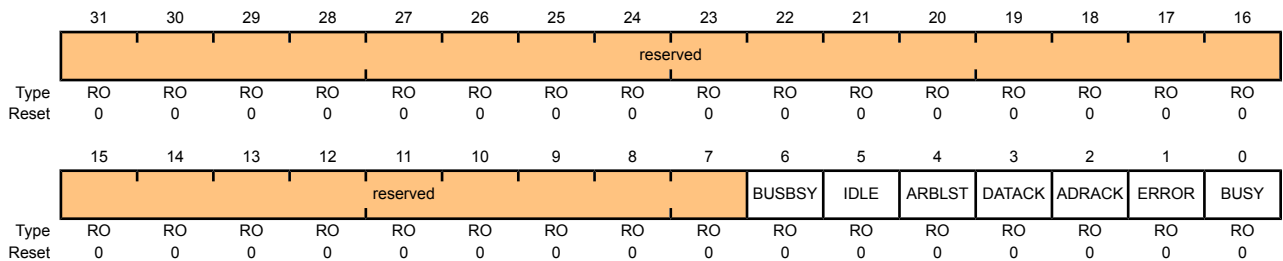

Bit/Field	Name	Type	Reset	Description
31:7	reserved	RO	0x00	Software should not rely on the value of a reserved bit. To provide compatibility with future products, the value of a reserved bit should be preserved across a read-modify-write operation.
6	BUSBSY	RO	0	Bus Busy This bit specifies the state of the I ² C bus. If set, the bus is busy; otherwise, the bus is idle. The bit changes based on the START and STOP conditions.
5	IDLE	RO	0	I ² C Idle This bit specifies the I ² C controller state. If set, the controller is idle; otherwise the controller is not idle.
4	ARBLST	RO	0	Arbitration Lost This bit specifies the result of bus arbitration. If set, the controller lost arbitration; otherwise, the controller won arbitration.

Bit/Field	Name	Type	Reset	Description
3	DATAACK	RO	0	Acknowledge Data This bit specifies the result of the last data operation. If set, the transmitted data was not acknowledged; otherwise, the data was acknowledged.
2	ADRACK	RO	0	Acknowledge Address This bit specifies the result of the last address operation. If set, the transmitted address was not acknowledged; otherwise, the address was acknowledged.
1	ERROR	RO	0	Error This bit specifies the result of the last bus operation. If set, an error occurred on the last operation; otherwise, no error was detected. The error can be from the slave address not being acknowledged, the transmit data not being acknowledged, or because the controller lost arbitration.
0	BUSY	RO	0	I ² C Busy This bit specifies the state of the controller. If set, the controller is busy; otherwise, the controller is idle. When the <code>BUSY</code> bit is set, the other status bits are not valid.

Write-Only Control Register

I2C Master Control/Status (I2CMCS)

I2C Master 0 base: 0x4002.0000
Offset 0x004
Type WO, reset 0x0000.0000



Bit/Field	Name	Type	Reset	Description
31:4	reserved	WO	0x00	Software should not rely on the value of a reserved bit. To provide compatibility with future products, the value of a reserved bit should be preserved across a read-modify-write operation.
3	ACK	WO	0	Data Acknowledge Enable When set, causes received data byte to be acknowledged automatically by the master. See field decoding in Table 14-3 on page 348.
2	STOP	WO	0	Generate STOP When set, causes the generation of the STOP condition. See field decoding in Table 14-3 on page 348.

Bit/Field	Name	Type	Reset	Description
1	START	WO	0	Generate START When set, causes the generation of a START or repeated START condition. See field decoding in Table 14-3 on page 348.
0	RUN	WO	0	I ² C Master Enable When set, allows the master to send or receive data. See field decoding in Table 14-3 on page 348.

Table 14-3. Write Field Decoding for I2CMCS[3:0] Field (Sheet 1 of 3)

Current State	I2CMSA[0]	I2CMCS[3:0]				Description
	R/S	ACK	STOP	START	RUN	
Idle	0	X ^a	0	1	1	START condition followed by SEND (master goes to the Master Transmit state).
	0	X	1	1	1	START condition followed by a SEND and STOP condition (master remains in Idle state).
	1	0	0	1	1	START condition followed by RECEIVE operation with negative ACK (master goes to the Master Receive state).
	1	0	1	1	1	START condition followed by RECEIVE and STOP condition (master remains in Idle state).
	1	1	0	1	1	START condition followed by RECEIVE (master goes to the Master Receive state).
	1	1	1	1	1	Illegal.
	All other combinations not listed are non-operations.					
Master Transmit	X	X	0	0	1	SEND operation (master remains in Master Transmit state).
	X	X	1	0	0	STOP condition (master goes to Idle state).
	X	X	1	0	1	SEND followed by STOP condition (master goes to Idle state).
	0	X	0	1	1	Repeated START condition followed by a SEND (master remains in Master Transmit state).
	0	X	1	1	1	Repeated START condition followed by SEND and STOP condition (master goes to Idle state).
	1	0	0	1	1	Repeated START condition followed by a RECEIVE operation with a negative ACK (master goes to Master Receive state).
	1	0	1	1	1	Repeated START condition followed by a SEND and STOP condition (master goes to Idle state).
	1	1	0	1	1	Repeated START condition followed by RECEIVE (master goes to Master Receive state).
	1	1	1	1	1	Illegal.
	All other combinations not listed are non-operations.					

Current State	I2CMSA[0]	I2CMCS[3:0]				Description
	R/S	ACK	STOP	START	RUN	
Master Receive	X	0	0	0	1	RECEIVE operation with negative ACK (master remains in Master Receive state).
	X	X	1	0	0	STOP condition (master goes to Idle state). ^b
	X	0	1	0	1	RECEIVE followed by STOP condition (master goes to Idle state).
	X	1	0	0	1	RECEIVE operation (master remains in Master Receive state).
	X	1	1	0	1	Illegal.
	1	0	0	1	1	Repeated START condition followed by RECEIVE operation with a negative ACK (master remains in Master Receive state).
	1	0	1	1	1	Repeated START condition followed by RECEIVE and STOP condition (master goes to Idle state).
	1	1	0	1	1	Repeated START condition followed by RECEIVE (master remains in Master Receive state).
	0	X	0	1	1	Repeated START condition followed by SEND (master goes to Master Transmit state).
	0	X	1	1	1	Repeated START condition followed by SEND and STOP condition (master goes to Idle state).
All other combinations not listed are non-operations.						NOP.

a. An X in a table cell indicates the bit can be 0 or 1.

b. In Master Receive mode, a STOP condition should be generated only after a Data Negative Acknowledge executed by the master or an Address Negative Acknowledge executed by the slave.

Register 3: I²C Master Data (I2CMDR), offset 0x008

This register contains the data to be transmitted when in the Master Transmit state, and the data received when in the Master Receive state.

I2C Master Data (I2CMDR)

I2C Master 0 base: 0x4002.0000

Offset 0x008

Type R/W, reset 0x0000.0000

	31	30	29	28	27	26	25	24	23	22	21	20	19	18	17	16
	reserved															
Type	RO	RO	RO	RO	RO	RO	RO	RO	RO	RO	RO	RO	RO	RO	RO	RO
Reset	0	0	0	0	0	0	0	0	0	0	0	0	0	0	0	0
	15	14	13	12	11	10	9	8	7	6	5	4	3	2	1	0
	reserved								DATA							
Type	RO	RO	RO	RO	RO	RO	RO	RO	R/W	R/W	R/W	R/W	R/W	R/W	R/W	R/W
Reset	0	0	0	0	0	0	0	0	0	0	0	0	0	0	0	0

Bit/Field	Name	Type	Reset	Description
31:8	reserved	RO	0x00	Software should not rely on the value of a reserved bit. To provide compatibility with future products, the value of a reserved bit should be preserved across a read-modify-write operation.
7:0	DATA	R/W	0x00	Data Transferred Data transferred during transaction.

Register 4: I²C Master Timer Period (I2CMTPR), offset 0x00C

This register specifies the period of the SCL clock.

I2C Master Timer Period (I2CMTPR)

I2C Master 0 base: 0x4002.0000

Offset 0x00C

Type R/W, reset 0x0000.0001

	31	30	29	28	27	26	25	24	23	22	21	20	19	18	17	16
	reserved															
Type	RO	RO	RO	RO	RO	RO	RO	RO	RO	RO	RO	RO	RO	RO	RO	RO
Reset	0	0	0	0	0	0	0	0	0	0	0	0	0	0	0	0
	15	14	13	12	11	10	9	8	7	6	5	4	3	2	1	0
	reserved								TPR							
Type	RO	RO	RO	RO	RO	RO	RO	RO	R/W	R/W	R/W	R/W	R/W	R/W	R/W	R/W
Reset	0	0	0	0	0	0	0	0	0	0	0	0	0	0	0	1

Bit/Field	Name	Type	Reset	Description
31:8	reserved	RO	0x00	Software should not rely on the value of a reserved bit. To provide compatibility with future products, the value of a reserved bit should be preserved across a read-modify-write operation.
7:0	TPR	R/W	0x1	SCL Clock Period

This field specifies the period of the SCL clock.

$$SCL_PRD = 2 * (1 + TPR) * (SCL_LP + SCL_HP) * CLK_PRD$$

where:

SCL_PRD is the SCL line period (I²C clock).

TPR is the Timer Period register value (range of 1 to 255).

SCL_LP is the SCL Low period (fixed at 6).

SCL_HP is the SCL High period (fixed at 4).

Register 5: I²C Master Interrupt Mask (I2CMIMR), offset 0x010

This register controls whether a raw interrupt is promoted to a controller interrupt.

I2C Master Interrupt Mask (I2CMIMR)

I2C Master 0 base: 0x4002.0000

Offset 0x010

Type R/W, reset 0x0000.0000

	31	30	29	28	27	26	25	24	23	22	21	20	19	18	17	16
	reserved															
Type	RO	RO	RO	RO	RO	RO	RO	RO	RO	RO	RO	RO	RO	RO	RO	RO
Reset	0	0	0	0	0	0	0	0	0	0	0	0	0	0	0	0
	15	14	13	12	11	10	9	8	7	6	5	4	3	2	1	0
	reserved															
Type	RO	RO	RO	RO	RO	RO	RO	RO	RO	RO	RO	RO	RO	RO	RO	R/W
Reset	0	0	0	0	0	0	0	0	0	0	0	0	0	0	0	0

Bit/Field	Name	Type	Reset	Description
31:1	reserved	RO	0x00	Software should not rely on the value of a reserved bit. To provide compatibility with future products, the value of a reserved bit should be preserved across a read-modify-write operation.
0	IM	R/W	0	Interrupt Mask This bit controls whether a raw interrupt is promoted to a controller interrupt. If set, the interrupt is not masked and the interrupt is promoted; otherwise, the interrupt is masked.

Register 6: I²C Master Raw Interrupt Status (I2CMRIS), offset 0x014

This register specifies whether an interrupt is pending.

I2C Master Raw Interrupt Status (I2CMRIS)

I2C Master 0 base: 0x4002.0000

Offset 0x014

Type RO, reset 0x0000.0000

	31	30	29	28	27	26	25	24	23	22	21	20	19	18	17	16	
	reserved																
Type	RO	RO	RO	RO	RO	RO	RO	RO	RO	RO	RO	RO	RO	RO	RO	RO	
Reset	0	0	0	0	0	0	0	0	0	0	0	0	0	0	0	0	
	15	14	13	12	11	10	9	8	7	6	5	4	3	2	1	0	
	reserved															RIS	
Type	RO	RO	RO	RO	RO	RO	RO	RO	RO	RO	RO	RO	RO	RO	RO	RO	RO
Reset	0	0	0	0	0	0	0	0	0	0	0	0	0	0	0	0	0

Bit/Field	Name	Type	Reset	Description
31:1	reserved	RO	0x00	Software should not rely on the value of a reserved bit. To provide compatibility with future products, the value of a reserved bit should be preserved across a read-modify-write operation.
0	RIS	RO	0	Raw Interrupt Status This bit specifies the raw interrupt state (prior to masking) of the I ² C master block. If set, an interrupt is pending; otherwise, an interrupt is not pending.

Register 7: I²C Master Masked Interrupt Status (I2CMMIS), offset 0x018

This register specifies whether an interrupt was signaled.

I2C Master Masked Interrupt Status (I2CMMIS)

I2C Master 0 base: 0x4002.0000

Offset 0x018

Type RO, reset 0x0000.0000

	31	30	29	28	27	26	25	24	23	22	21	20	19	18	17	16
	reserved															
Type	RO	RO	RO	RO	RO	RO	RO	RO	RO	RO	RO	RO	RO	RO	RO	RO
Reset	0	0	0	0	0	0	0	0	0	0	0	0	0	0	0	0
	15	14	13	12	11	10	9	8	7	6	5	4	3	2	1	0
	reserved															MIS
Type	RO	RO	RO	RO	RO	RO	RO	RO	RO	RO	RO	RO	RO	RO	RO	RO
Reset	0	0	0	0	0	0	0	0	0	0	0	0	0	0	0	0

Bit/Field	Name	Type	Reset	Description
31:1	reserved	RO	0x00	Software should not rely on the value of a reserved bit. To provide compatibility with future products, the value of a reserved bit should be preserved across a read-modify-write operation.
0	MIS	RO	0	Masked Interrupt Status This bit specifies the raw interrupt state (after masking) of the I ² C master block. If set, an interrupt was signaled; otherwise, an interrupt has not been generated since the bit was last cleared.

Register 8: I²C Master Interrupt Clear (I2CMICR), offset 0x01C

This register clears the raw interrupt.

I2C Master Interrupt Clear (I2CMICR)

I2C Master 0 base: 0x4002.0000

Offset 0x01C

Type WO, reset 0x0000.0000

	31	30	29	28	27	26	25	24	23	22	21	20	19	18	17	16
	reserved															
Type	RO	RO	RO	RO	RO	RO	RO	RO	RO	RO	RO	RO	RO	RO	RO	RO
Reset	0	0	0	0	0	0	0	0	0	0	0	0	0	0	0	0
	15	14	13	12	11	10	9	8	7	6	5	4	3	2	1	0
	reserved															IC
Type	RO	RO	RO	RO	RO	RO	RO	RO	RO	RO	RO	RO	RO	RO	RO	WO
Reset	0	0	0	0	0	0	0	0	0	0	0	0	0	0	0	0

Bit/Field	Name	Type	Reset	Description
31:1	reserved	RO	0x00	Software should not rely on the value of a reserved bit. To provide compatibility with future products, the value of a reserved bit should be preserved across a read-modify-write operation.
0	IC	WO	0	Interrupt Clear This bit controls the clearing of the raw interrupt. A write of 1 clears the interrupt; otherwise, a write of 0 has no affect on the interrupt state. A read of this register returns no meaningful data.

Register 9: I²C Master Configuration (I2CMCR), offset 0x020

This register configures the mode (Master or Slave) and sets the interface for test mode loopback.

I2C Master Configuration (I2CMCR)

I2C Master 0 base: 0x4002.0000

Offset 0x020

Type R/W, reset 0x0000.0000

	31	30	29	28	27	26	25	24	23	22	21	20	19	18	17	16
	reserved															
Type	RO	RO	RO	RO	RO	RO	RO	RO	RO	RO	RO	RO	RO	RO	RO	RO
Reset	0	0	0	0	0	0	0	0	0	0	0	0	0	0	0	0
	15	14	13	12	11	10	9	8	7	6	5	4	3	2	1	0
	reserved										SFE	MFE	reserved			LPBK
Type	RO	RO	RO	RO	RO	RO	RO	RO	RO	RO	R/W	R/W	RO	RO	RO	R/W
Reset	0	0	0	0	0	0	0	0	0	0	0	0	0	0	0	0

Bit/Field	Name	Type	Reset	Description
31:6	reserved	RO	0x00	Software should not rely on the value of a reserved bit. To provide compatibility with future products, the value of a reserved bit should be preserved across a read-modify-write operation.
5	SFE	R/W	0	I ² C Slave Function Enable This bit specifies whether the interface may operate in Slave mode. If set, Slave mode is enabled; otherwise, Slave mode is disabled.
4	MFE	R/W	0	I ² C Master Function Enable This bit specifies whether the interface may operate in Master mode. If set, Master mode is enabled; otherwise, Master mode is disabled and the interface clock is disabled.
3:1	reserved	RO	0x00	Software should not rely on the value of a reserved bit. To provide compatibility with future products, the value of a reserved bit should be preserved across a read-modify-write operation.
0	LPBK	R/W	0	I ² C Loopback This bit specifies whether the interface is operating normally or in Loopback mode. If set, the device is put in a test mode loopback configuration; otherwise, the device operates normally.

14.6 Register Descriptions (I2C Slave)

The remainder of this section lists and describes the I²C slave registers, in numerical order by address offset. See also “Register Descriptions (I²C Master)” on page 344.

Register 10: I²C Slave Own Address (I2CSOAR), offset 0x000

This register consists of seven address bits that identify the Stellaris[®] I²C device on the I²C bus.

I2C Slave Own Address (I2CSOAR)

I2C Slave 0 base: 0x4002.0800

Offset 0x000

Type R/W, reset 0x0000.0000

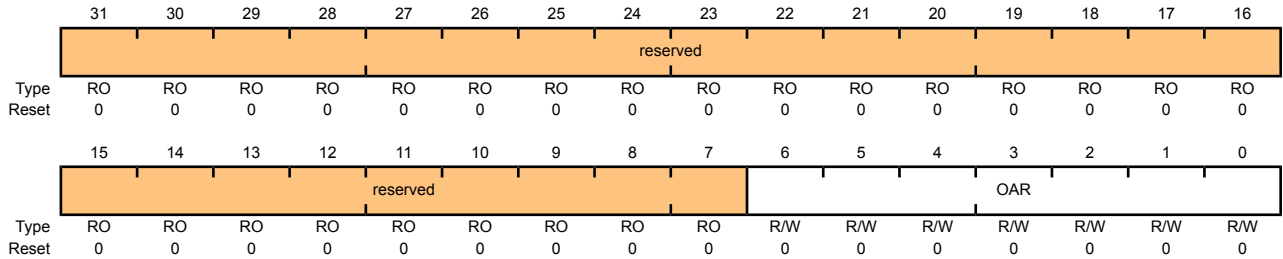

Bit/Field	Name	Type	Reset	Description
31:7	reserved	RO	0x00	Software should not rely on the value of a reserved bit. To provide compatibility with future products, the value of a reserved bit should be preserved across a read-modify-write operation.
6:0	OAR	R/W	0x00	I ² C Slave Own Address This field specifies bits A6 through A0 of the slave address.

Register 11: I²C Slave Control/Status (I2CCSR), offset 0x004

This register accesses one control bit when written, and three status bits when read.

The read-only Status register consists of three bits: the `FBR`, `RREQ`, and `TREQ` bits. The `First Byte Received (FBR)` bit is set only after the Stellaris[®] device detects its own slave address and receives the first data byte from the I²C master. The `Receive Request (RREQ)` bit indicates that the Stellaris[®] I²C device has received a data byte from an I²C master. Read one data byte from the **I²C Slave Data (I2CSDR)** register to clear the `RREQ` bit. The `Transmit Request (TREQ)` bit indicates that the Stellaris[®] I²C device is addressed as a Slave Transmitter. Write one data byte into the **I²C Slave Data (I2CSDR)** register to clear the `TREQ` bit.

The write-only Control register consists of one bit: the `DA` bit. The `DA` bit enables and disables the Stellaris[®] I²C slave operation.

Read-Only Status Register

I2C Slave Control/Status (I2CCSR)

I2C Slave 0 base: 0x4002.0800

Offset 0x004

Type RO, reset 0x0000.0000

	31	30	29	28	27	26	25	24	23	22	21	20	19	18	17	16
	reserved															
Type	RO	RO	RO	RO	RO	RO	RO	RO	RO	RO	RO	RO	RO	RO	RO	RO
Reset	0	0	0	0	0	0	0	0	0	0	0	0	0	0	0	0
	15	14	13	12	11	10	9	8	7	6	5	4	3	2	1	0
	reserved													FBR	TREQ	RREQ
Type	RO	RO	RO	RO	RO	RO	RO	RO	RO	RO	RO	RO	RO	RO	RO	RO
Reset	0	0	0	0	0	0	0	0	0	0	0	0	0	0	0	0

Bit/Field	Name	Type	Reset	Description
31:3	reserved	RO	0x00	Software should not rely on the value of a reserved bit. To provide compatibility with future products, the value of a reserved bit should be preserved across a read-modify-write operation.
2	FBR	RO	0	<p>First Byte Received</p> <p>Indicates that the first byte following the slave's own address is received. This bit is only valid when the <code>RREQ</code> bit is set, and is automatically cleared when data has been read from the I2CSDR register.</p> <p>Note: This bit is not used for slave transmit operations.</p>
1	TREQ	RO	0	<p>Transmit Request</p> <p>This bit specifies the state of the I²C slave with regards to outstanding transmit requests. If set, the I²C unit has been addressed as a slave transmitter and uses clock stretching to delay the master until data has been written to the I2CSDR register. Otherwise, there is no outstanding transmit request.</p>

Bit/Field	Name	Type	Reset	Description
0	RREQ	RO	0	Receive Request

This bit specifies the status of the I²C slave with regards to outstanding receive requests. If set, the I²C unit has outstanding receive data from the I²C master and uses clock stretching to delay the master until the data has been read from the **I2CSDR** register. Otherwise, no receive data is outstanding.

Write-Only Control Register

I2C Slave Control/Status (I2CSCSR)

I2C Slave 0 base: 0x4002.0800
 Offset 0x004
 Type WO, reset 0x0000.0000

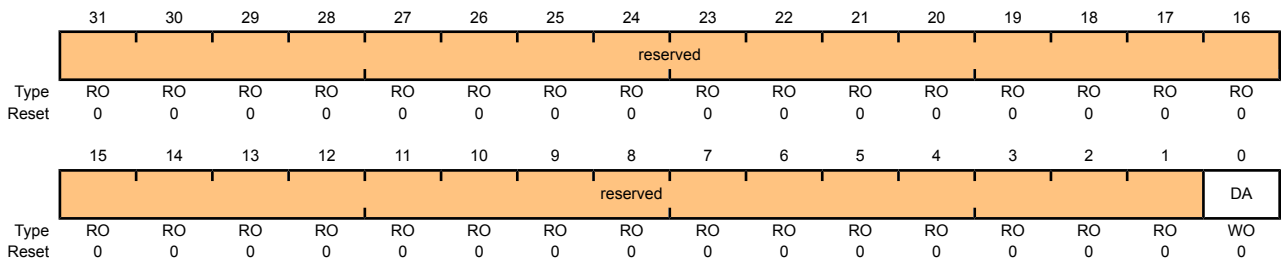

Bit/Field	Name	Type	Reset	Description
31:1	reserved	RO	0x00	Software should not rely on the value of a reserved bit. To provide compatibility with future products, the value of a reserved bit should be preserved across a read-modify-write operation.
0	DA	WO	0	Device Active

Value	Description
0	Disables the I ² C slave operation.
1	Enables the I ² C slave operation.

Register 12: I²C Slave Data (I2CSDR), offset 0x008

This register contains the data to be transmitted when in the Slave Transmit state, and the data received when in the Slave Receive state.

I2C Slave Data (I2CSDR)

I2C Slave 0 base: 0x4002.0800

Offset 0x008

Type R/W, reset 0x0000.0000

	31	30	29	28	27	26	25	24	23	22	21	20	19	18	17	16
	reserved															
Type	RO	RO	RO	RO	RO	RO	RO	RO	RO	RO	RO	RO	RO	RO	RO	RO
Reset	0	0	0	0	0	0	0	0	0	0	0	0	0	0	0	0
	15	14	13	12	11	10	9	8	7	6	5	4	3	2	1	0
	reserved								DATA							
Type	RO	RO	RO	RO	RO	RO	RO	RO	R/W	R/W	R/W	R/W	R/W	R/W	R/W	R/W
Reset	0	0	0	0	0	0	0	0	0	0	0	0	0	0	0	0

Bit/Field	Name	Type	Reset	Description
31:8	reserved	RO	0x00	Software should not rely on the value of a reserved bit. To provide compatibility with future products, the value of a reserved bit should be preserved across a read-modify-write operation.
7:0	DATA	R/W	0x0	Data for Transfer This field contains the data for transfer during a slave receive or transmit operation.

Register 13: I²C Slave Interrupt Mask (I2CSIMR), offset 0x00C

This register controls whether a raw interrupt is promoted to a controller interrupt.

I2C Slave Interrupt Mask (I2CSIMR)

I2C Slave 0 base: 0x4002.0800

Offset 0x00C

Type R/W, reset 0x0000.0000

	31	30	29	28	27	26	25	24	23	22	21	20	19	18	17	16
	reserved															
Type	RO	RO	RO	RO	RO	RO	RO	RO	RO	RO	RO	RO	RO	RO	RO	RO
Reset	0	0	0	0	0	0	0	0	0	0	0	0	0	0	0	0
	15	14	13	12	11	10	9	8	7	6	5	4	3	2	1	0
	reserved															
Type	RO	RO	RO	RO	RO	RO	RO	RO	RO	RO	RO	RO	RO	RO	RO	R/W
Reset	0	0	0	0	0	0	0	0	0	0	0	0	0	0	0	0

Bit/Field	Name	Type	Reset	Description
31:1	reserved	RO	0x00	Software should not rely on the value of a reserved bit. To provide compatibility with future products, the value of a reserved bit should be preserved across a read-modify-write operation.
0	DATAIM	R/W	0	Data Interrupt Mask This bit controls whether the raw interrupt for data received and data requested is promoted to a controller interrupt. If set, the interrupt is not masked and the interrupt is promoted; otherwise, the interrupt is masked.

Register 14: I²C Slave Raw Interrupt Status (I2CSRIS), offset 0x010

This register specifies whether an interrupt is pending.

I2C Slave Raw Interrupt Status (I2CSRIS)

I2C Slave 0 base: 0x4002.0800

Offset 0x010

Type RO, reset 0x0000.0000

	31	30	29	28	27	26	25	24	23	22	21	20	19	18	17	16
	reserved															
Type	RO	RO	RO	RO	RO	RO	RO	RO	RO	RO	RO	RO	RO	RO	RO	RO
Reset	0	0	0	0	0	0	0	0	0	0	0	0	0	0	0	0
	15	14	13	12	11	10	9	8	7	6	5	4	3	2	1	0
	reserved															
																DATARIS
Type	RO	RO	RO	RO	RO	RO	RO	RO	RO	RO	RO	RO	RO	RO	RO	RO
Reset	0	0	0	0	0	0	0	0	0	0	0	0	0	0	0	0

Bit/Field	Name	Type	Reset	Description
31:1	reserved	RO	0x00	Software should not rely on the value of a reserved bit. To provide compatibility with future products, the value of a reserved bit should be preserved across a read-modify-write operation.
0	DATARIS	RO	0	Data Raw Interrupt Status This bit specifies the raw interrupt state for data received and data requested (prior to masking) of the I ² C slave block. If set, an interrupt is pending; otherwise, an interrupt is not pending.

Register 15: I²C Slave Masked Interrupt Status (I2CSMIS), offset 0x014

This register specifies whether an interrupt was signaled.

I2C Slave Masked Interrupt Status (I2CSMIS)

I2C Slave 0 base: 0x4002.0800

Offset 0x014

Type RO, reset 0x0000.0000

	31	30	29	28	27	26	25	24	23	22	21	20	19	18	17	16
	reserved															
Type	RO	RO	RO	RO	RO	RO	RO	RO	RO	RO	RO	RO	RO	RO	RO	RO
Reset	0	0	0	0	0	0	0	0	0	0	0	0	0	0	0	0
	15	14	13	12	11	10	9	8	7	6	5	4	3	2	1	0
	reserved															DATAMIS
Type	RO	RO	RO	RO	RO	RO	RO	RO	RO	RO	RO	RO	RO	RO	RO	RO
Reset	0	0	0	0	0	0	0	0	0	0	0	0	0	0	0	0

Bit/Field	Name	Type	Reset	Description
31:1	reserved	RO	0x00	Software should not rely on the value of a reserved bit. To provide compatibility with future products, the value of a reserved bit should be preserved across a read-modify-write operation.
0	DATAMIS	RO	0	Data Masked Interrupt Status This bit specifies the interrupt state for data received and data requested (after masking) of the I ² C slave block. If set, an interrupt was signaled; otherwise, an interrupt has not been generated since the bit was last cleared.

Register 16: I²C Slave Interrupt Clear (I2CSICR), offset 0x018

This register clears the raw interrupt. A read of this register returns no meaningful data.

I2C Slave Interrupt Clear (I2CSICR)

I2C Slave 0 base: 0x4002.0800

Offset 0x018

Type WO, reset 0x0000.0000

	31	30	29	28	27	26	25	24	23	22	21	20	19	18	17	16	
	reserved																
Type	RO	RO	RO	RO	RO	RO	RO	RO	RO	RO	RO	RO	RO	RO	RO	RO	
Reset	0	0	0	0	0	0	0	0	0	0	0	0	0	0	0	0	
	15	14	13	12	11	10	9	8	7	6	5	4	3	2	1	0	
	reserved															DATAIC	
Type	RO	RO	RO	RO	RO	RO	RO	RO	RO	RO	RO	RO	RO	RO	RO	RO	WO
Reset	0	0	0	0	0	0	0	0	0	0	0	0	0	0	0	0	0

Bit/Field	Name	Type	Reset	Description
31:1	reserved	RO	0x00	Software should not rely on the value of a reserved bit. To provide compatibility with future products, the value of a reserved bit should be preserved across a read-modify-write operation.
0	DATAIC	WO	0	Data Interrupt Clear This bit controls the clearing of the raw interrupt for data received and data requested. When set, it clears the <code>DATARIS</code> interrupt bit; otherwise, it has no effect on the <code>DATARIS</code> bit value.

15 Pin Diagram

The LM3S828 microcontroller pin diagram is shown below.

Figure 15-1. 48-Pin QFP Package Pin Diagram

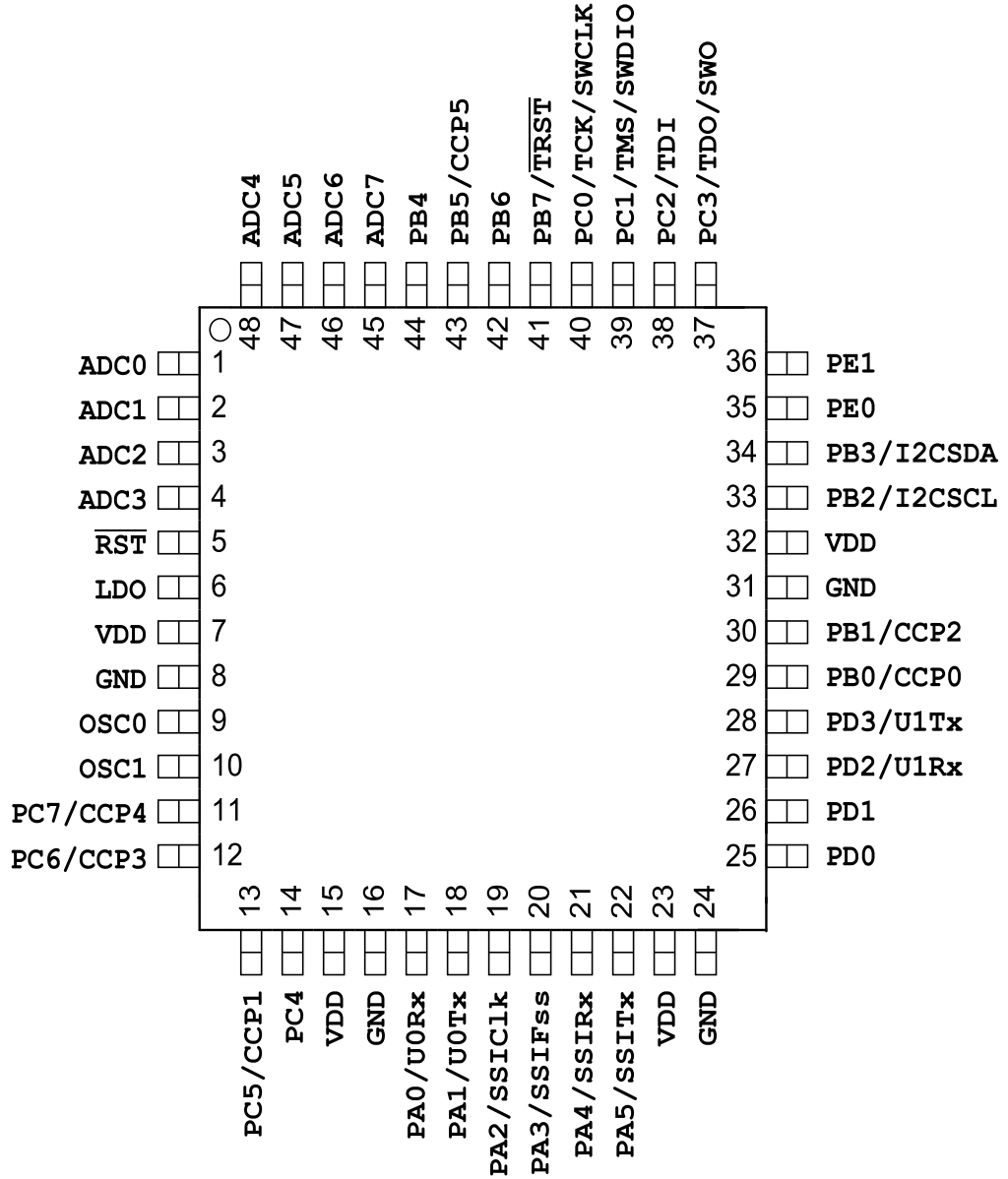

LM3S828

16 Signal Tables

The following tables list the signals available for each pin. Functionality is enabled by software with the **GPIOAFSEL** register.

Important: All multiplexed pins are GPIOs by default, with the exception of the five JTAG pins ($PB7$ and $PC[3:0]$) which default to the JTAG functionality.

Table 16-1 on page 367 shows the pin-to-signal-name mapping, including functional characteristics of the signals. Table 16-2 on page 369 lists the signals in alphabetical order by signal name.

Table 16-3 on page 371 groups the signals by functionality, except for GPIOs. Table 16-4 on page 372 lists the GPIO pins and their alternate functionality.

Table 16-1. Signals by Pin Number

Pin Number	Pin Name	Pin Type	Buffer Type	Description
1	ADC0	I	Analog	Analog-to-digital converter input 0.
2	ADC1	I	Analog	Analog-to-digital converter input 1.
3	ADC2	I	Analog	Analog-to-digital converter input 2.
4	ADC3	I	Analog	Analog-to-digital converter input 3.
5	\overline{RST}	I	TTL	System reset input.
6	LDO	-	Power	Low drop-out regulator output voltage. This pin requires an external capacitor between the pin and GND of 1 μ F or greater.
7	VDD	-	Power	Positive supply for I/O and some logic.
8	GND	-	Power	Ground reference for logic and I/O pins.
9	OSC0	I	Analog	Main oscillator crystal input or an external clock reference input.
10	OSC1	O	Analog	Main oscillator crystal output.
11	PC7	I/O	TTL	GPIO port C bit 7
	CCP4	I/O	TTL	Capture/Compare/PWM 4
12	PC6	I/O	TTL	GPIO port C bit 6
	CCP3	I/O	TTL	Capture/Compare/PWM 3
13	PC5	I/O	TTL	GPIO port C bit 5
	CCP1	I/O	TTL	Capture/Compare/PWM 1
14	PC4	I/O	TTL	GPIO port C bit 4
15	VDD	-	Power	Positive supply for I/O and some logic.
16	GND	-	Power	Ground reference for logic and I/O pins.
17	PA0	I/O	TTL	GPIO port A bit 0
	U0Rx	I	TTL	UART module 0 receive
18	PA1	I/O	TTL	GPIO port A bit 1
	U0Tx	O	TTL	UART module 0 transmit
19	PA2	I/O	TTL	GPIO port A bit 2
	SSIClk	I/O	TTL	SSI clock
20	PA3	I/O	TTL	GPIO port A bit 3
	SSIFss	I/O	TTL	SSI frame

Pin Number	Pin Name	Pin Type	Buffer Type	Description
21	PA4	I/O	TTL	GPIO port A bit 4
	SSIRx	I	TTL	SSI module 0 receive
22	PA5	I/O	TTL	GPIO port A bit 5
	SSITx	O	TTL	SSI module 0 transmit
23	VDD	-	Power	Positive supply for I/O and some logic.
24	GND	-	Power	Ground reference for logic and I/O pins.
25	PD0	I/O	TTL	GPIO port D bit 0
26	PD1	I/O	TTL	GPIO port D bit 1
27	PD2	I/O	TTL	GPIO port D bit 2
	U1Rx	I	TTL	UART module 1 receive. When in IrDA mode, this signal has IrDA modulation.
28	PD3	I/O	TTL	GPIO port D bit 3
	U1Tx	O	TTL	UART module 1 transmit. When in IrDA mode, this signal has IrDA modulation.
29	PB0	I/O	TTL	GPIO port B bit 0
	CCP0	I/O	TTL	Capture/Compare/PWM 0
30	PB1	I/O	TTL	GPIO port B bit 1
	CCP2	I/O	TTL	Capture/Compare/PWM 2
31	GND	-	Power	Ground reference for logic and I/O pins.
32	VDD	-	Power	Positive supply for I/O and some logic.
33	PB2	I/O	TTL	GPIO port B bit 2
	I2CSCL	I/O	OD	I2C module 0 clock
34	PB3	I/O	TTL	GPIO port B bit 3
	I2CSDA	I/O	OD	I2C module 0 data
35	PE0	I/O	TTL	GPIO port E bit 0
36	PE1	I/O	TTL	GPIO port E bit 1
37	PC3	I/O	TTL	GPIO port C bit 3
	TDO	O	TTL	JTAG TDO and SWO
	SWO	O	TTL	JTAG TDO and SWO
38	PC2	I/O	TTL	GPIO port C bit 2
	TDI	I	TTL	JTAG TDI
39	PC1	I/O	TTL	GPIO port C bit 1
	TMS	I/O	TTL	JTAG TMS and SWDIO
	SWDIO	I/O	TTL	JTAG TMS and SWDIO
40	PC0	I/O	TTL	GPIO port C bit 0
	TCK	I	TTL	JTAG/SWD CLK
	SWCLK	I	TTL	JTAG/SWD CLK
41	PB7	I/O	TTL	GPIO port B bit 7
	TRST	I	TTL	JTAG TRSTn
42	PB6	I/O	TTL	GPIO port B bit 6
43	PB5	I/O	TTL	GPIO port B bit 5
	CCP5	I/O	TTL	Capture/Compare/PWM 5
44	PB4	I/O	TTL	GPIO port B bit 4

Pin Number	Pin Name	Pin Type	Buffer Type	Description
45	ADC7	I	Analog	ADC 7 input
46	ADC6	I	Analog	ADC 6 input
47	ADC5	I	Analog	ADC 5 input
48	ADC4	I	Analog	ADC 4 input

Table 16-2. Signals by Signal Name

Pin Name	Pin Number	Pin Type	Buffer Type	Description
ADC0	1	I	Analog	Analog-to-digital converter input 0.
ADC1	2	I	Analog	Analog-to-digital converter input 1.
ADC2	3	I	Analog	Analog-to-digital converter input 2.
ADC3	4	I	Analog	Analog-to-digital converter input 3.
ADC4	48	I	Analog	ADC 4 input
ADC5	47	I	Analog	ADC 5 input
ADC6	46	I	Analog	ADC 6 input
ADC7	45	I	Analog	ADC 7 input
CCP0	29	I/O	TTL	Capture/Compare/PWM 0
CCP1	13	I/O	TTL	Capture/Compare/PWM 1
CCP2	30	I/O	TTL	Capture/Compare/PWM 2
CCP3	12	I/O	TTL	Capture/Compare/PWM 3
CCP4	11	I/O	TTL	Capture/Compare/PWM 4
CCP5	43	I/O	TTL	Capture/Compare/PWM 5
GND	8	-	Power	Ground reference for logic and I/O pins.
GND	16	-	Power	Ground reference for logic and I/O pins.
GND	24	-	Power	Ground reference for logic and I/O pins.
GND	31	-	Power	Ground reference for logic and I/O pins.
I2CSCL	33	I/O	OD	I2C module 0 clock
I2CSDA	34	I/O	OD	I2C module 0 data
LDO	6	-	Power	Low drop-out regulator output voltage. This pin requires an external capacitor between the pin and GND of 1 μ F or greater.
OSC0	9	I	Analog	Main oscillator crystal input or an external clock reference input.
OSC1	10	O	Analog	Main oscillator crystal output.
PA0	17	I/O	TTL	GPIO port A bit 0
PA1	18	I/O	TTL	GPIO port A bit 1
PA2	19	I/O	TTL	GPIO port A bit 2
PA3	20	I/O	TTL	GPIO port A bit 3
PA4	21	I/O	TTL	GPIO port A bit 4
PA5	22	I/O	TTL	GPIO port A bit 5
PB0	29	I/O	TTL	GPIO port B bit 0
PB1	30	I/O	TTL	GPIO port B bit 1
PB2	33	I/O	TTL	GPIO port B bit 2
PB3	34	I/O	TTL	GPIO port B bit 3

Pin Name	Pin Number	Pin Type	Buffer Type	Description
PB4	44	I/O	TTL	GPIO port B bit 4
PB5	43	I/O	TTL	GPIO port B bit 5
PB6	42	I/O	TTL	GPIO port B bit 6
PB7	41	I/O	TTL	GPIO port B bit 7
PC0	40	I/O	TTL	GPIO port C bit 0
PC1	39	I/O	TTL	GPIO port C bit 1
PC2	38	I/O	TTL	GPIO port C bit 2
PC3	37	I/O	TTL	GPIO port C bit 3
PC4	14	I/O	TTL	GPIO port C bit 4
PC5	13	I/O	TTL	GPIO port C bit 5
PC6	12	I/O	TTL	GPIO port C bit 6
PC7	11	I/O	TTL	GPIO port C bit 7
PD0	25	I/O	TTL	GPIO port D bit 0
PD1	26	I/O	TTL	GPIO port D bit 1
PD2	27	I/O	TTL	GPIO port D bit 2
PD3	28	I/O	TTL	GPIO port D bit 3
PE0	35	I/O	TTL	GPIO port E bit 0
PE1	36	I/O	TTL	GPIO port E bit 1
RST	5	I	TTL	System reset input.
SSIClk	19	I/O	TTL	SSI clock
SSIFss	20	I/O	TTL	SSI frame
SSIRx	21	I	TTL	SSI module 0 receive
SSITx	22	O	TTL	SSI module 0 transmit
SWCLK	40	I	TTL	JTAG/SWD CLK
SWDIO	39	I/O	TTL	JTAG TMS and SWDIO
SWO	37	O	TTL	JTAG TDO and SWO
TCK	40	I	TTL	JTAG/SWD CLK
TDI	38	I	TTL	JTAG TDI
TDO	37	O	TTL	JTAG TDO and SWO
TMS	39	I/O	TTL	JTAG TMS and SWDIO
TRST	41	I	TTL	JTAG TRSTn
U0Rx	17	I	TTL	UART module 0 receive
U0Tx	18	O	TTL	UART module 0 transmit
U1Rx	27	I	TTL	UART module 1 receive. When in IrDA mode, this signal has IrDA modulation.
U1Tx	28	O	TTL	UART module 1 transmit. When in IrDA mode, this signal has IrDA modulation.
VDD	7	-	Power	Positive supply for I/O and some logic.
VDD	15	-	Power	Positive supply for I/O and some logic.
VDD	23	-	Power	Positive supply for I/O and some logic.
VDD	32	-	Power	Positive supply for I/O and some logic.

Table 16-3. Signals by Function, Except for GPIO

Function	Pin Name	Pin Number	Pin Type	Buffer Type	Description
ADC	ADC0	1	I	Analog	Analog-to-digital converter input 0.
	ADC1	2	I	Analog	Analog-to-digital converter input 1.
	ADC2	3	I	Analog	Analog-to-digital converter input 2.
	ADC3	4	I	Analog	Analog-to-digital converter input 3.
	ADC4	48	I	Analog	ADC 4 input
	ADC5	47	I	Analog	ADC 5 input
	ADC6	46	I	Analog	ADC 6 input
	ADC7	45	I	Analog	ADC 7 input
General-Purpose Timers	CCP0	29	I/O	TTL	Capture/Compare/PWM 0
	CCP1	13	I/O	TTL	Capture/Compare/PWM 1
	CCP2	30	I/O	TTL	Capture/Compare/PWM 2
	CCP3	12	I/O	TTL	Capture/Compare/PWM 3
	CCP4	11	I/O	TTL	Capture/Compare/PWM 4
	CCP5	43	I/O	TTL	Capture/Compare/PWM 5
I2C	I2CSCL	33	I/O	OD	I2C module 0 clock
	I2CSDA	34	I/O	OD	I2C module 0 data
JTAG/SWD/SWO	SWCLK	40	I	TTL	JTAG/SWD CLK
	SWDIO	39	I/O	TTL	JTAG TMS and SWDIO
	SWO	37	O	TTL	JTAG TDO and SWO
	TCK	40	I	TTL	JTAG/SWD CLK
	TDI	38	I	TTL	JTAG TDI
	TDO	37	O	TTL	JTAG TDO and SWO
	TMS	39	I/O	TTL	JTAG TMS and SWDIO
Power	GND	8	-	Power	Ground reference for logic and I/O pins.
	GND	16	-	Power	Ground reference for logic and I/O pins.
	GND	24	-	Power	Ground reference for logic and I/O pins.
	GND	31	-	Power	Ground reference for logic and I/O pins.
	LDO	6	-	Power	Low drop-out regulator output voltage. This pin requires an external capacitor between the pin and GND of 1 μ F or greater.
	VDD	7	-	Power	Positive supply for I/O and some logic.
	VDD	15	-	Power	Positive supply for I/O and some logic.
	VDD	23	-	Power	Positive supply for I/O and some logic.
	VDD	32	-	Power	Positive supply for I/O and some logic.
SSI	SSIClk	19	I/O	TTL	SSI clock
	SSIFss	20	I/O	TTL	SSI frame
	SSIRx	21	I	TTL	SSI module 0 receive
	SSITx	22	O	TTL	SSI module 0 transmit
System Control & Clocks	OSC0	9	I	Analog	Main oscillator crystal input or an external clock reference input.
	OSC1	10	O	Analog	Main oscillator crystal output.

Function	Pin Name	Pin Number	Pin Type	Buffer Type	Description
	$\overline{\text{RST}}$	5	I	TTL	System reset input.
	$\overline{\text{TRST}}$	41	I	TTL	JTAG TRSTn
UART	U0Rx	17	I	TTL	UART module 0 receive
	U0Tx	18	O	TTL	UART module 0 transmit
	U1Rx	27	I	TTL	UART module 1 receive. When in IrDA mode, this signal has IrDA modulation.
	U1Tx	28	O	TTL	UART module 1 transmit. When in IrDA mode, this signal has IrDA modulation.

Table 16-4. GPIO Pins and Alternate Functions

GPIO Pin	Pin Number	Multiplexed Function	Multiplexed Function
PA0	17	U0Rx	
PA1	18	U0Tx	
PA2	19	SSIClk	
PA3	20	SSIFss	
PA4	21	SSIRx	
PA5	22	SSITx	
PB0	29	CCP0	
PB1	30	CCP2	
PB2	33	I2CSCL	
PB3	34	I2CSDA	
PB4	44		
PB5	43	CCP5	
PB6	42		
PB7	41	$\overline{\text{TRST}}$	
PC0	40	TCK	SWCLK
PC1	39	TMS	SWDIO
PC2	38	TDI	
PC3	37	TDO	SWO
PC4	14		
PC5	13	CCP1	
PC6	12	CCP3	
PC7	11	CCP4	
PD0	25		
PD1	26		
PD2	27	U1Rx	
PD3	28	U1Tx	
PE0	35		
PE1	36		

17 Operating Characteristics

Table 17-1. Temperature Characteristics

Characteristic ^a	Symbol	Value	Unit
Industrial operating temperature range	T_A	-40 to +85	°C
Extended operating temperature range	T_A	-40 to +105	°C

a. Maximum storage temperature is 150°C.

Table 17-2. Thermal Characteristics

Characteristic	Symbol	Value	Unit
Thermal resistance (junction to ambient) ^a	θ_{JA}	50	°C/W
Average junction temperature ^b	T_J	$T_A + (P_{AVG} \cdot \theta_{JA})$	°C
Maximum junction temperature	T_{JMAX}	115 _c	°C

a. Junction to ambient thermal resistance θ_{JA} numbers are determined by a package simulator.

b. Power dissipation is a function of temperature.

c. T_{JMAX} calculation is based on power consumption values and conditions as specified in "Power Specifications" on page 383 of the data sheet.

18 Electrical Characteristics

18.1 DC Characteristics

18.1.1 Maximum Ratings

The maximum ratings are the limits to which the device can be subjected without permanently damaging the device.

Note: The device is not guaranteed to operate properly at the maximum ratings.

Table 18-1. Maximum Ratings

Characteristic ^a	Symbol	Value	Unit
Supply voltage range (V_{DD})	V_{DD}	0.0 to +3.6	V
Input voltage	V_{IN}	-0.3 to 5.5	V
Maximum current for pins, excluding pins operating as GPIOs	I	100	mA
Maximum current for GPIO pins	I	100	mA

a. Voltages are measured with respect to GND.

Important: This device contains circuitry to protect the inputs against damage due to high-static voltages or electric fields; however, it is advised that normal precautions be taken to avoid application of any voltage higher than maximum-rated voltages to this high-impedance circuit. Reliability of operation is enhanced if unused inputs are connected to an appropriate logic voltage level (for example, either GND or V_{DD}).

18.1.2 Recommended DC Operating Conditions

Table 18-2. Recommended DC Operating Conditions

Parameter	Parameter Name	Min	Nom	Max	Unit
V_{DD}	Supply voltage	3.0	3.3	3.6	V
V_{IH}	High-level input voltage	2.0	-	5.0	V
V_{IL}	Low-level input voltage	-0.3	-	1.3	V
V_{SIH}	High-level input voltage for Schmitt trigger inputs	$0.8 * V_{DD}$	-	V_{DD}	V
V_{SIL}	Low-level input voltage for Schmitt trigger inputs	0	-	$0.2 * V_{DD}$	V
V_{OH}	High-level output voltage	2.4	-	-	V
V_{OL}	Low-level output voltage	-	-	0.4	V
I_{OH}	High-level source current, $V_{OH}=2.4$ V				
	2-mA Drive	2.0	-	-	mA
	4-mA Drive	4.0	-	-	mA
	8-mA Drive	8.0	-	-	mA
I_{OL}	Low-level sink current, $V_{OL}=0.4$ V				
	2-mA Drive	2.0	-	-	mA
	4-mA Drive	4.0	-	-	mA
	8-mA Drive	8.0	-	-	mA

18.1.3 On-Chip Low Drop-Out (LDO) Regulator Characteristics

Table 18-3. LDO Regulator Characteristics

Parameter	Parameter Name	Min	Nom	Max	Unit
V _{LDOOUT}	Programmable internal (logic) power supply output value	2.25	-	2.75	V
	Output voltage accuracy	-	2%	-	%
t _{PON}	Power-on time	-	-	100	μs
t _{ON}	Time on	-	-	200	μs
t _{OFF}	Time off	-	-	100	μs
V _{STEP}	Step programming incremental voltage	-	50	-	mV
C _{LDO}	External filter capacitor size for internal power supply	1.0	-	3.0	μF

18.1.4 Power Specifications

The power measurements specified in the tables that follow are run on the core processor using SRAM with the following specifications (except as noted):

- V_{DD} = 3.3 V
- Temperature = 25°C

Table 18-4. Detailed Power Specifications

Parameter	Parameter Name	Conditions	Nom	Max	Unit
I _{DD_RUN}	Run mode 1 (Flash loop)	LDO = 2.50 V Code = while(1){} executed in Flash Peripherals = All clock-gated ON System Clock = 50 MHz (with PLL)	95	110	mA
	Run mode 2 (Flash loop)	LDO = 2.50 V Code = while(1){} executed in Flash Peripherals = All clock-gated OFF System Clock = 50 MHz (with PLL)	60	75	mA
	Run mode 1 (SRAM loop)	LDO = 2.50 V Code = while(1){} executed in SRAM Peripherals = All clock-gated ON System Clock = 50 MHz (with PLL)	85	95	mA
	Run mode 2 (SRAM loop)	LDO = 2.50 V Code = while(1){} executed in SRAM Peripherals = All clock-gated OFF System Clock = 50 MHz (with PLL)	50	60	mA
I _{DD_SLEEP}	Sleep mode	LDO = 2.50 V Peripherals = All clock-gated OFF System Clock = 50 MHz (with PLL)	19	22	mA

Parameter	Parameter Name	Conditions	Nom	Max	Unit
I _{DD_DEEPSLEEP}	Deep-Sleep mode	LDO = 2.25 V Peripherals = All OFF System Clock = MOSC/16	950	1150	μA

18.1.5 Flash Memory Characteristics

Table 18-5. Flash Memory Characteristics

Parameter	Parameter Name	Min	Nom	Max	Unit
PE _{CYC}	Number of guaranteed program/erase cycles before failure ^a	10,000	100,000	-	cycles
T _{RET}	Data retention at average operating temperature of 85°C (industrial) or 105°C (extended)	10	-	-	years
T _{PROG}	Word program time	20	-	-	μs
T _{ERASE}	Page erase time	20	-	-	ms
T _{ME}	Mass erase time	200	-	-	ms

a. A program/erase cycle is defined as switching the bits from 1-> 0 -> 1.

18.2 AC Characteristics

18.2.1 Load Conditions

Unless otherwise specified, the following conditions are true for all timing measurements. Timing measurements are for 4-mA drive strength.

Figure 18-1. Load Conditions

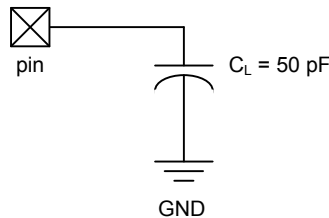

18.2.2 Clocks

Table 18-6. Phase Locked Loop (PLL) Characteristics

Parameter	Parameter Name	Min	Nom	Max	Unit
f _{ref_crystal}	Crystal reference ^a	3.579545	-	8.192	MHz
f _{ref_ext}	External clock reference ^a	3.579545	-	8.192	MHz
f _{pll}	PLL frequency ^b	-	200	-	MHz
T _{READY}	PLL lock time	-	-	0.5	ms

a. The exact value is determined by the crystal value programmed into the XTAL field of the Run-Mode Clock Configuration (RCC) register.

b. PLL frequency is automatically calculated by the hardware based on the XTAL field of the RCC register.

Table 18-7. Clock Characteristics

Parameter	Parameter Name	Min	Nom	Max	Unit
f _{IOSC}	Internal oscillator frequency	7	12	22	MHz
f _{MOSC}	Main oscillator frequency	1	-	8	MHz
t _{MOSC_per}	Main oscillator period	125	-	1000	ns
f _{ref_crystal_bypass} ^a	Crystal reference using the main oscillator (PLL in BYPASS mode)	1	-	8	MHz
f _{ref_ext_bypass}	External clock reference (PLL in BYPASS mode) ^a	0	-	50	MHz
f _{system_clock}	System clock	0	-	50	MHz

a. The ADC must be clocked from the PLL or directly from a 14-MHz to 18-MHz clock source to operate properly.

18.2.3 Analog-to-Digital Converter

Table 18-8. ADC Characteristics

Parameter	Parameter Name	Min	Nom	Max	Unit
V _{ADCIN}	Maximum single-ended, full-scale analog input voltage	-	-	3.0	V
	Minimum single-ended, full-scale analog input voltage	-	-	0	V
	Maximum differential, full-scale analog input voltage	-	-	1.5	V
	Minimum differential, full-scale analog input voltage	-	-	-1.5	V
C _{ADCIN}	Equivalent input capacitance	-	1	-	pF
N	Resolution	-	10	-	bits
f _{ADC}	ADC internal clock frequency	14	16	18	MHz
t _{ADCCONV}	Conversion time	-	-	16	t _{ADCcycles} ^a
f _{ADCCONV}	Conversion rate	875	1000	1125	k samples/s
INL	Integral nonlinearity	-	-	±1	LSB
DNL	Differential nonlinearity	-	-	±1	LSB
OFF	Offset	-	-	±1	LSB
GAIN	Gain	-	-	±1	LSB

a. t_{ADC} = 1/f_{ADC clock}

18.2.4 I²C

Table 18-9. I²C Characteristics

Parameter No.	Parameter	Parameter Name	Min	Nom	Max	Unit
I1 ^a	t _{SCH}	Start condition hold time	36	-	-	system clocks
I2 ^a	t _{LP}	Clock Low period	36	-	-	system clocks
I3 ^b	t _{SRT}	I ² C SCL/I ² C SDA rise time (V _{IL} = 0.5 V to V _{IH} = 2.4 V)	-	-	(see note b)	ns
I4 ^a	t _{DH}	Data hold time	2	-	-	system clocks
I5 ^c	t _{SFT}	I ² C SCL/I ² C SDA fall time (V _{IH} = 2.4 V to V _{IL} = 0.5 V)	-	9	10	ns
I6 ^a	t _{HT}	Clock High time	24	-	-	system clocks
I7 ^a	t _{DS}	Data setup time	18	-	-	system clocks
I8 ^a	t _{SCSR}	Start condition setup time (for repeated start condition only)	36	-	-	system clocks

Parameter No.	Parameter	Parameter Name	Min	Nom	Max	Unit
I9 ^a	t _{SCS}	Stop condition setup time	24	-	-	system clocks

- a. Values depend on the value programmed into the TPR bit in the I²C Master Timer Period (I2CMTPR) register; a TPR programmed for the maximum I2CSCL frequency (TPR=0x2) results in a minimum output timing as shown in the table above. The I²C interface is designed to scale the actual data transition time to move it to the middle of the I2CSCL Low period. The actual position is affected by the value programmed into the TPR; however, the numbers given in the above values are minimum values.
- b. Because I2CSCL and I2CSDA are open-drain-type outputs, which the controller can only actively drive Low, the time I2CSCL or I2CSDA takes to reach a high level depends on external signal capacitance and pull-up resistor values.
- c. Specified at a nominal 50 pF load.

Figure 18-2. I²C Timing

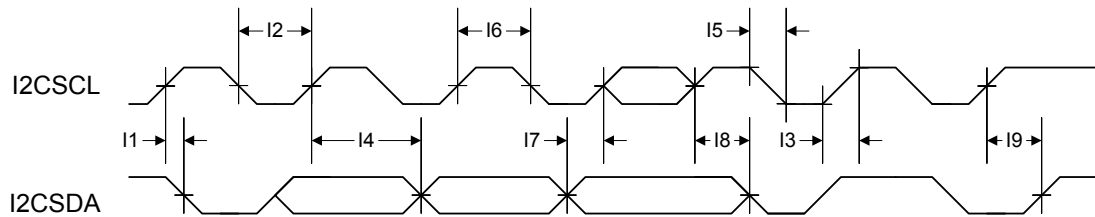

18.2.5 Synchronous Serial Interface (SSI)

Table 18-10. SSI Characteristics

Parameter No.	Parameter	Parameter Name	Min	Nom	Max	Unit
S1	t _{clk_per}	SSIClk cycle time	2	-	65024	system clocks
S2	t _{clk_high}	SSIClk high time	-	1/2	-	t clk_per
S3	t _{clk_low}	SSIClk low time	-	1/2	-	t clk_per
S4	t _{clkrf}	SSIClk rise/fall time	-	7.4	26	ns
S5	t _{DMd}	Data from master valid delay time	0	-	20	ns
S6	t _{DMs}	Data from master setup time	20	-	-	ns
S7	t _{DMh}	Data from master hold time	40	-	-	ns
S8	t _{DSs}	Data from slave setup time	20	-	-	ns
S9	t _{DSh}	Data from slave hold time	40	-	-	ns

Figure 18-3. SSI Timing for TI Frame Format (FRF=01), Single Transfer Timing Measurement

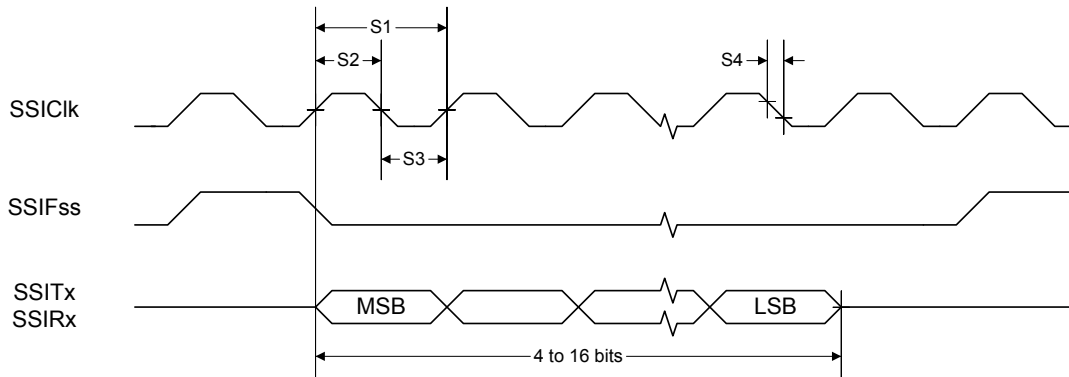

Figure 18-4. SSI Timing for MICROWIRE Frame Format (FRF=10), Single Transfer

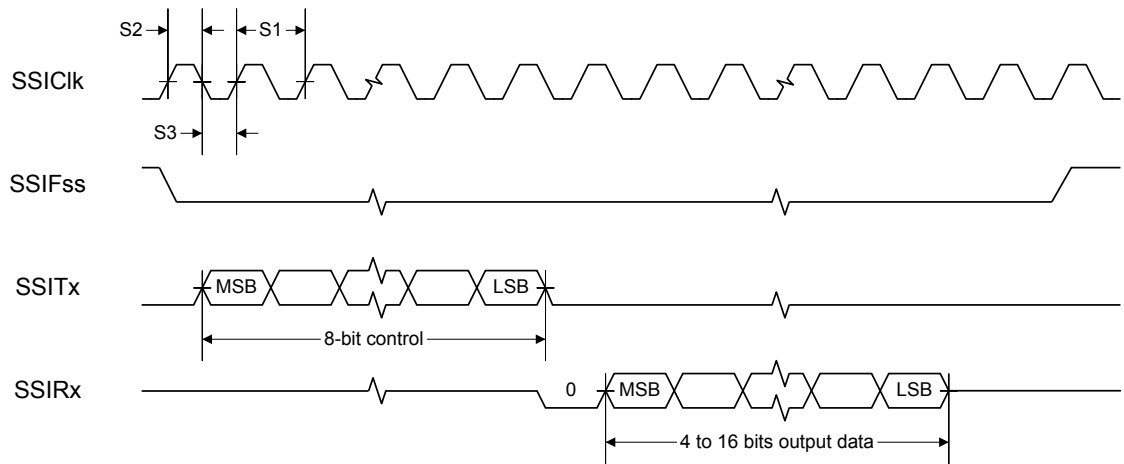
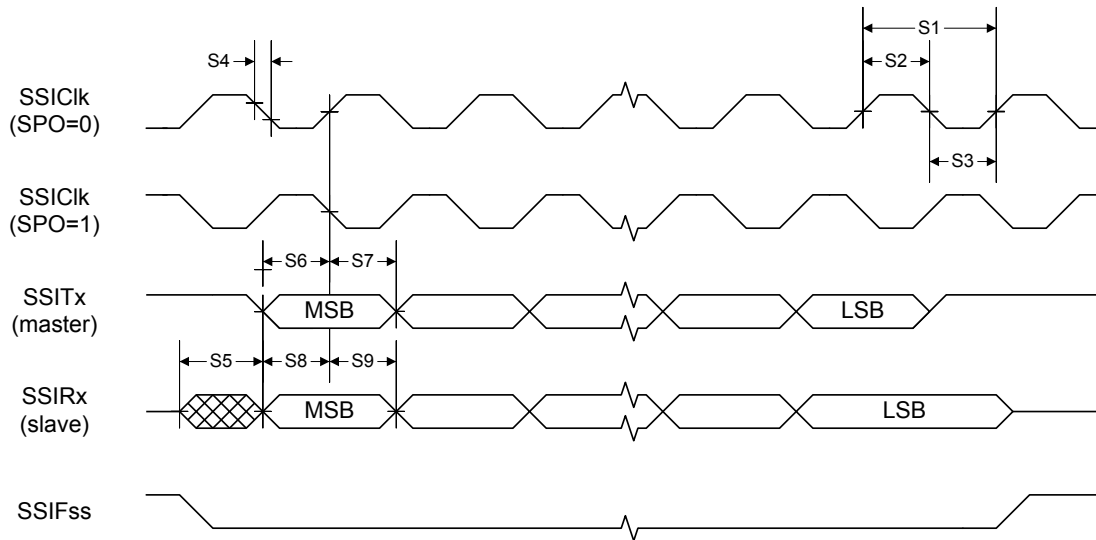

Figure 18-5. SSI Timing for SPI Frame Format (FRF=00), with SPH=1



18.2.6 JTAG and Boundary Scan

Table 18-11. JTAG Characteristics

Parameter No.	Parameter	Parameter Name	Min	Nom	Max	Unit	
J1	f_{TCK}	TCK operational clock frequency	0	-	10	MHz	
J2	t_{TCK}	TCK operational clock period	100	-	-	ns	
J3	t_{TCK_LOW}	TCK clock Low time	-	t_{TCK}	-	ns	
J4	t_{TCK_HIGH}	TCK clock High time	-	t_{TCK}	-	ns	
J5	t_{TCK_R}	TCK rise time	0	-	10	ns	
J6	t_{TCK_F}	TCK fall time	0	-	10	ns	
J7	t_{TMS_SU}	TMS setup time to TCK rise	20	-	-	ns	
J8	t_{TMS_HLD}	TMS hold time from TCK rise	20	-	-	ns	
J9	t_{TDI_SU}	TDI setup time to TCK rise	25	-	-	ns	
J10	t_{TDI_HLD}	TDI hold time from TCK rise	25	-	-	ns	
J11	t_{TDO_ZDV}	TCK fall to Data Valid from High-Z	-	2-mA drive	23	35	ns
		4-mA drive		15	26	ns	
		8-mA drive		14	25	ns	
		8-mA drive with slew rate control		18	29	ns	
J12	t_{TDO_DV}	TCK fall to Data Valid from Data Valid	-	2-mA drive	21	35	ns
		4-mA drive		14	25	ns	
		8-mA drive		13	24	ns	
		8-mA drive with slew rate control		18	28	ns	

Parameter No.	Parameter	Parameter Name	Min	Nom	Max	Unit
J13	TCK fall to High-Z from Data Valid	2-mA drive	-	9	11	ns
		4-mA drive		7	9	ns
		8-mA drive		6	8	ns
		8-mA drive with slew rate control		7	9	ns
J14	t_{TRST}	\overline{TRST} assertion time	100	-	-	ns
J15	t_{TRST_SU}	\overline{TRST} setup time to TCK rise	10	-	-	ns

Figure 18-6. JTAG Test Clock Input Timing

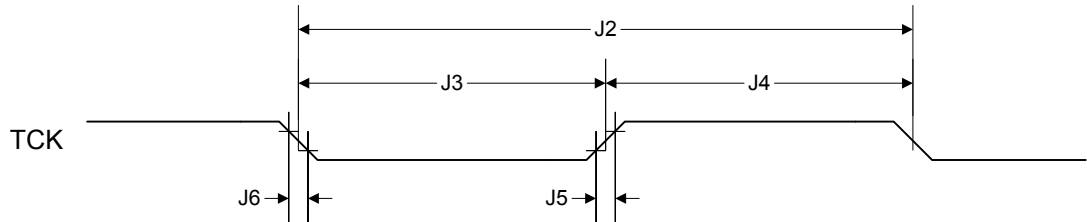

Figure 18-7. JTAG Test Access Port (TAP) Timing

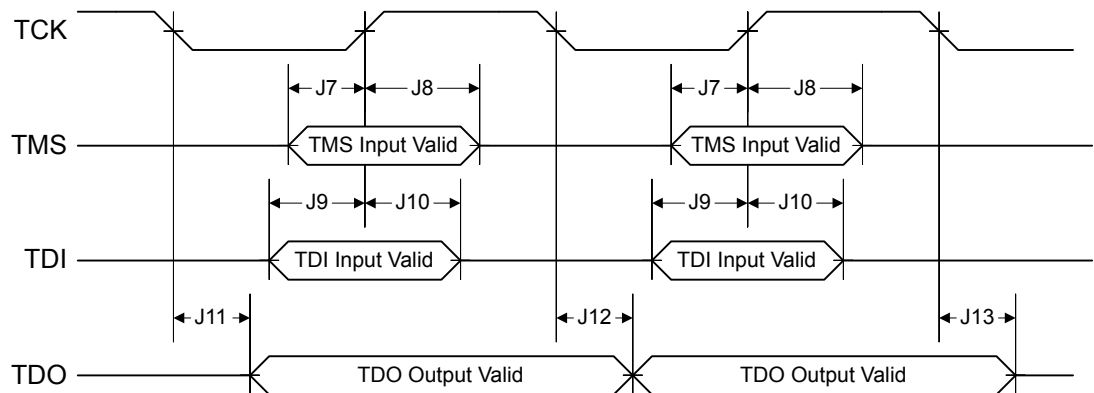
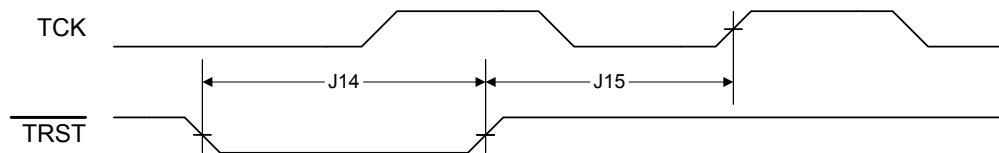

Figure 18-8. JTAG TRST Timing



18.2.7 General-Purpose I/O

Note: All GPIOs are 5 V-tolerant.

Table 18-12. GPIO Characteristics

Parameter	Parameter Name	Condition	Min	Nom	Max	Unit
t _{GPIOR}	GPIO Rise Time (from 20% to 80% of V _{DD})	2-mA drive	-	17	26	ns
		4-mA drive		9	13	ns
		8-mA drive		6	9	ns
		8-mA drive with slew rate control		10	12	ns
t _{GPIOF}	GPIO Fall Time (from 80% to 20% of V _{DD})	2-mA drive	-	17	25	ns
		4-mA drive		8	12	ns
		8-mA drive		6	10	ns
		8-mA drive with slew rate control		11	13	ns

18.2.8 Reset

Table 18-13. Reset Characteristics

Parameter No.	Parameter	Parameter Name	Min	Nom	Max	Unit
R1	V _{TH}	Reset threshold	-	2.0	-	V
R2	V _{BTH}	Brown-Out threshold	2.85	2.9	2.95	V
R3	T _{POR}	Power-On Reset timeout	-	10	-	ms
R4	T _{BOR}	Brown-Out timeout	-	500	-	μs
R5	T _{IRPOR}	Internal reset timeout after POR	15	-	30	ms
R6	T _{IRBOR}	Internal reset timeout after BOR ^a	2.5	-	20	μs
R7	T _{IRHWR}	Internal reset timeout after hardware reset ($\overline{\text{RST}}$ pin)	15	-	30	ms
R8	T _{IRSWR}	Internal reset timeout after software-initiated system reset ^a	2.5	-	20	μs
R9	T _{IRWDR}	Internal reset timeout after watchdog reset ^a	2.5	-	20	μs
R10	T _{IRLDOR}	Internal reset timeout after LDO reset ^a	2.5	-	20	μs
R11	T _{VDDRISE}	Supply voltage (V _{DD}) rise time (0 V-3.3 V)	-	-	100	ms

a. 20 * t_{MOSC_per}

Figure 18-9. External Reset Timing ($\overline{\text{RST}}$)

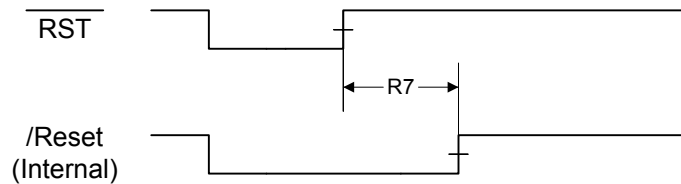

Figure 18-10. Power-On Reset Timing

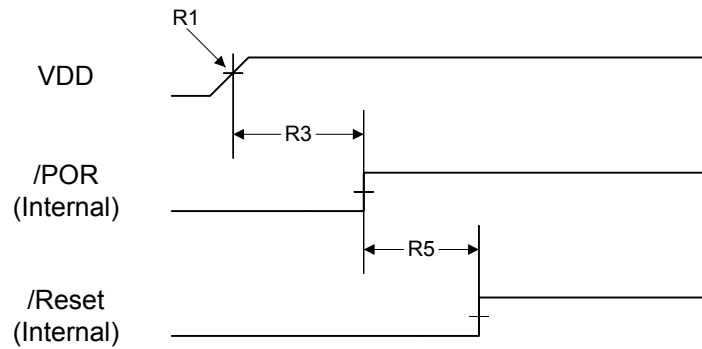

Figure 18-11. Brown-Out Reset Timing

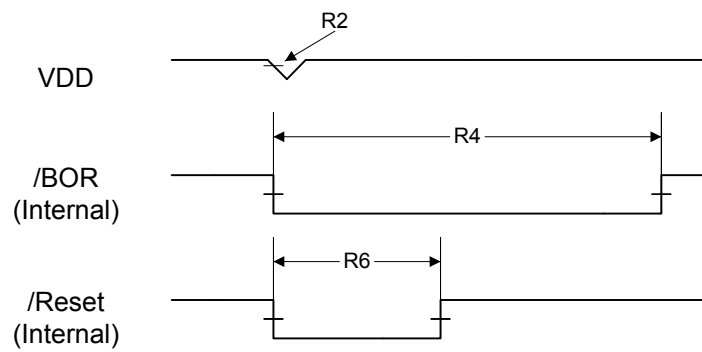

Figure 18-12. Software Reset Timing

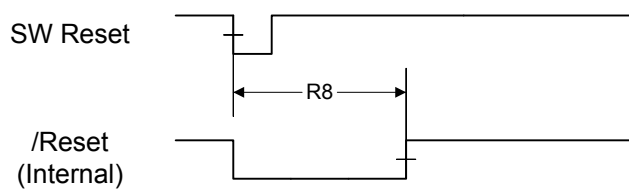

Figure 18-13. Watchdog Reset Timing

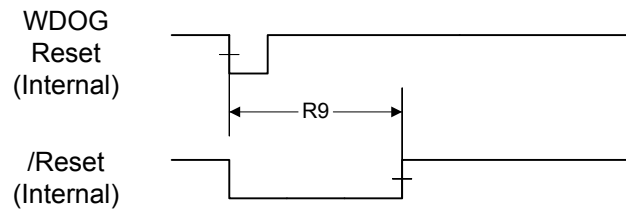
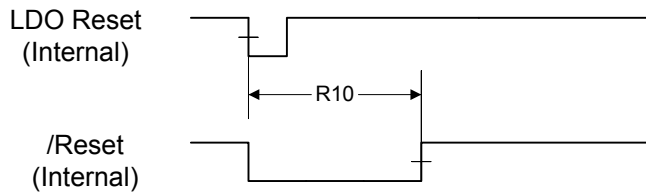
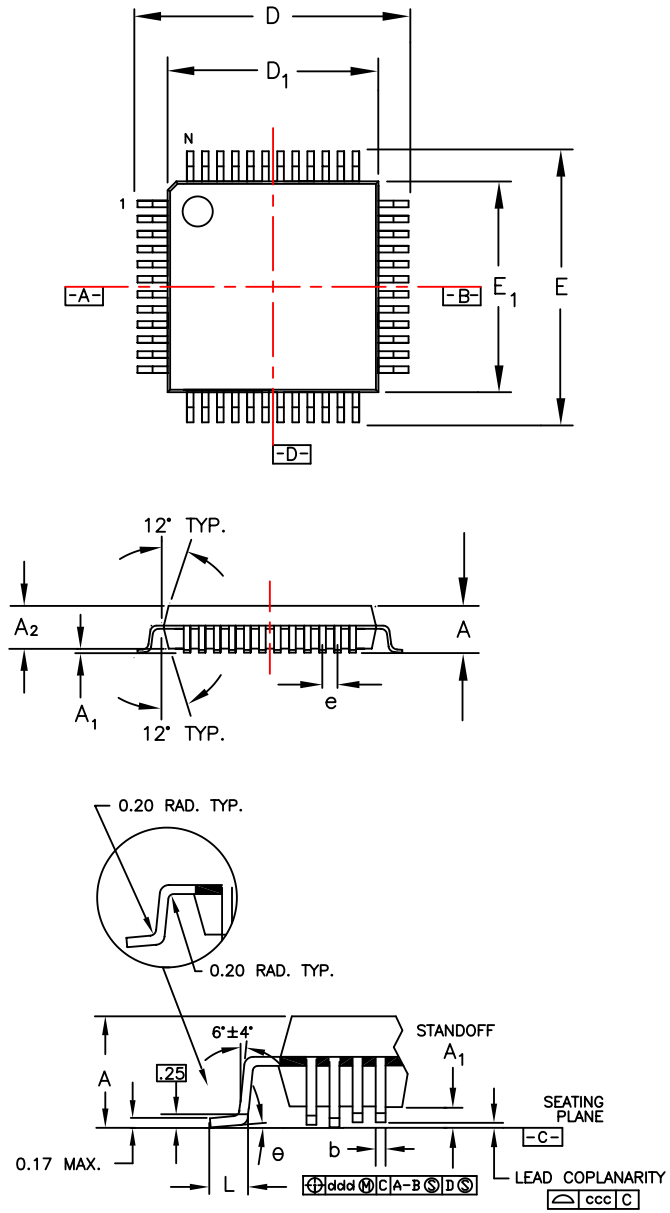

Figure 18-14. LDO Reset Timing



19 Package Information

Figure 19-1. 48-Pin LQFP Package



Note: The following notes apply to the package drawing.

1. All dimensions are in mm.
2. Dimensions shown are nominal with tolerances indicated.
3. Foot length "L" is measured at gage plane 0.25 mm above seating plane.

4. L/F: Eftec 64T Cu or equivalent, 0.127 mm (0.005") thick.

Symbol	Package Type		Note
	48LD LQFP		
	MIN	MAX	
A	-	1.60	
A ₁	0.05	0.15	
A ₂	-	1.40	
D	9.00		
D ₁	7.00		
E	9.00		
E ₁	7.00		
L	0.60		
e	0.50		
b	0.22		
theta	0° - 7°		
ddd	0.08		
ccc	0.08		
JEDEC Reference Drawing		MS-026	
Variation Designator		BBC	

A Serial Flash Loader

A.1 Serial Flash Loader

The Stellaris[®] serial flash loader is a preprogrammed flash-resident utility used to download code to the flash memory of a device without the use of a debug interface. The serial flash loader uses a simple packet interface to provide synchronous communication with the device. The flash loader runs off the crystal and does not enable the PLL, so its speed is determined by the crystal used. The two serial interfaces that can be used are the UART0 and SSI0 interfaces. For simplicity, both the data format and communication protocol are identical for both serial interfaces.

A.2 Interfaces

Once communication with the flash loader is established via one of the serial interfaces, that interface is used until the flash loader is reset or new code takes over. For example, once you start communicating using the SSI port, communications with the flash loader via the UART are disabled until the device is reset.

A.2.1 UART

The Universal Asynchronous Receivers/Transmitters (UART) communication uses a fixed serial format of 8 bits of data, no parity, and 1 stop bit. The baud rate used for communication is automatically detected by the flash loader and can be any valid baud rate supported by the host and the device. The auto detection sequence requires that the baud rate should be no more than 1/32 the crystal frequency of the board that is running the serial flash loader. This is actually the same as the hardware limitation for the maximum baud rate for any UART on a Stellaris[®] device which is calculated as follows:

$$\text{Max Baud Rate} = \text{System Clock Frequency} / 16$$

In order to determine the baud rate, the serial flash loader needs to determine the relationship between its own crystal frequency and the baud rate. This is enough information for the flash loader to configure its UART to the same baud rate as the host. This automatic baud-rate detection allows the host to use any valid baud rate that it wants to communicate with the device.

The method used to perform this automatic synchronization relies on the host sending the flash loader two bytes that are both 0x55. This generates a series of pulses to the flash loader that it can use to calculate the ratios needed to program the UART to match the host's baud rate. After the host sends the pattern, it attempts to read back one byte of data from the UART. The flash loader returns the value of 0xCC to indicate successful detection of the baud rate. If this byte is not received after at least twice the time required to transfer the two bytes, the host can resend another pattern of 0x55, 0x55, and wait for the 0xCC byte again until the flash loader acknowledges that it has received a synchronization pattern correctly. For example, the time to wait for data back from the flash loader should be calculated as at least $2 * (20(\text{bits}/\text{sync}) / \text{baud rate} (\text{bits}/\text{sec}))$. For a baud rate of 115200, this time is $2 * (20 / 115200)$ or 0.35 ms.

A.2.2 SSI

The Synchronous Serial Interface (SSI) port also uses a fixed serial format for communications, with the framing defined as Motorola format with SPH set to 1 and SPO set to 1. See "Frame Formats" on page 296 in the SSI chapter for more information on formats for this transfer protocol. Like the UART, this interface has hardware requirements that limit the maximum speed that the SSI clock can run. This allows the SSI clock to be at most 1/12 the crystal frequency of the board running

the flash loader. Since the host device is the master, the SSI on the flash loader device does not need to determine the clock as it is provided directly by the host.

A.3 Packet Handling

All communications, with the exception of the UART auto-baud, are done via defined packets that are acknowledged (ACK) or not acknowledged (NAK) by the devices. The packets use the same format for receiving and sending packets, including the method used to acknowledge successful or unsuccessful reception of a packet.

A.3.1 Packet Format

All packets sent and received from the device use the following byte-packed format.

```
struct
{
    unsigned char ucSize;
    unsigned char ucChecksum;
    unsigned char Data[];
};
```

ucSize	The first byte received holds the total size of the transfer including the size and checksum bytes.
ucChecksum	This holds a simple checksum of the bytes in the data buffer only. The algorithm is $Data[0]+Data[1]+\dots+Data[ucSize-3]$.
Data	This is the raw data intended for the device, which is formatted in some form of command interface. There should be $ucSize-2$ bytes of data provided in this buffer to or from the device.

A.3.2 Sending Packets

The actual bytes of the packet can be sent individually or all at once; the only limitation is that commands that cause flash memory access should limit the download sizes to prevent losing bytes during flash programming. This limitation is discussed further in the section that describes the serial flash loader command, `COMMAND_SEND_DATA` (see “`COMMAND_SEND_DATA (0x24)`” on page 390).

Once the packet has been formatted correctly by the host, it should be sent out over the UART or SSI interface. Then the host should poll the UART or SSI interface for the first non-zero data returned from the device. The first non-zero byte will either be an ACK (0xCC) or a NAK (0x33) byte from the device indicating the packet was received successfully (ACK) or unsuccessfully (NAK). This does not indicate that the actual contents of the command issued in the data portion of the packet were valid, just that the packet was received correctly.

A.3.3 Receiving Packets

The flash loader sends a packet of data in the same format that it receives a packet. The flash loader may transfer leading zero data before the first actual byte of data is sent out. The first non-zero byte is the size of the packet followed by a checksum byte, and finally followed by the data itself. There is no break in the data after the first non-zero byte is sent from the flash loader. Once the device communicating with the flash loader receives all the bytes, it must either ACK or NAK the packet to indicate that the transmission was successful. The appropriate response after sending a NAK to the flash loader is to resend the command that failed and request the data again. If needed, the host may send leading zeros before sending down the ACK/NAK signal to the flash loader, as the

flash loader only accepts the first non-zero data as a valid response. This zero padding is needed by the SSI interface in order to receive data to or from the flash loader.

A.4 Commands

The next section defines the list of commands that can be sent to the flash loader. The first byte of the data should always be one of the defined commands, followed by data or parameters as determined by the command that is sent.

A.4.1 COMMAND_PING (0x20)

This command simply accepts the command and sets the global status to success. The format of the packet is as follows:

```
Byte[0] = 0x03;
Byte[1] = checksum(Byte[2]);
Byte[2] = COMMAND_PING;
```

The ping command has 3 bytes and the value for `COMMAND_PING` is 0x20 and the checksum of one byte is that same byte, making `Byte[1]` also 0x20. Since the ping command has no real return status, the receipt of an ACK can be interpreted as a successful ping to the flash loader.

A.4.2 COMMAND_GET_STATUS (0x23)

This command returns the status of the last command that was issued. Typically, this command should be sent after every command to ensure that the previous command was successful or to properly respond to a failure. The command requires one byte in the data of the packet and should be followed by reading a packet with one byte of data that contains a status code. The last step is to ACK or NAK the received data so the flash loader knows that the data has been read.

```
Byte[0] = 0x03
Byte[1] = checksum(Byte[2])
Byte[2] = COMMAND_GET_STATUS
```

A.4.3 COMMAND_DOWNLOAD (0x21)

This command is sent to the flash loader to indicate where to store data and how many bytes will be sent by the `COMMAND_SEND_DATA` commands that follow. The command consists of two 32-bit values that are both transferred MSB first. The first 32-bit value is the address to start programming data into, while the second is the 32-bit size of the data that will be sent. This command also triggers an erase of the full area to be programmed so this command takes longer than other commands. This results in a longer time to receive the ACK/NAK back from the board. This command should be followed by a `COMMAND_GET_STATUS` to ensure that the Program Address and Program size are valid for the device running the flash loader.

The format of the packet to send this command is as follows:

```
Byte[0] = 11
Byte[1] = checksum(Bytes[2:10])
Byte[2] = COMMAND_DOWNLOAD
Byte[3] = Program Address [31:24]
Byte[4] = Program Address [23:16]
Byte[5] = Program Address [15:8]
Byte[6] = Program Address [7:0]
Byte[7] = Program Size [31:24]
```

```
Byte[8] = Program Size [23:16]
Byte[9] = Program Size [15:8]
Byte[10] = Program Size [7:0]
```

A.4.4 **COMMAND_SEND_DATA (0x24)**

This command should only follow a `COMMAND_DOWNLOAD` command or another `COMMAND_SEND_DATA` command if more data is needed. Consecutive send data commands automatically increment address and continue programming from the previous location. The caller should limit transfers of data to a maximum 8 bytes of packet data to allow the flash to program successfully and not overflow input buffers of the serial interfaces. The command terminates programming once the number of bytes indicated by the `COMMAND_DOWNLOAD` command has been received. Each time this function is called it should be followed by a `COMMAND_GET_STATUS` to ensure that the data was successfully programmed into the flash. If the flash loader sends a NAK to this command, the flash loader does not increment the current address to allow retransmission of the previous data.

```
Byte[0] = 11
Byte[1] = checksum(Bytes[2:10])
Byte[2] = COMMAND_SEND_DATA
Byte[3] = Data[0]
Byte[4] = Data[1]
Byte[5] = Data[2]
Byte[6] = Data[3]
Byte[7] = Data[4]
Byte[8] = Data[5]
Byte[9] = Data[6]
Byte[10] = Data[7]
```

A.4.5 **COMMAND_RUN (0x22)**

This command is used to tell the flash loader to execute from the address passed as the parameter in this command. This command consists of a single 32-bit value that is interpreted as the address to execute. The 32-bit value is transmitted MSB first and the flash loader responds with an ACK signal back to the host device before actually executing the code at the given address. This allows the host to know that the command was received successfully and the code is now running.

```
Byte[0] = 7
Byte[1] = checksum(Bytes[2:6])
Byte[2] = COMMAND_RUN
Byte[3] = Execute Address[31:24]
Byte[4] = Execute Address[23:16]
Byte[5] = Execute Address[15:8]
Byte[6] = Execute Address[7:0]
```

A.4.6 **COMMAND_RESET (0x25)**

This command is used to tell the flash loader device to reset. This is useful when downloading a new image that overwrote the flash loader and wants to start from a full reset. Unlike the `COMMAND_RUN` command, this allows the initial stack pointer to be read by the hardware and set up for the new code. It can also be used to reset the flash loader if a critical error occurs and the host device wants to restart communication with the flash loader.

```
Byte[0] = 3  
Byte[1] = checksum(Byte[2])  
Byte[2] = COMMAND_RESET
```

The flash loader responds with an ACK signal back to the host device before actually executing the software reset to the device running the flash loader. This allows the host to know that the command was received successfully and the part will be reset.

B Register Quick Reference

31	30	29	28	27	26	25	24	23	22	21	20	19	18	17	16						
15	14	13	12	11	10	9	8	7	6	5	4	3	2	1	0						
System Control																					
Base 0x400F.E000																					
DID0, type RO, offset 0x000, reset -																					
VER				MAJOR				MINOR													
PBORCTL, type R/W, offset 0x030, reset 0x0000.7FFD																					
BORTIM												BORIOR		BORWT							
LDOCTL, type R/W, offset 0x034, reset 0x0000.0000																					
												VADJ									
RIS, type RO, offset 0x050, reset 0x0000.0000																					
								PLLRIS		CLRIS		IOFRIS		MOFRIS		LDORIS		BORRIS		PLFRIS	
IMC, type R/W, offset 0x054, reset 0x0000.0000																					
								PLLLIM		CLIM		IOFIM		MOFIM		LDOIM		BORIM		PLLFIM	
MISC, type R/W1C, offset 0x058, reset 0x0000.0000																					
								PLLMIS		CLMIS		IOFMIS		MOFMIS		LDOMIS		BORMIS			
RESC, type R/W, offset 0x05C, reset -																					
								LDO		SW		WDT		BOR		POR		EXT			
RCC, type R/W, offset 0x060, reset 0x0780.3AC0																					
				ACG		SYSDIV				USESYSDIV											
PWRDN		OEN		BYPASS		PLLVER		XTAL				OSCSRC		IOSCOVER		MOSCOVER		IOSCDIS		MOSCDIS	
PLLCFG, type RO, offset 0x064, reset -																					
OD				F								R									
DSLCLKCFG, type R/W, offset 0x144, reset 0x0780.0000																					
												IOSC									
CLKVCLR, type R/W, offset 0x150, reset 0x0000.0000																					
												VERCLR									
LDOARST, type R/W, offset 0x160, reset 0x0000.0000																					
												LDOARST									
DID1, type RO, offset 0x004, reset -																					
VER				FAM				PARTNO													
								TEMP				PKG		ROHS		QUAL					
DC0, type RO, offset 0x008, reset 0x001F.001F																					
												SRAMSZ									
												FLASHSZ									
DC1, type RO, offset 0x010, reset 0x0001.33BF																					
MINSYSDIV				MAXADCSPD				MPU		TEMPSNS		PLL		WDT		SWO		SWD		ADC	
																				JTAG	
DC2, type RO, offset 0x014, reset 0x0007.1013																					
				I2CO								SSI0		TIMER2		TIMER1		TIMER0			
																UART1		UART0			

31	30	29	28	27	26	25	24	23	22	21	20	19	18	17	16
15	14	13	12	11	10	9	8	7	6	5	4	3	2	1	0
FMC, type R/W, offset 0x008, reset 0x0000.0000															
WRKEY															
												COMT	MERASE	ERASE	WRITE
FCRIS, type RO, offset 0x00C, reset 0x0000.0000															
														PRIS	ARIS
FCIM, type R/W, offset 0x010, reset 0x0000.0000															
														PMASK	AMASK
FCMISC, type R/W1C, offset 0x014, reset 0x0000.0000															
														PMISC	AMISC
Internal Memory															
Flash Registers (System Control Offset)															
Base 0x400F.E000															
USECRL, type R/W, offset 0x140, reset 0x31															
														USEC	
FMPRE, type R/W, offset 0x130, reset 0xBFFF.FFFF															
READ_ENABLE															
READ_ENABLE															
FMPPE, type R/W, offset 0x134, reset 0xFFFF.FFFF															
PROG_ENABLE															
PROG_ENABLE															
General-Purpose Input/Outputs (GPIOs)															
GPIO Port A base: 0x4000.4000															
GPIO Port B base: 0x4000.5000															
GPIO Port C base: 0x4000.6000															
GPIO Port D base: 0x4000.7000															
GPIO Port E base: 0x4002.4000															
GPIODATA, type R/W, offset 0x000, reset 0x0000.0000															
														DATA	
GPDIR, type R/W, offset 0x400, reset 0x0000.0000															
														DIR	
GPIOIS, type R/W, offset 0x404, reset 0x0000.0000															
														IS	
GPIOIBE, type R/W, offset 0x408, reset 0x0000.0000															
														IBE	
GPIOIEV, type R/W, offset 0x40C, reset 0x0000.0000															
														IEV	
GPIOIM, type R/W, offset 0x410, reset 0x0000.0000															
														IME	
GPORIS, type RO, offset 0x414, reset 0x0000.0000															
														RIS	
GPOMIS, type RO, offset 0x418, reset 0x0000.0000															
														MIS	

31	30	29	28	27	26	25	24	23	22	21	20	19	18	17	16
15	14	13	12	11	10	9	8	7	6	5	4	3	2	1	0
GPIOICR, type W1C, offset 0x41C, reset 0x0000.0000															
												IC			
GPIOAFSEL, type R/W, offset 0x420, reset -															
												AFSEL			
GPIODR2R, type R/W, offset 0x500, reset 0x0000.00FF															
												DRV2			
GPIODR4R, type R/W, offset 0x504, reset 0x0000.0000															
												DRV4			
GPIODR8R, type R/W, offset 0x508, reset 0x0000.0000															
												DRV8			
GPIODR, type R/W, offset 0x50C, reset 0x0000.0000															
												ODE			
GPIOPUR, type R/W, offset 0x510, reset 0x0000.00FF															
												PUE			
GPIOPDR, type R/W, offset 0x514, reset 0x0000.0000															
												PDE			
GPIOSLR, type R/W, offset 0x518, reset 0x0000.0000															
												SRL			
GPIODEN, type R/W, offset 0x51C, reset 0x0000.00FF															
												DEN			
GPIOPeriphID4, type RO, offset 0xFD0, reset 0x0000.0000															
												PID4			
GPIOPeriphID5, type RO, offset 0xFD4, reset 0x0000.0000															
												PID5			
GPIOPeriphID6, type RO, offset 0xFD8, reset 0x0000.0000															
												PID6			
GPIOPeriphID7, type RO, offset 0xFDC, reset 0x0000.0000															
												PID7			
GPIOPeriphID0, type RO, offset 0xFE0, reset 0x0000.0061															
												PID0			
GPIOPeriphID1, type RO, offset 0xFE4, reset 0x0000.0000															
												PID1			
GPIOPeriphID2, type RO, offset 0xFE8, reset 0x0000.0018															
												PID2			

31	30	29	28	27	26	25	24	23	22	21	20	19	18	17	16	
15	14	13	12	11	10	9	8	7	6	5	4	3	2	1	0	
GPIOPeriphID3, type RO, offset 0xFEC, reset 0x0000.0001																
												PID3				
GPIOCellID0, type RO, offset 0xFF0, reset 0x0000.000D																
												CID0				
GPIOCellID1, type RO, offset 0xFF4, reset 0x0000.00F0																
												CID1				
GPIOCellID2, type RO, offset 0xFF8, reset 0x0000.0005																
												CID2				
GPIOCellID3, type RO, offset 0xFFC, reset 0x0000.00B1																
												CID3				
General-Purpose Timers																
Timer0 base: 0x4003.0000																
Timer1 base: 0x4003.1000																
Timer2 base: 0x4003.2000																
GPTMCFG, type R/W, offset 0x000, reset 0x0000.0000																
												GPTMCFG				
GPTMTAMR, type R/W, offset 0x004, reset 0x0000.0000																
												TAAMS	TACMR	TAMR		
GPTMTBMR, type R/W, offset 0x008, reset 0x0000.0000																
												TBAMS	TBCMR	TBMR		
GPTMCTL, type R/W, offset 0x00C, reset 0x0000.0000																
TBPWML		TBOTE	TBEVENT			TBSTALL	TBEN	TAPWML			TAOTE	RTCEN	TAEVENT		TASTALL	TAEN
GPTMIMR, type R/W, offset 0x018, reset 0x0000.0000																
						CBEIM	CBMIM	TBTOIM				RTCIM	CAEIM	CAMIM	TATOIM	
GPTMRIS, type RO, offset 0x01C, reset 0x0000.0000																
						CBERIS	CBMRIS	TBTORIS				RTCIS	CAERIS	CAMRIS	TATORIS	
GPTMMIS, type RO, offset 0x020, reset 0x0000.0000																
						CBEMIS	CBMMIS	TBTOMIS				RTCMIS	CAEMIS	CAMMIS	TATOMIS	
GPTMICR, type W1C, offset 0x024, reset 0x0000.0000																
						CBECINT	CBMCINT	TBTCINT				RTCCINT	CAECINT	CAMCINT	TATOCINT	
GPTMTAILR, type R/W, offset 0x028, reset 0x0000.FFFF (16-bit mode) and 0xFFFF.FFFF (32-bit mode)																
												TAILRH				
												TAILRL				
GPTMTBILR, type R/W, offset 0x02C, reset 0x0000.FFFF																
												TBILRL				
GPTMTAMATCHR, type R/W, offset 0x030, reset 0x0000.FFFF (16-bit mode) and 0xFFFF.FFFF (32-bit mode)																
												TAMRH				
												TAMRL				

31	30	29	28	27	26	25	24	23	22	21	20	19	18	17	16
15	14	13	12	11	10	9	8	7	6	5	4	3	2	1	0
GPTMTBMATCHR, type R/W, offset 0x034, reset 0x0000.FFFF															
TBMR															
GPTMTAPR, type R/W, offset 0x038, reset 0x0000.0000															
TAPSR															
GPTMTBPR, type R/W, offset 0x03C, reset 0x0000.0000															
TBPSR															
GPTMTAPMR, type R/W, offset 0x040, reset 0x0000.0000															
TAPSMR															
GPTMTBPMR, type R/W, offset 0x044, reset 0x0000.0000															
TBPSMR															
GPTMTAR, type RO, offset 0x048, reset 0x0000.FFFF (16-bit mode) and 0xFFFF.FFFF (32-bit mode)															
TARH															
TARL															
GPTMTBR, type RO, offset 0x04C, reset 0x0000.FFFF															
TBRL															
Watchdog Timer															
Base 0x4000.0000															
WDTLOAD, type R/W, offset 0x000, reset 0xFFFF.FFFF															
WDTLoad															
WDTLoad															
WDTVALUE, type RO, offset 0x004, reset 0xFFFF.FFFF															
WDTValue															
WDTValue															
WDTCTL, type R/W, offset 0x008, reset 0x0000.0000															
														RESEN	INTEN
WDTICR, type WO, offset 0x00C, reset -															
WDTIntClr															
WDTIntClr															
WDTRIS, type RO, offset 0x010, reset 0x0000.0000															
WDTRIS															
WDTMIS, type RO, offset 0x014, reset 0x0000.0000															
WDTMIS															
WDTTEST, type R/W, offset 0x418, reset 0x0000.0000															
STALL															
WDTLOCK, type R/W, offset 0xC00, reset 0x0000.0000															
WDTLock															
WDTLock															
WDTPeriphID4, type RO, offset 0xFD0, reset 0x0000.0000															
PID4															
WDTPeriphID5, type RO, offset 0xFD4, reset 0x0000.0000															
PID5															

31	30	29	28	27	26	25	24	23	22	21	20	19	18	17	16
15	14	13	12	11	10	9	8	7	6	5	4	3	2	1	0
WDTPeriphID6, type RO, offset 0xFD8, reset 0x0000.0000															
												PID6			
WDTPeriphID7, type RO, offset 0xFDC, reset 0x0000.0000															
												PID7			
WDTPeriphID0, type RO, offset 0xFE0, reset 0x0000.0005															
												PID0			
WDTPeriphID1, type RO, offset 0xFE4, reset 0x0000.0018															
												PID1			
WDTPeriphID2, type RO, offset 0xFE8, reset 0x0000.0018															
												PID2			
WDTPeriphID3, type RO, offset 0xFEC, reset 0x0000.0001															
												PID3			
WDTPCellID0, type RO, offset 0xFF0, reset 0x0000.000D															
												CID0			
WDTPCellID1, type RO, offset 0xFF4, reset 0x0000.00F0															
												CID1			
WDTPCellID2, type RO, offset 0xFF8, reset 0x0000.0005															
												CID2			
WDTPCellID3, type RO, offset 0xFFC, reset 0x0000.00B1															
												CID3			
Analog-to-Digital Converter (ADC) Base 0x4003.8000															
ADCACTSS, type R/W, offset 0x000, reset 0x0000.0000															
												ASEN3	ASEN2	ASEN1	ASEN0
ADCRIS, type RO, offset 0x004, reset 0x0000.0000															
												INR3	INR2	INR1	INR0
ADCIM, type R/W, offset 0x008, reset 0x0000.0000															
												MASK3	MASK2	MASK1	MASK0
ADCISC, type R/W1C, offset 0x00C, reset 0x0000.0000															
												IN3	IN2	IN1	IN0
ADCOSTAT, type R/W1C, offset 0x010, reset 0x0000.0000															
												OV3	OV2	OV1	OV0
ADCEMUX, type R/W, offset 0x014, reset 0x0000.0000															
EM3				EM2				EM1				EM0			
ADCUSTAT, type R/W1C, offset 0x018, reset 0x0000.0000															
												UV3	UV2	UV1	UV0

31	30	29	28	27	26	25	24	23	22	21	20	19	18	17	16				
15	14	13	12	11	10	9	8	7	6	5	4	3	2	1	0				
ADCSSPRI, type R/W, offset 0x020, reset 0x0000.3210																			
SS3				SS2				SS1				SS0							
ADCPSSI, type WO, offset 0x028, reset -																			
												SS3		SS2		SS1		SS0	
ADCSAC, type R/W, offset 0x030, reset 0x0000.0000																			
														AVG					
ADCSSMUX0, type R/W, offset 0x040, reset 0x0000.0000																			
MUX7				MUX6				MUX5				MUX4							
MUX3				MUX2				MUX1				MUX0							
ADCSSCTL0, type R/W, offset 0x044, reset 0x0000.0000																			
TS7	IE7	END7	D7	TS6	IE6	END6	D6	TS5	IE5	END5	D5	TS4	IE4	END4	D4				
TS3	IE3	END3	D3	TS2	IE2	END2	D2	TS1	IE1	END1	D1	TS0	IE0	END0	D0				
ADCSSFIFO0, type RO, offset 0x048, reset 0x0000.0000																			
														DATA					
ADCSSFIFO1, type RO, offset 0x068, reset 0x0000.0000																			
														DATA					
ADCSSFIFO2, type RO, offset 0x088, reset 0x0000.0000																			
														DATA					
ADCSSFIFO3, type RO, offset 0x0A8, reset 0x0000.0000																			
														DATA					
ADCSSFSTAT0, type RO, offset 0x04C, reset 0x0000.0100																			
FULL				EMPTY				HPTR				TPTR							
ADCSSFSTAT1, type RO, offset 0x06C, reset 0x0000.0100																			
FULL				EMPTY				HPTR				TPTR							
ADCSSFSTAT2, type RO, offset 0x08C, reset 0x0000.0100																			
FULL				EMPTY				HPTR				TPTR							
ADCSSFSTAT3, type RO, offset 0x0AC, reset 0x0000.0100																			
FULL				EMPTY				HPTR				TPTR							
ADCSSMUX1, type R/W, offset 0x060, reset 0x0000.0000																			
MUX3				MUX2				MUX1				MUX0							
ADCSSMUX2, type R/W, offset 0x080, reset 0x0000.0000																			
MUX3				MUX2				MUX1				MUX0							
ADCSSCTL1, type R/W, offset 0x064, reset 0x0000.0000																			
TS3	IE3	END3	D3	TS2	IE2	END2	D2	TS1	IE1	END1	D1	TS0	IE0	END0	D0				
ADCSSCTL2, type R/W, offset 0x084, reset 0x0000.0000																			
TS3	IE3	END3	D3	TS2	IE2	END2	D2	TS1	IE1	END1	D1	TS0	IE0	END0	D0				

31	30	29	28	27	26	25	24	23	22	21	20	19	18	17	16	
15	14	13	12	11	10	9	8	7	6	5	4	3	2	1	0	
ADCSSMUX3, type R/W, offset 0x0A0, reset 0x0000.0000																
												MUX0				
ADCSSCTL3, type R/W, offset 0x0A4, reset 0x0000.0002																
												TS0	IE0	END0	D0	
ADCTMLB, type R/W, offset 0x100, reset 0x0000.0000																
															LB	
Universal Asynchronous Receivers/Transmitters (UARTs) UART0 base: 0x4000.C000 UART1 base: 0x4000.D000																
UARTDR, type R/W, offset 0x000, reset 0x0000.0000																
				OE	BE	PE	FE	DATA								
UARTSR/UARTECR, type RO, offset 0x004, reset 0x0000.0000																
												OE	BE	PE	FE	
UARTSR/UARTECR, type WO, offset 0x004, reset 0x0000.0000																
												DATA				
UARTFR, type RO, offset 0x018, reset 0x0000.0090																
								TXFE	RXFF	TXFF	RXFE	BUSY				
UARTIBRD, type R/W, offset 0x024, reset 0x0000.0000																
															DIVINT	
UARTFBRD, type R/W, offset 0x028, reset 0x0000.0000																
															DIVFRAC	
UARTLCRH, type R/W, offset 0x02C, reset 0x0000.0000																
								SPS	WLEN	FEN	STP2	EPS	PEN	BRK		
UARTCTL, type R/W, offset 0x030, reset 0x0000.0300																
				RXE	TXE	LBE					UARTEN					
UARTIFLS, type R/W, offset 0x034, reset 0x0000.0012																
												RXIFLSEL	TXIFLSEL			
UARTIM, type R/W, offset 0x038, reset 0x0000.0000																
				OEIM	BEIM	PEIM	FEIM	RTIM	TXIM	RXIM						
UARTRIS, type RO, offset 0x03C, reset 0x0000.000F																
				OERIS	BERIS	PERIS	FERIS	RTRIS	TXRIS	RXRIS						
UARTMIS, type RO, offset 0x040, reset 0x0000.0000																
				OEMIS	BEMIS	PEMIS	FEMIS	RTMIS	TXMIS	RXMIS						
UARTICR, type W1C, offset 0x044, reset 0x0000.0000																
				OEIC	BEIC	PEIC	FEIC	RTIC	TXIC	RXIC						

31	30	29	28	27	26	25	24	23	22	21	20	19	18	17	16				
15	14	13	12	11	10	9	8	7	6	5	4	3	2	1	0				
UARTPeriphID4, type RO, offset 0xFD0, reset 0x0000.0000																			
												PID4							
UARTPeriphID5, type RO, offset 0xFD4, reset 0x0000.0000																			
												PID5							
UARTPeriphID6, type RO, offset 0xFD8, reset 0x0000.0000																			
												PID6							
UARTPeriphID7, type RO, offset 0xFDC, reset 0x0000.0000																			
												PID7							
UARTPeriphID0, type RO, offset 0xFE0, reset 0x0000.0011																			
												PID0							
UARTPeriphID1, type RO, offset 0xFE4, reset 0x0000.0000																			
												PID1							
UARTPeriphID2, type RO, offset 0xFE8, reset 0x0000.0018																			
												PID2							
UARTPeriphID3, type RO, offset 0xFEC, reset 0x0000.0001																			
												PID3							
UARTPCellID0, type RO, offset 0xFF0, reset 0x0000.000D																			
												CID0							
UARTPCellID1, type RO, offset 0xFF4, reset 0x0000.00F0																			
												CID1							
UARTPCellID2, type RO, offset 0xFF8, reset 0x0000.0005																			
												CID2							
UARTPCellID3, type RO, offset 0xFFC, reset 0x0000.00B1																			
												CID3							
Synchronous Serial Interface (SSI) SSI0 base: 0x4000.8000																			
SSICR0, type R/W, offset 0x000, reset 0x0000.0000																			
SCR						SPH		SPO		FRF		DSS							
SSICR1, type R/W, offset 0x004, reset 0x0000.0000																			
												SOD		MS		SSE		LBM	
SSIDR, type R/W, offset 0x008, reset 0x0000.0000																			
DATA																			
SSISR, type RO, offset 0x00C, reset 0x0000.0003																			
										BSY		RFF		RNE		TNF		TFE	
SSICPSR, type R/W, offset 0x010, reset 0x0000.0000																			
CPSDVSR																			

31	30	29	28	27	26	25	24	23	22	21	20	19	18	17	16
15	14	13	12	11	10	9	8	7	6	5	4	3	2	1	0
SSIIM, type R/W, offset 0x014, reset 0x0000.0000															
												TXIM	RXIM	RTIM	RORIM
SSIRIS, type RO, offset 0x018, reset 0x0000.0008															
												TXRIS	RXRIS	RTRIS	RORRIS
SSIMIS, type RO, offset 0x01C, reset 0x0000.0000															
												TXMIS	RXMIS	RTMIS	RORMIS
SSIICR, type W1C, offset 0x020, reset 0x0000.0000															
														RTIC	RORIC
SSIPeriphID4, type RO, offset 0xFD0, reset 0x0000.0000															
												PID4			
SSIPeriphID5, type RO, offset 0xFD4, reset 0x0000.0000															
												PID5			
SSIPeriphID6, type RO, offset 0xFD8, reset 0x0000.0000															
												PID6			
SSIPeriphID7, type RO, offset 0xFDC, reset 0x0000.0000															
												PID7			
SSIPeriphID0, type RO, offset 0xFE0, reset 0x0000.0022															
												PID0			
SSIPeriphID1, type RO, offset 0xFE4, reset 0x0000.0000															
												PID1			
SSIPeriphID2, type RO, offset 0xFE8, reset 0x0000.0018															
												PID2			
SSIPeriphID3, type RO, offset 0xFEC, reset 0x0000.0001															
												PID3			
SSIPCellID0, type RO, offset 0xFF0, reset 0x0000.000D															
												CID0			
SSIPCellID1, type RO, offset 0xFF4, reset 0x0000.00F0															
												CID1			
SSIPCellID2, type RO, offset 0xFF8, reset 0x0000.0005															
												CID2			
SSIPCellID3, type RO, offset 0xFFC, reset 0x0000.00B1															
												CID3			

31	30	29	28	27	26	25	24	23	22	21	20	19	18	17	16			
15	14	13	12	11	10	9	8	7	6	5	4	3	2	1	0			
Inter-Integrated Circuit (I²C) Interface																		
I²C Master																		
I2C Master 0 base: 0x4002.0000																		
I2CMSA, type R/W, offset 0x000, reset 0x0000.0000																		
												SA		R/S				
I2CMCS, type RO, offset 0x004, reset 0x0000.0000																		
												BUSBSY	IDLE	ARBLST	DATAACK	ADRACK	ERROR	BUSY
I2CMCS, type WO, offset 0x004, reset 0x0000.0000																		
												ACK	STOP	START	RUN			
I2CMDR, type R/W, offset 0x008, reset 0x0000.0000																		
												DATA						
I2CMTPR, type R/W, offset 0x00C, reset 0x0000.0001																		
												TPR						
I2CMIMR, type R/W, offset 0x010, reset 0x0000.0000																		
												IM						
I2CMRIS, type RO, offset 0x014, reset 0x0000.0000																		
												RIS						
I2CMMIS, type RO, offset 0x018, reset 0x0000.0000																		
												MIS						
I2CMICR, type WO, offset 0x01C, reset 0x0000.0000																		
												IC						
I2CMCR, type R/W, offset 0x020, reset 0x0000.0000																		
												SFE	MFE			LPBK		
Inter-Integrated Circuit (I²C) Interface																		
I²C Slave																		
I2CSOAR, type R/W, offset 0x000, reset 0x0000.0000																		
												OAR						
I2CCSR, type RO, offset 0x004, reset 0x0000.0000																		
												FBR	TREQ	RREQ				
I2CCSR, type WO, offset 0x004, reset 0x0000.0000																		
												DA						
I2CSDR, type R/W, offset 0x008, reset 0x0000.0000																		
												DATA						
I2CSIMR, type R/W, offset 0x00C, reset 0x0000.0000																		
												DATAIM						

Register Quick Reference

31	30	29	28	27	26	25	24	23	22	21	20	19	18	17	16
15	14	13	12	11	10	9	8	7	6	5	4	3	2	1	0
I2CSRIS, type RO, offset 0x010, reset 0x0000.0000															
															DATARIS
I2CSMIS, type RO, offset 0x014, reset 0x0000.0000															
															DATAMIS
I2CSICR, type WO, offset 0x018, reset 0x0000.0000															
															DATAIC

C Ordering and Contact Information

C.1 Ordering Information

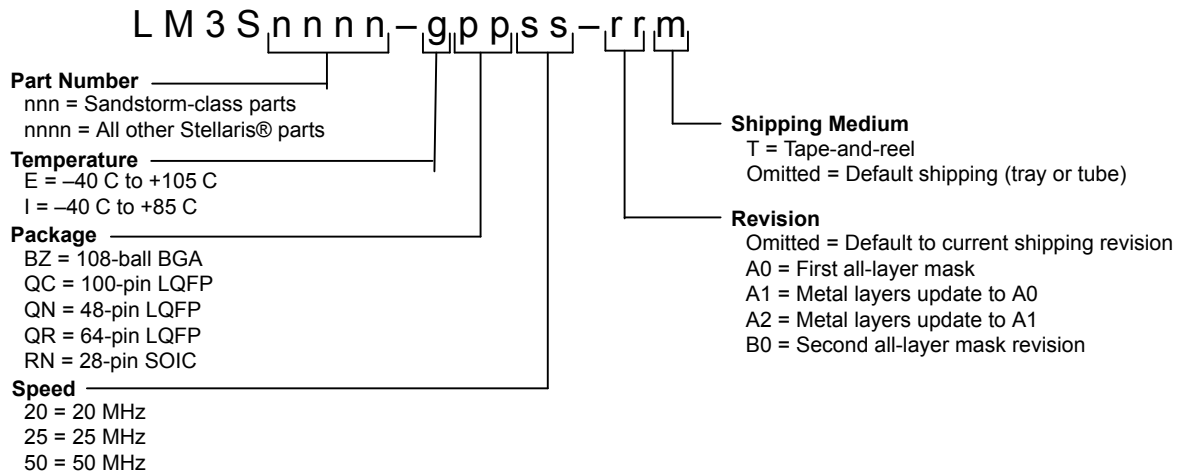

Table C-1. Part Ordering Information

Orderable Part Number	Description
LM3S828-IQN50	Stellaris® LM3S828 Microcontroller
LM3S828-IQN50(T)	Stellaris® LM3S828 Microcontroller
LM3S828-EQN50	Stellaris® LM3S828 Microcontroller
LM3S828-EQN50(T)	Stellaris® LM3S828 Microcontroller

C.2 Kits

The Luminary Micro Stellaris® Family provides the hardware and software tools that engineers need to begin development quickly.

- Reference Design Kits accelerate product development by providing ready-to-run hardware, and comprehensive documentation including hardware design files:
http://www.luminarymicro.com/products/reference_design_kits/
- Evaluation Kits provide a low-cost and effective means of evaluating Stellaris® microcontrollers before purchase:
<http://www.luminarymicro.com/products/kits.html>
- Development Kits provide you with all the tools you need to develop and prototype embedded applications right out of the box:
http://www.luminarymicro.com/products/development_kits.html

See the Luminary Micro website for the latest tools available, or ask your Luminary Micro distributor.

C.3 Company Information

Luminary Micro, Inc. designs, markets, and sells ARM Cortex-M3-based microcontrollers (MCUs). Austin, Texas-based Luminary Micro is the lead partner for the Cortex-M3 processor, delivering the world's first silicon implementation of the Cortex-M3 processor. Luminary Micro's introduction of the Stellaris® family of products provides 32-bit performance for the same price as current 8- and 16-bit microcontroller designs. With entry-level pricing at \$1.00 for an ARM technology-based MCU, Luminary Micro's Stellaris product line allows for standardization that eliminates future architectural upgrades or software tool changes.

Luminary Micro, Inc.
108 Wild Basin, Suite 350
Austin, TX 78746
Main: +1-512-279-8800
Fax: +1-512-279-8879
<http://www.luminarymicro.com>
sales@luminarymicro.com

C.4 Support Information

For support on Luminary Micro products, contact:
support@luminarymicro.com +1-512-279-8800, ext. 3